

**Manutti**

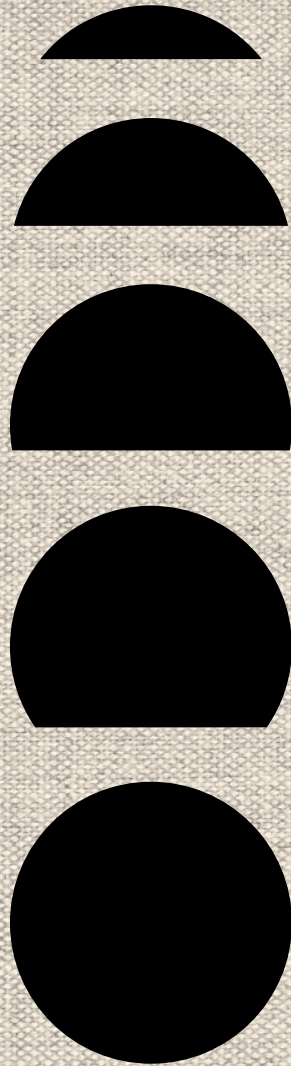

outdoor luxury



# Manutti

Manutti collections 2020



## Collections

### Furniture

Flex	30
Solid	38
Torsa	44
Kobo	48
Radius	52
Minus	58
Cascade	62
Echo	68
Duo	72
Prato	76
Kumo	78
Elements	82
Air	86
Zendo	90
Liner	94
Loop	98
Moon Island	102
San	106
Siena	110
Cross	114
River	120
Mood	124
San Diego	128
Malibu	132
Latona	136
Fuse	140
Luna	146
Trento	148
Quarto	150
Livorno	152
Milano	154
Napoli	156
Side tables	158

## Products

### Type

Chairs	172
Bar stools & stools	174
Lounge chairs	176
Sofas	178
Loungers	182
Benches	185
Tables	186

### More

Rugs	190
Outdoor lighting	190
Trolleys	190
Towel rack	190
Trays	190
Poufs	191
Umbrellas	193
Cushion boxes	193

## Technical

### Furniture

Flex	196
Solid	200
Torsa	201
Kobo	204
Radius	205
Minus	208
Cascade	210
Echo	212
Duo	213
Prato	214
Kumo	216
Elements	219
Air	222
Zendo	226
Liner	229
Loop	231
Moon Island	232
San	234
Siena	237
Cross	240
River	242
Mood	244
San Diego	246
Malibu	249
Latona	251
Fuse	252
Luna	256
Trento	257
Quarto	258
Livorno	260
Milano	262
Napoli	263
Side tables	264

### More

Rugs	265
Outdoor lighting	266
Trays	267
Poufs	269
Towel rack	270
Cushion boxes	272



<b>Intro</b>	7
<b>Moods</b>	9
<b>Designers</b>	18
<b>Collections</b>	28
<b>Craft &amp; technology</b>	164
<b>Products</b>	170
<b>Technical specifications</b>	194
<b>Materials &amp; fabrics</b>	274
<b>Protection &amp; maintenance</b>	290
<b>Outro</b>	302





A Manutti experience is a moment of joy and cosiness under the sky. Warmth and luxury for everyone, everywhere: from sunrise till sunset.

Step outside. Feel the warmth on your skin and enjoy the presence of your loved ones. At Manutti we believe in the beauty of outdoor spaces and their power to connect us. Our pieces are designed to inspire you to spend unforgettable moments outside with friends and family, at any time of the day, from dawn to dusk.

Manutti pieces are more than furniture. They are the canvas on which you'll create cosy and congenial moments. They are for everyone, every moment, and wherever in the world you may be. Whether you prefer relaxing besides the cool crisp water of your private pool, in the salty dunes near the shore, or want to bask in the serenity of nature or the vibrant atmosphere of the city: we've cultured four styles that will defy your expectations. Just sit back, relax, and get inspired.

The common themes in our designs: innovation, craftsmanship and an uncompromising eye for quality. That's why our exclusive pieces are true originals and destined to become icons. At the same time, we keep your everyday needs in mind. Each design is well-considered and consciously aligns with the practical aspects of life. We have added a graceful element of softness that will bring you into harmony with the present moment. A Manutti moment is designed to last a lifetime. Make sure you fill it with warmth, luxury and pleasure.







# Tender Earth



Our first style, tender earth, will set your spirits soaring. Enjoy the peacefulness of country life in cosy, rustic surroundings. Look around and find yourself in a world that's both dreamlike and authentic.

Stroll slowly between the olive trees in a beautiful, rolling landscape. Listen to the sounds of happily babbling brooks while the gentle scents of lavender and citrus fill the air. It's the perfect setting for a generous wine tasting after spending the day scouting the Mediterranean countryside.



# Tropical Concrete



Tropical concrete, our second style, triggers vibrant emotion. Embrace the urban vibe: chill, comfy and vibrant. Explore the grandeur and excitement of city life, with its grand boulevards, open squares and dazzling architecture.

Discover the perfect mix of old and new. Amble past impressive art deco houses surrounded by large landscaped gardens or take a stroll in one of the many flower-filled city parks. Enjoy a day on the water or connect with the cultural offering in a city that never sleeps.





# Salty Dunes



Let your mind wander with our third style, salty dunes. Picture the sand between your toes. You are relaxing at the seaside with only the sound of the waves to guide you. Doze off at sunset in the shade of the palm trees.

Immerse yourself in a feeling of simplicity and freedom while gazing over the ocean from your hammock. The wind has shaped the dunes into romantic waves, punctuated with jagged rocks, pearly white beach houses and wooden cabins. The air is filled with the tangy smell of marine salt and freshly caught fish.





# Crisp Water<sup>o</sup>



Sink into the embrace of crisp water, our final style. Imagine yourself floating under a radiant sun, listening to the sounds of joyful summer tunes and splashing water by the poolside.

Clink your glasses of bubbling champagne and fruity lemonade together as you initiate your exhilarating pool party. Dive in! Inhale the fresh, intoxicating aromas of lime and oleander, the natural scents of summer, blended with the classic holiday smells of sunscreen and chlorinated water.





**Designers'**



# Stephane De Winter

## Transcending beauty through artisanship

Designer of Torsa, Cascade, Zendo, Kobo and Radius

Good design goes hand in hand with usability and comfort. That is what inspires Manutti founder and head designer Stephane De Winter (1968). He created and guards the unique Manutti DNA: smart design, craftsmanship and a profound sense of quality. This is reflected in his Kobo, Radius and Zendo collections, featuring a mix of refined, classic designs with a contemporary twist. Always receptive to the customer's needs and in line with the latest trends, his team transcends itself to go beyond beauty.



# Koen Van Extergem

## Great in simplicity

Designer of Air, Duo & Flame

Through his elegant minimalistic style, Belgian designer Koen Van Extergem (1989) has brought a sense of purity and lightness to Manutti. He studied product development and furniture design and joined the Manutti design team in 2013. His sleek, clean-cut creations are at the heart of the Air, Flame & Duo collections: a new generation of durable outdoor solutions that are meticulously crafted, yet warm and full of character. In 2018, he was recognised with the Archiproducts Design Award for his Duo rocking chair.



# Metrica Design Studio

## International classics with an elegant twist

Designer of Flex

The Milanese design studio Metrica, headed by Lucio Quinzio Leonelli and Robin Rizzini, brings a touch of Italian flair to Manutti. Internationally acclaimed for its exclusive mixture of creation and technical management, the studio's designs are elegant and meticulously crafted. The collaboration with Manutti resulted in the Flex collection, a balancing act between traditional aesthetics and a unique, elegant shape.

# Lionel Doyen

## Beyond the aesthetics

Designer of Kumo, San & Solid

With a practical understanding of product usability and an eye for fine details, Lionel Doyen (1978) takes a slightly different approach to design and development. Specialised in service, product and industrial design, the French designer aims to create on a more personal and experimental level, always keeping the customer's experience in mind. His style can best be described as innovative and timeless, as he consistently looks beyond mere aesthetic appeal. He designed the Kumo, San & Solid collections for Manutti, blending design with everyday comfort. In 2013, he launched his own design studio.





# Gerd Couckhuyt

## Inspired by life

Designer of Elements, Mood, Loop & Moon Island

Inspired by the beauty of everyday life, Gerd Couckhuyt (1970) is an award-winning Belgian designer whose Manutti collections breathe subtlety, elegance and fun. The Mood collection comes with a touch of light and translucence. His vibrant style fits perfectly in the Loop & Moon Island collections, seamlessly combining pure lines with colourful designs. The enticing forms and alluring architecture of the Elements collection earned Manutti the 'Red Dot Award for Product Design'.



# Mads Odgård

## Functional, celebrated design

Designer of Cross

Describing himself as a 'less is more man', celebrated designer Mads Odgård (1960) is all about simplicity. His minimalist style and practical approach have earned him international acclaim: he has won several prestigious awards, including the German Design Council Award and Red Dot Germany. He graduated from The Royal Danish Academy of Fine Arts, Denmark's Design School and the Swiss Art Centre of Europe. Bringing more than 30 years of experience in his own design studio to the table, his designs are logical and joyful. His motto: 'keep it simple and the earth liveable'. For Manutti, he created the functional and ageless Cross chair.



# Bram Bollen

## **Master of simplicity**

Designer of Liner

Starting his career as a freelance outdoor designer, Belgian designer Bram Bollen (1979) has developed a penchant for simplicity and a keen eye for detail over the years. With a degree in media and design and inspired by architectural lines and interior design, he creates contemporary, refreshing works. For Manutti, he designed the perennial Liner collection, which oozes both warmth and elegance.





# Collections





# Flex<sup>o</sup>

Designed by Metrica

Flex unites a world of contrasts: limber yet strong, this collection features a light, elegant aluminum frame combined with the warmth of a handcrafted wood finish. The collection carefully balances old and new to give the pieces their defining characteristics. The unique shape of the oval legs turns the Flex sofa into a one-of-a-kind piece of furniture destined for long-lasting appreciation.

















# Solid

Designed by Lionel Doyen

Fashioned from natural teak and brushed teak nero, the Solid collection is both an invitation and a bold statement. The design of the chairs and stools perfectly balances technological innovation and authentic craftsmanship. Its graceful wooden frame and delicately crafted plush seating simultaneously suggest solidity and comfort – a sensation that is further amplified by its sensual shape, which molds to the body.















# Torsa

Designed by Stephane De Winter

Torsa is the epitome of sophistication: slender and light. The sculpted wooden base is combined with a tabletop made of faux marble or monochrome ceramic. A relaxing coffee break, a festive banquet or jolly aperitif: Torsa turns any occasion into a moment to remember. Thanks to its understated size, Torsa is apt for small or large spaces and is multi-functional.











# Kobo'

Designed by Stephane De Winter

Timeless in style, Kobo is a marvel of technical complexity. Its secret? A structure made entirely of hand-woven rope around a welded aluminum frame. The curved lines of the armchair and full-length sofa are combined with deep, plush seating for an extreme comfort.







# Radius'

Designed by Stephane De Winter

The unique, airy design of the Radius collection is perfect for exquisite moments of warmth and closeness. Its wrap-around back and armrests, made entirely out of rope, blend seamlessly and give the piece a neomodern yet timeless look and feel. Keep it sober or opt for matching backrest cushions designed for optimal seating comfort for long get-togethers.





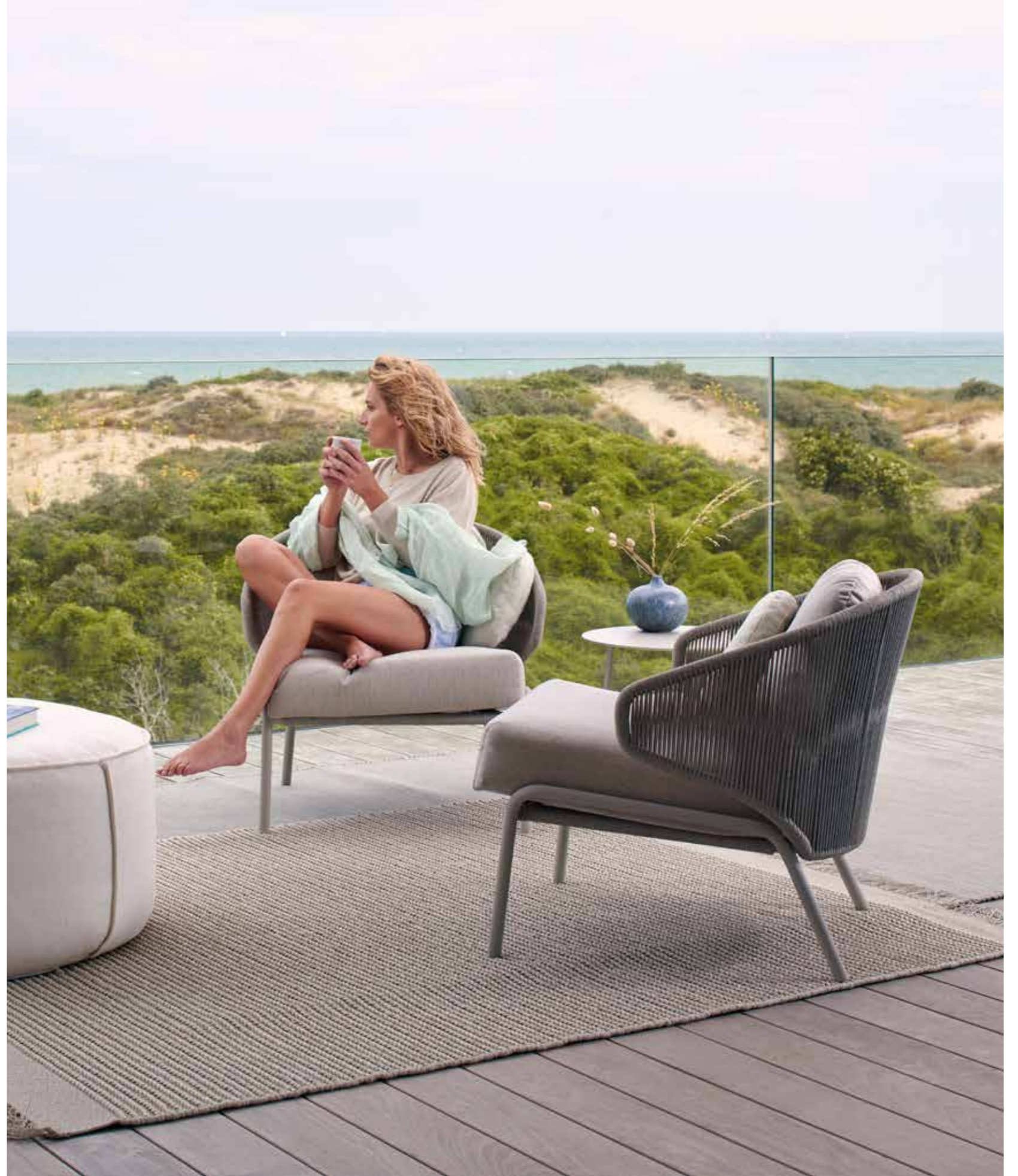









# Minus'

Designed by Stephane De Winter

With its slender design and muted, warm colours, the Minus table collection is your ideal match for a naturally intimate dining experience. Its minimal, sensual frame is sure to entice. Minus is a perfect fit with the Salty Dunes style.











# Cascade'

Designed by Stephane De Winter

By the poolside or on the terrace, the Cascade collection oozes style and comfort. Its spacious seating, finished with an intriguing mix of powder-coated aluminium and thick woven rope, make Cascade the ideal lounge solution to create lasting moments with family and friends.













# Echo<sup>o</sup>

Designed by Stephane De Winter

The ultra-light Echo armchair is an elegant mix of contemporary design and a vintage twist. The chair comes with a high, curved, rectangular backrest and a firm but supple seat in a woven rope finish, for an unparalleled seating experience.











# Duo'

Designed by Koen Van Extergem

In their durable yet airy design, the Duo chair and rocking chair radiate purity. Marked by the duality of traditional craftsmanship and meticulous metalwork, both chairs are beacons of transparency. Duo is composed of two connected frames made of bent steel, giving the impression of being held together by ropes. The Duo rocking chair is the winner of the 2018 Archiproducts Design Award in the 'Outdoor' category.











# Prato'

Designed by Stephane De Winter

With its notable elegant profiles, the Prato table collection showcases timeless beauty. The sleek shapes of Prato pieces fit effortlessly into any outdoor setting. The collection features beautiful traditional dining and coffee tables in many different finishes.





# Kumo'

Designed by Lionel Doyen

Kumo is a light and playful contemporary seating island. Japanese for cloud, Kumo invites you to create your personalised outdoor cocoon. It comes in different shapes and sizes. The movable armrests and back supports are easily adjusted to create either a comfortable sofa or stylish lounge chair, a luxurious lounge chair or a relaxing footrest.

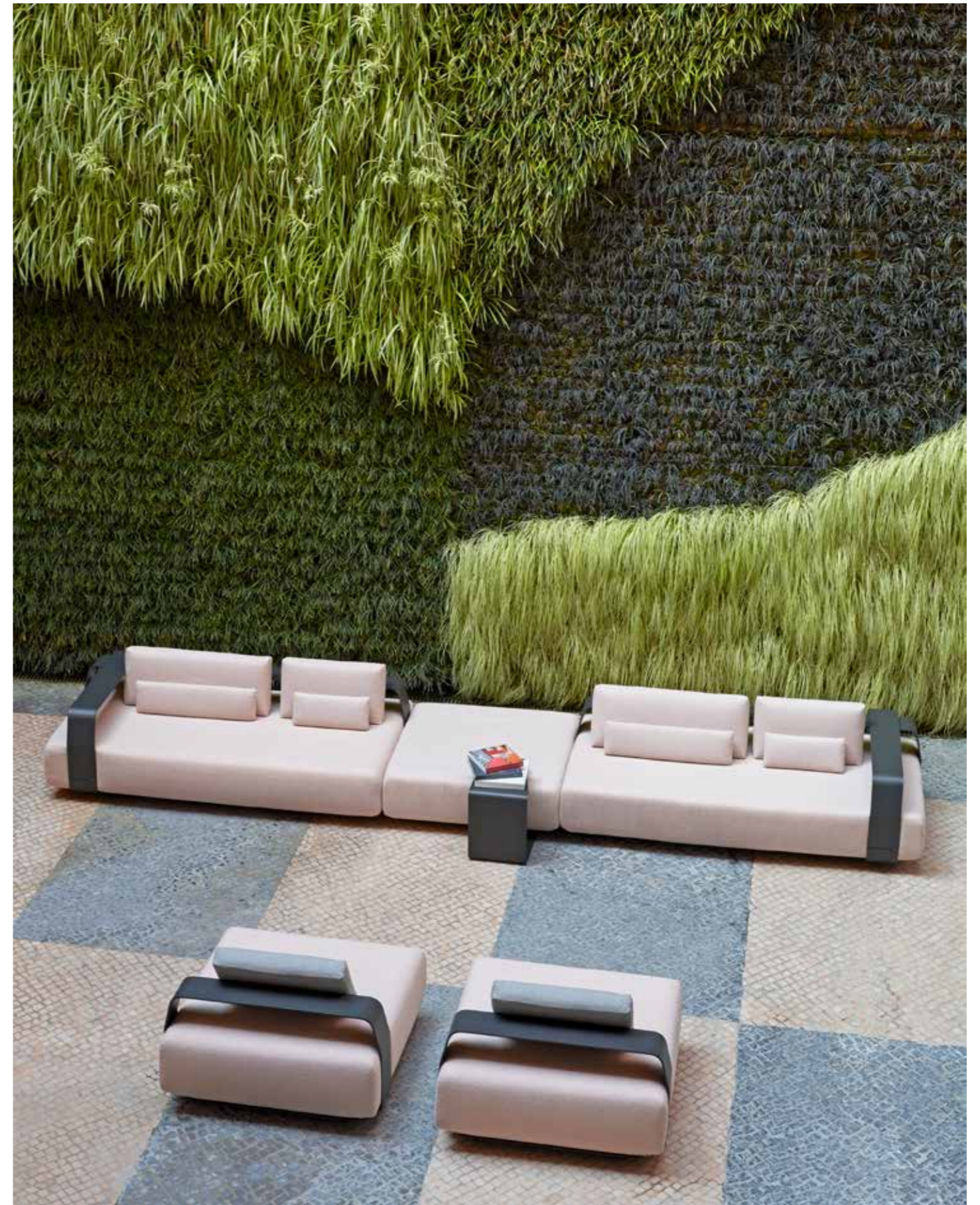









# Elements'

Designed by Gerd Couckhuyt

With its inviting form and fascinating design, the Elements seating island is a sight for sore eyes. This ultra-modular and movable seating concept allows for endless arrangement options, due to the changeable back positions. A slender strip of illuminating LED lights gives Elements a floating impression. Subdued colours are combined with the durability of Quarry®, developed by Villeroy & Boch. Elements was awarded a Red Dot Award in 2014.











# Air

Designed by Koen Van Extergem

Air is a modular outdoor seating and table collection in wood or aluminum. The sofa's large, voluptuous cushions give a distinctive exotic elegance to every exterior. Fit for any style, the Air table collection comes in a classic design that radiates charm and warmth. Air breathes a fresh breeze into every outdoor moment.









# Zendo

Designed by Stephane De Winter

The Zendo lounge collection elevates relaxation to a whole new level. A spacious lounge or a comfy sofa corner? The classic design of the upholstery sofa concept matches any exterior space. Refinement and meticulous finishing, reflected in the subtle tone-on-tone stitching, is where this collection really shines. The choice of materials allows for durable, weatherproof pieces that still feature luxurious appeal. Experience pure delight as you catch up with friends and loved ones.











# Liner<sup>i</sup>

Designed by Bram Bollen

Thanks to its powder-coated aluminium frame, Liner is a winning lightweight. Whether placed on a terrace or in a lounge or spa, these highly functional chairs and loungers stand out because of their timeless design. The contemporary collection showcases the elegant muted colours of the fabrics with topstitching in matching shades. Liner pieces are available in several complementary designs.







# Loop'

Designed by Gerd Couckhuyt

Flexibility at its best: outside or inside, with or without armrests. The Loop chair collection with powder-coated frames is both lively and elegant. The organic shapes of the collection constitute an expression of fantasy and beauty, ensuring a welcoming ambiance in any imaginable space.











# Moon Island

Designed by Gerd Couckhuyt

Moon Island consists of four sofa islands that can be mixed and moved around a central coffee table or footrest. The minimalist design gives your imagination free rein: possibilities range from an intimate sofa corner to an accommodating lounge island. The Moon Island collection comes in a wide variety of fabrics and colours.









# San

Designed by Lionel Doyen

The San collection draws from Japanese art as inspiration for its truly iconic design. Both timeless and contemporary, the minimalist frame has been meticulously refined to expose every detail. An artful blend of shapes and materials illustrates the ingenuity of this creation. The winner of the Interior Design's Best of Year Award in the category 'Furniture - Outdoor Seating', San is a perfect fit for any setting, exterior or interior.

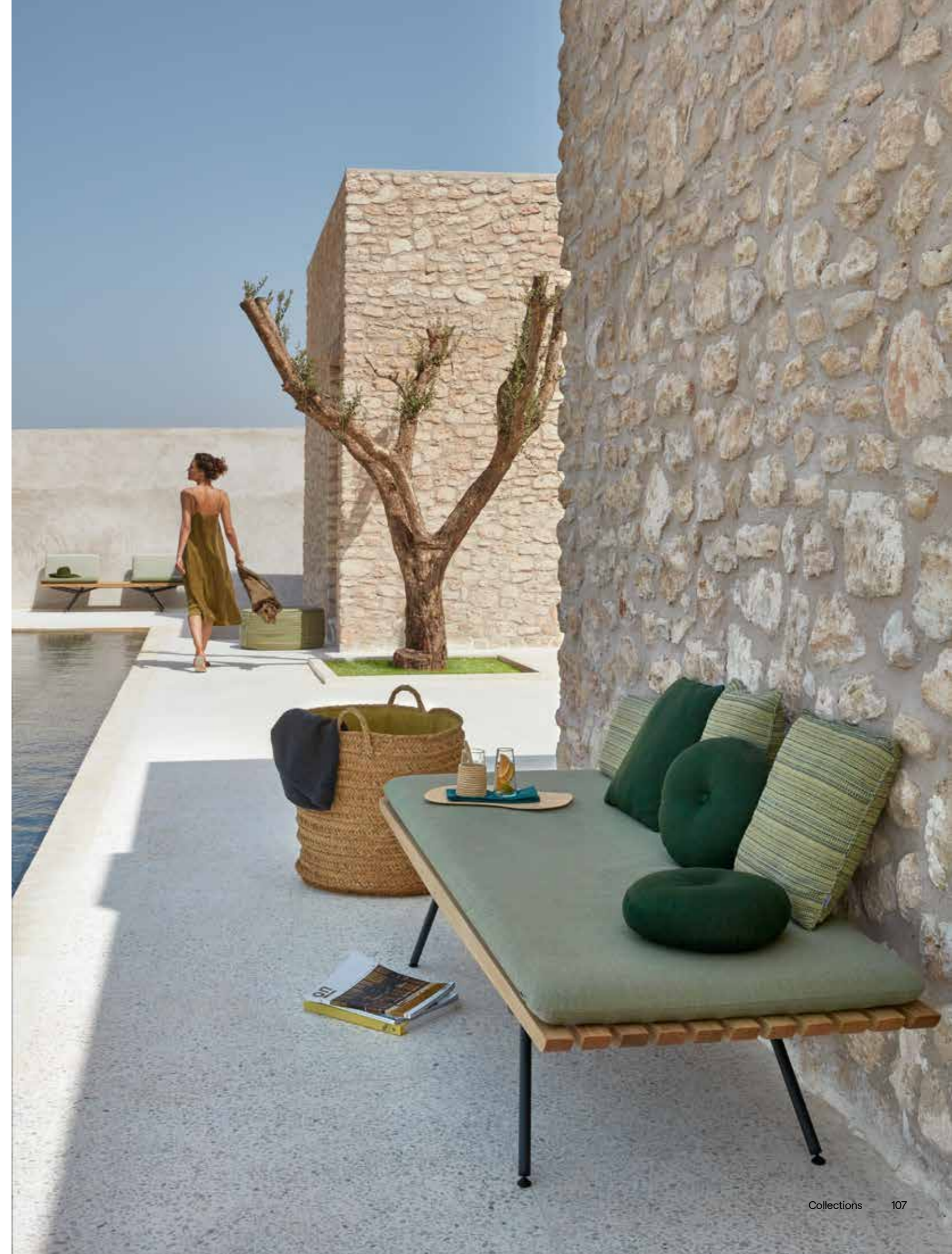







# Siena

Designed by Stephane De Winter

A stylish fusion of delightful architectural lines and the warm charm of resilient wood, that's how the Siena collection can best be described. The solid teak wooden frame braves any weather conditions, hot or cold, wet or dry. For a lounge experience beyond your wildest dreams, Siena is guaranteed to please. In the cooling shade or under a radiant sun, lie back and surrender to its sweet embrace.











# Cross'

Designed by Mads Odgård

Iconic and multidisciplinary, the director's chair makes for a reliable friend in any home, a loyal companion on the beach or boat deck. Inspired by the classic filmset piece, the Cross chair owes its elegance to its inconspicuous, adaptable style. Wherever you are seated, whether on your home balcony or in the hot Kenyan savannah, Cross exudes a timeless presence.















# River

Designed by Stephane De Winter

The River collection owes its name and inspiration to the meandering flow of a watercourse. Through its elegant curves and shapes, the sofas and sunbeds mimic natural surroundings, fostering a harmonious, relaxing space for connection. Become one with nature and experience its calming effects in this low-to-the-ground design with extra deep seating.











# Mood

Designed by Gerd Couckhuyt

Mood is a lightweight and durable resin wicker chair. Designed with translucence in mind, the chairs are available as high or low units. This collection also includes side tables in different sizes and finishes.









# San Diego

Designed by Stephane De Winter

The San Diego collection combines strong water-repellent fabrics and synthetic aged rattan cane work. The natural materials and tones add to its ageless appeal.











# Malibu

Designed by Stephane De Winter

The exotic Malibu collection will be your favourite place to relax beneath the palm trees. Whether on the strand or the veranda, the graceful Malibu patio chair exudes sunny sophistication. Perfect to relax in with a delicious cup of tea.











# Latona'

Designed by Stephane De Winter

The sleek and slender lines of Latona complete any modern-day space, large or small. The collection oozes dignity through its cool materials, rigid contours and matching muted colour palette. With its intimate edging, the airy Latona look inspires ultimate serenity.





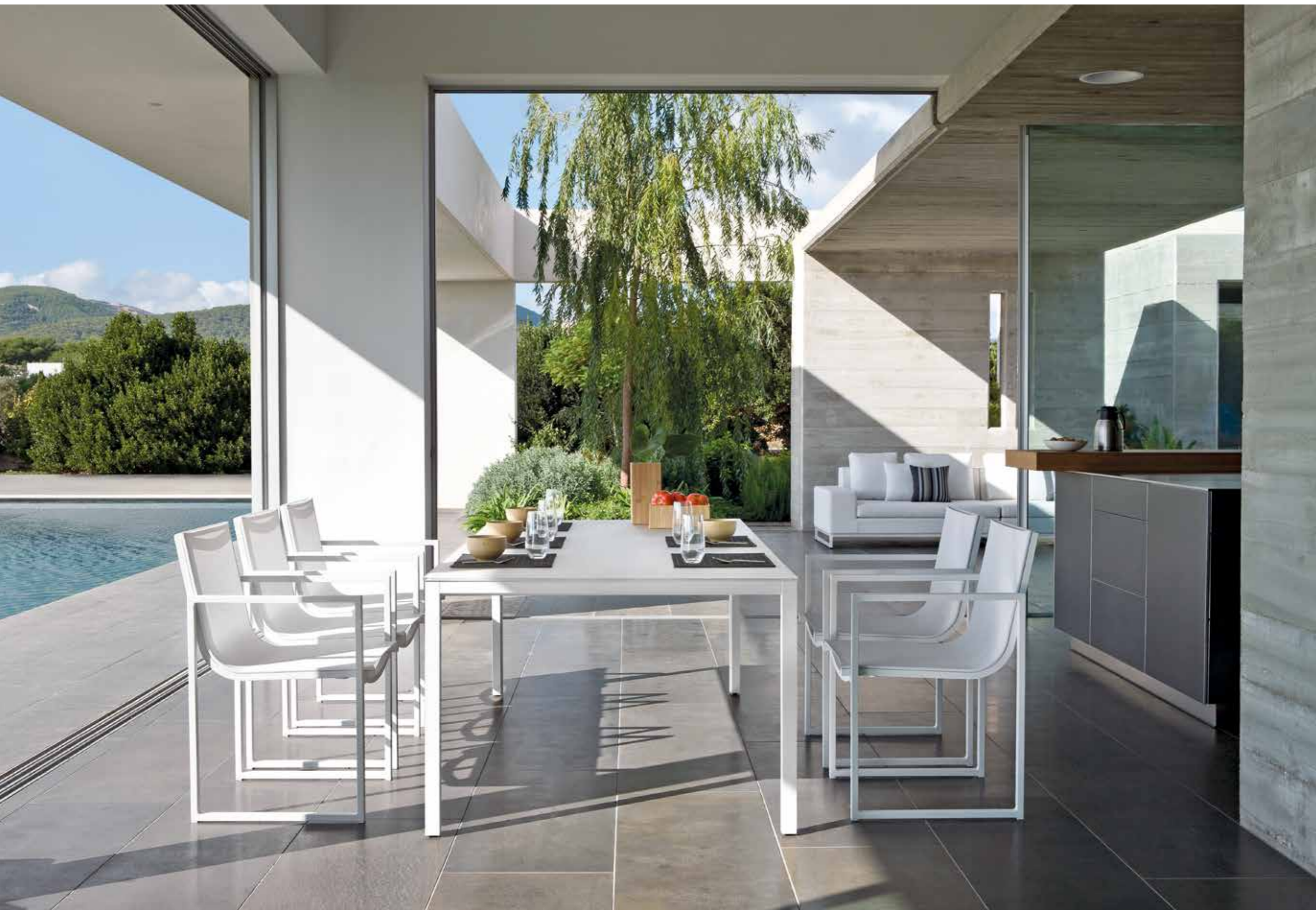



# Fuse'

Designed by Stephane De Winter

Clean-cut lines and a sophisticated appeal are at the heart of the Fuse seating and table collection. The pieces breathe a warm and classic ambience that aligns with any rustic environment. The minimalist and ultra-light design of the collection create a sense of pure delight.













# Luna

Designed by Stephane De Winter

The stately extendable Luna table opens the door to endless combinations. Thanks to its clean lines, any seat combines with the modest design of this piece. Add a backlit LED base and treat your guests to an atmospheric vibe.







# Trento'

Designed by Stephane De Winter

The Trento table collection combines elegant design with unprecedented ease of use due to its built-in wheels. The seemingly floating tabletop gives every piece in the collection a modern, graceful look.







# Quarto'

Designed by Stephane De Winter

Notable for its light design, Quarto tables draw strength from simplicity. This collection is fit for any setting and occasion, due to its understated style and variety of finishes.



# Livorno

Designed by Stephane De Winter

A solid wooden frame makes for a natural, rustic look. The Livorno table collection offers a variety of dining, high dining and coffee tables and the ability to combine them with any chair you like.







# Milano'

Designed by Stephane De Winter

Sit at the drawing board and dream up your perfect outdoor table. We offer a collection of beautiful classic dining, high dining and coffee tables tailored to your wishes.







# Napoli

Designed by Stephane De Winter

Set your imagination free and create an outdoor table that is completely you. We offer a collection of beautiful dining, high dining and coffee tables.





# Side tables'

**Closed outdoor tables**



**Open outdoor tables**







### Vitral outdoor tables







## Round outdoor tables







# Craft & Technology





## The luxury of craftsmanship

At Manutti, we believe that both innovation and artisanal skill are needed to design truly groundbreaking luxury outdoor furniture solutions. Our products harmoniously combine traditional craftsmanship with new technologies and are inspired by the warmth and colour of their natural surroundings. While each piece is distinctive, they all share timeless appeal that invites people to spend any time of the day outside in luxury, bathing in light and surrounded by an authentic ambience.

## Connecting high-tech with tradition

Our experienced artisans manually refine and treat the carefully selected materials of our pieces using pioneering techniques. Carefully executed finishings give our black teak elements their eye-catching alternation between glossy and matte textures, and all rope seating elements are woven by hand. Thanks to our ceaseless attention to detail, each piece of furniture radiates just the right amount of elegance, drama and power.







## A marvel of technical complexity

Each creation is tailored to the customer experience. Our thorough research, open mindedness and insatiable creative curiosity encourage us to constantly seek the latest developments in technology and design. Manutti is a frontrunner in the use of imitation leather upholstery and finishing with fine stitching in complementary colours. We collaborate with top external designers, craftspeople and suppliers who offer superior quality. This is how Manutti has made its mark as a true trendsetter known for shaping the market for exclusive outdoor furniture.



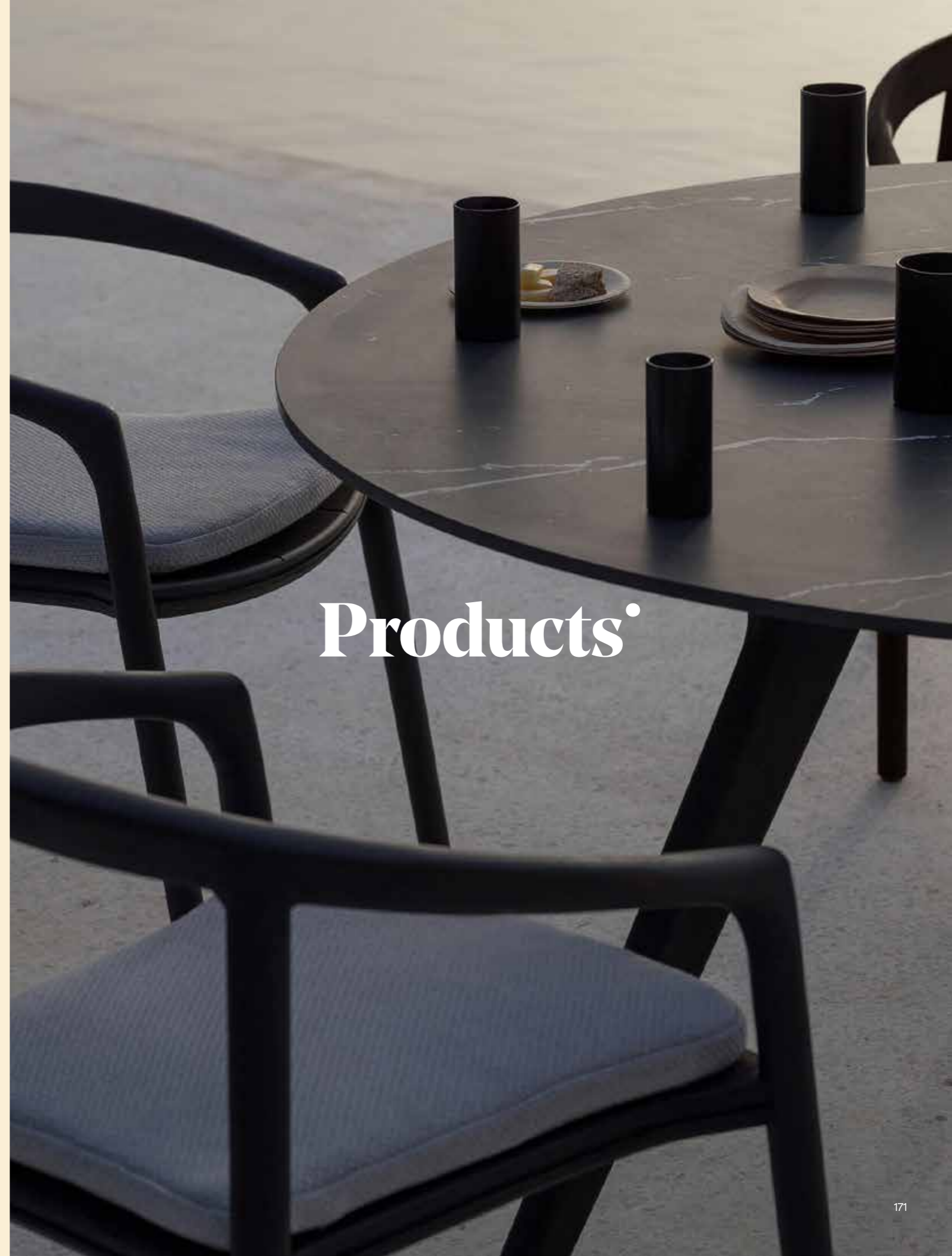

# Products'



# Chairs



## Solid

Available colours  
 Insp. p. 38  
 Tech. p. 200



## Radius

Available colour combinations  
 Insp. p. 52  
 Tech. p. 205



## Echo

Available colour combinations  
 Insp. p. 68  
 Tech. p. 212



## Siena

Available colour combinations  
 Insp. p. 110  
 Tech. p. 237



## Cross

Available colour combinations  
 Insp. p. 114  
 Tech. p. 240



## Cross Teak

Available colour combinations  
 Insp. p. 114  
 Tech. p. 240

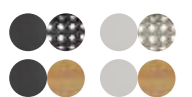

## Duo

Available colour combinations  
 Insp. p. 72  
 Tech. p. 213



## Zendo

Available colour combinations  
 Insp. p. 90  
 Tech. p. 226



## Liner

Available colour combinations  
 Insp. p. 94  
 Tech. p. 229



## River

Available colour  
 Insp. p. 120  
 Tech. p. 242



## Mood

Available colour combinations  
 Insp. p. 124  
 Tech. p. 244



## San Diego

Available colour  
 Insp. p. 128  
 Tech. p. 246



## Loop

Available colour combinations  
 Insp. p. 98  
 Tech. p. 231



## Malibu

Available colour  
 Insp. p. 132  
 Tech. p. 249



## Latona

Available colour combinations  
 Insp. p. 136  
 Tech. p. 251



# Bar stools & stools



## Solid

Available colours



Insp. p. 38  
Tech. p. 196



## Radius

Available colour combinations



Insp. p. 52  
Tech. p. 205



## Mood

Available colour combinations



Insp. p. 124  
Tech. p. 244



## Latona

Available colour combinations



Insp. p. 136  
Tech. p. 251

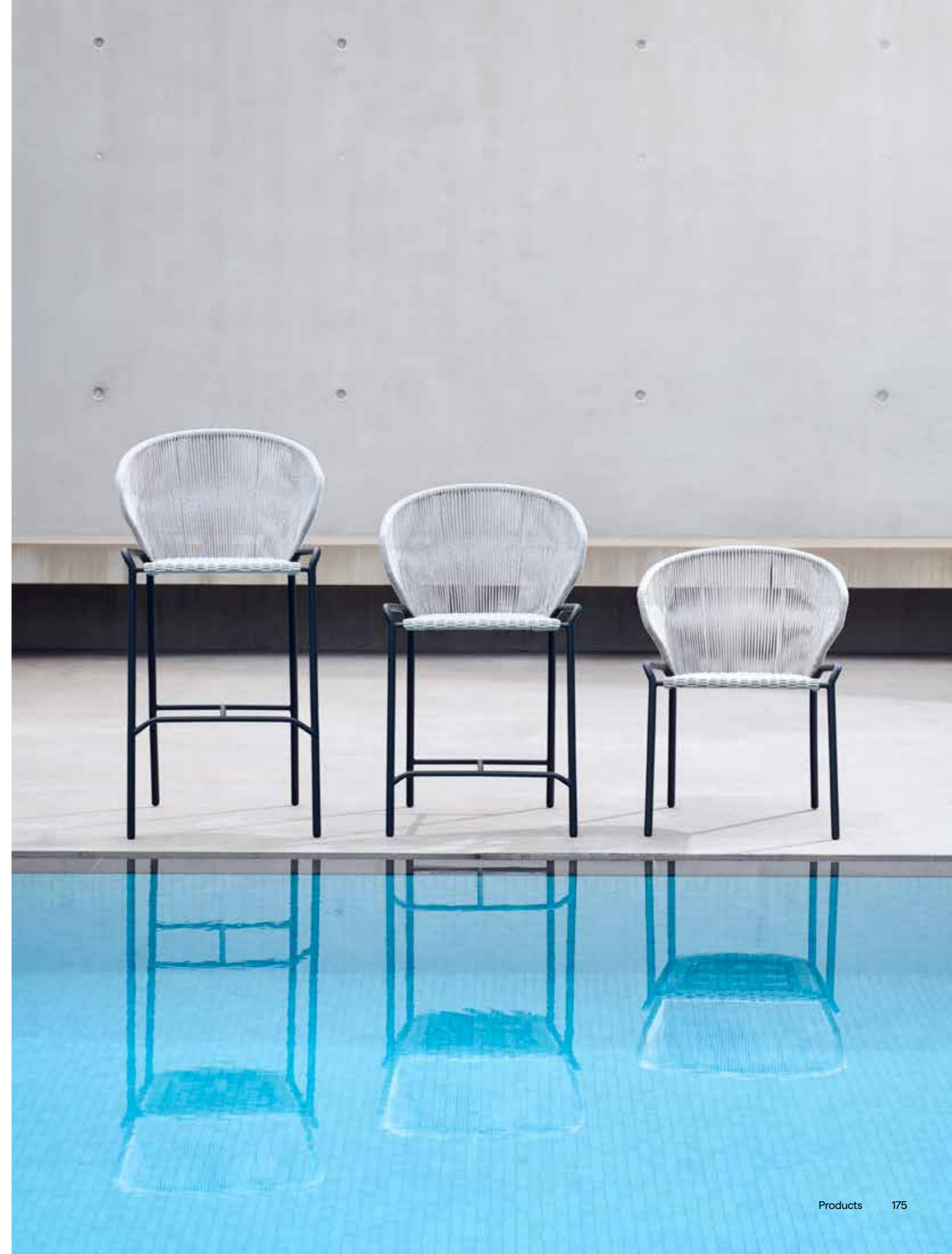



# Lounge chairs



## Flex°

Available colour combinations  
 Insp. p. 30  
 Tech. p. 196



## Kobo°

Available colours  
 Insp. p. 48  
 Tech. p. 204



## Radius°

Available colour combinations  
 Insp. p. 52  
 Tech. p. 205



## San Diego°

Available colour  
 Insp. p. 128  
 Tech. p. 246



## Malibu°

Available colour  
 Insp. p. 132  
 Tech. p. 249



## Fuse°

Available colour combinations  
 Insp. p. 140  
 Tech. p. 252



## Cascade°

Available colour combinations  
 Insp. p. 62  
 Tech. p. 210



## Echo°

Available colour combinations  
 Insp. p. 68  
 Tech. p. 212



## Zendo°

Available colour combinations  
 Insp. p. 90  
 Tech. p. 226  
 + optional combinations



## Liner°

Available colour combinations  
 Insp. p. 94  
 Tech. p. 229



## River°

Available colour  
 Insp. p. 120  
 Tech. p. 242



## Mood°

Available colour combinations  
 Insp. p. 124  
 Tech. p. 244





# Sofas



## Flex

available colour combinations



Insp. p. 30  
Tech. p. 196



## Kobo

Available colours



Insp. p. 48  
Tech. p. 204



## Air

Available colour combinations



Insp. p. 86  
Tech. p. 222



## Zendo

Available colour combinations



+ optional combinations

Insp. p. 90  
Tech. p. 226



## Radius

Available colour combinations



Insp. p. 52  
Tech. p. 205



## Cascade

Available colour combinations



Insp. p. 62  
Tech. p. 210



## Moon Island

Available colours



Insp. p. 102  
Tech. p. 323



## San

Available colour combination



Insp. p. 106  
Tech. p. 234



## Kumo

Available frame colours



Insp. p. 78  
Tech. p. 216



## Elements

Available colour combinations



Insp. p. 82  
Tech. p. 219



## River

Available colour



Insp. p. 120  
Tech. p. 242



## San Diego

Available colour



Insp. p. 128  
Tech. p. 246



# Sofas



## Malibu

Available colour



Insp. p. 132  
Tech. p. 249



## Fuse

Available colour combinations



Insp. p. 140  
Tech. p. 252

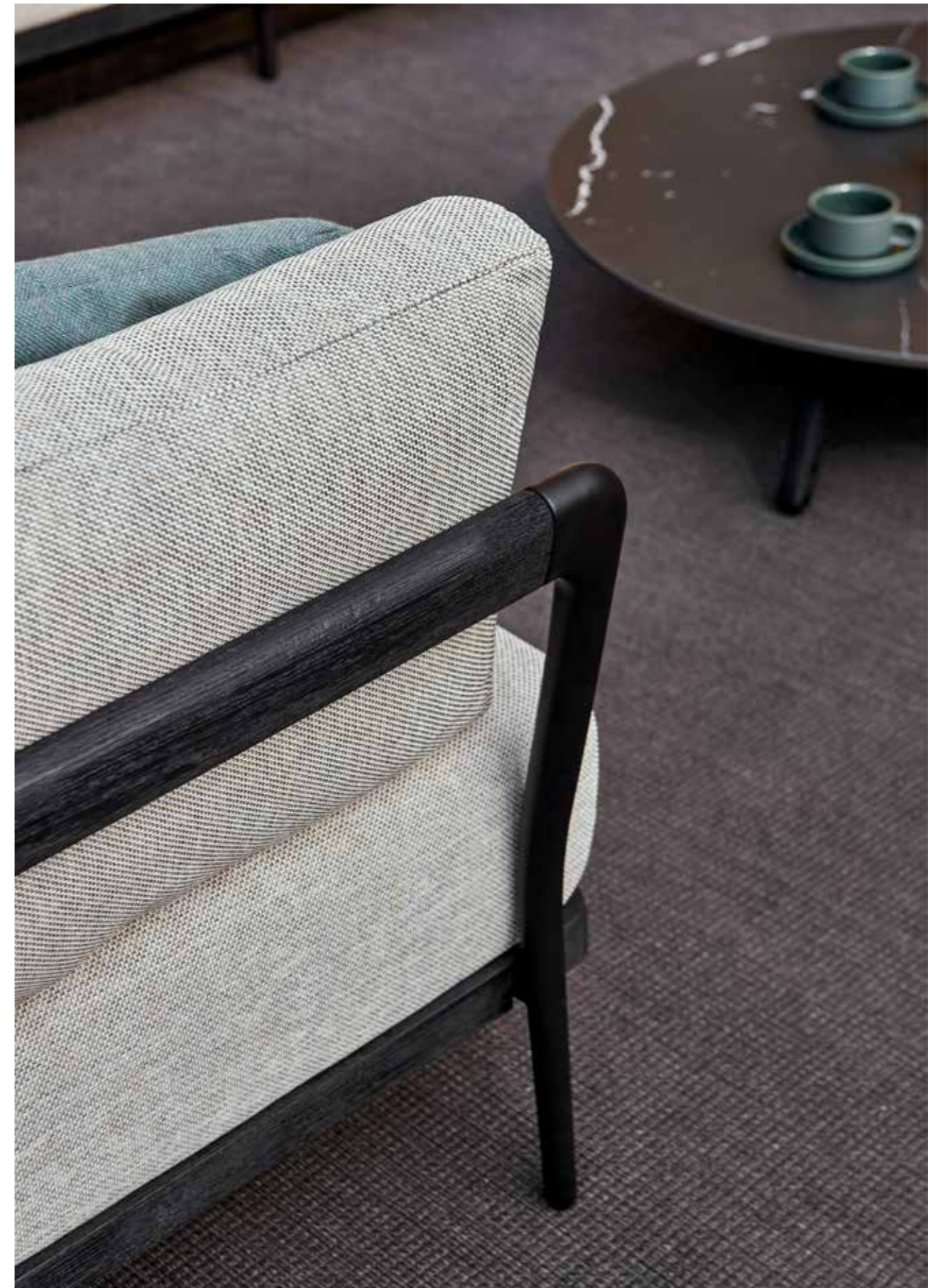



# Loungers



## Radius°

Available frame colours



Insp. p. 52  
Tech. p. 205



## Cascade°

Available colour combinations



Insp. p. 62  
Tech. p. 210



## Kumo°

Available frame colours



Insp. p. 78  
Tech. p. 216



## River°

Available colour



Insp. p. 120  
Tech. p. 242



## San Diego°

Available colour



Insp. p. 128  
Tech. p. 246



## Malibu°

Available colour



Insp. p. 132  
Tech. p. 249



## Elements°

Available colour combination



Insp. p. 82  
Tech. p. 219



## Air°

Available colour combinations



Insp. p. 86  
Tech. p. 222



## Zendo°

Available colour combinations



Insp. p. 90  
Tech. p. 226

+ optional combinations



## Latona°

Available colour combinations



Insp. p. 136  
Tech. p. 251



## Fuse°

Available colour combinations



Insp. p. 140  
Tech. p. 252



## Liner°

Available colour combinations



+ optional combinations

Insp. p. 94  
Tech. p. 229



## San°

Available colour combination



Insp. p. 106  
Tech. p. 234



## Siena°

Available colour combinations



Insp. p. 110  
Tech. p. 237





# Benches



## Prato

Available colour combinations



Insp. p. 76  
Tech. p. 214



## San

Available colour combinations



Insp. p. 106  
Tech. p. 234



## Fuse

Available frame colours



Insp. p. 140  
Tech. p. 252



# Tables



## Flex

Coffee tables  
Available colour combinations



Insp. p. 30  
Tech. p. 196



## Torsa

Coffee tables / dining tables / high dining tables  
Available frame colours



Insp. p. 44  
Tech. p. 201



## Mood

Coffee tables  
Available frame colours



Insp. p. 124  
Tech. p. 244



## Fuse

Dining tables  
Available frame colours



Insp. p. 140  
Tech. p. 252



## Minus

Coffee tables / Dining tables / High dining tables  
Available frame colours



Insp. p. 58  
Tech. p. 208



## Prato

Coffee tables / Dining tables  
Available colour frames



Insp. p. 76  
Tech. p. 214



## Luna

Extendable dining table  
Available frame colours



Insp. p. 146  
Tech. p. 256



## Trento

Coffee tables / Dining tables  
Available frame colours



Insp. p. 148  
Tech. p. 257



## Air

Dining tables  
Available frame colours



Insp. p. 86  
Tech. p. 222



## Siena

Coffee tables / Dining tables  
Available frame colour



Insp. p. 110  
Tech. p. 237



## Quarto

Lounge tables / Coffee tables / dining tables / High dining tables  
Available frame colours



Insp. p. 150  
Tech. p. 258



## Livorno

Dining table  
Available frame colour



Insp. p. 152  
Tech. p. 260



# Tables



## Milano\*

Extendable dining table  
Available frame colour

Insp. p. 154  
Tech. p. 262



## Side tables\*

Available frame colours

Tech. p. 158  
Tech. p. 264



## Napoli\*

Bar tables / Dining tables  
Available frame colours

Tech. p. 156  
Tech. p. 263





# More

## Rugs



### Linear\*

Available colours



Tech. p. 265



### Twist\*

Available colours



Tech. p. 265

## Outdoor lighting



### Flame\*

Available colours



Tech. p. 266



### Trolleys\*

Available colours



### Towel rack\*

Available colour



Tech. p. 267



### Trays\*

Available colours



Tech. p. 267

## Poufs



### Kumo poufs\*

Available in all fabric colours



Tech. p. 269



### Touch poufs\*

Available in all fabric colours



Tech. p. 269



### Moon Island poufs\*

Available in all fabric colours



Tech. p. 269





# More

## Umbrellas



### Central pole\*



Available colours



Tech. p. 270



### Small central pole\*



Available colours



Tech. p. 270

## Cushion boxes



### Powder coated\*

Available colours



Tech. p. 272



### Teak\*

Available colours



Tech. p. 272



### Wicker\*

Available colours



Tech. p. 272





# Technical specifications'



# Flex

Designed by Metrica



## Materials & colours



## Cushions

Suggested colour combo  
(see page 286)

teak/flint:  
sd-vanilla-2

brushed teak nero/black:  
cw-cimento-2  
tc-nebbia-2  
te-vanilla-1

## Features

Modular system

## Options

Protective cover (see page 294)

### 1S / 1S048 - DEEPSEATER

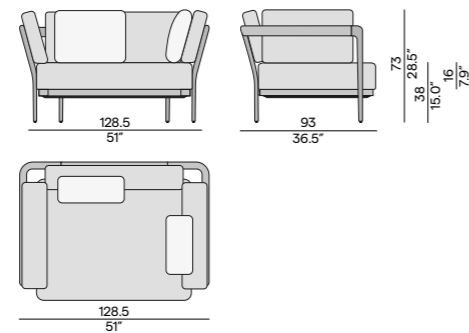

### 2S / 2S100

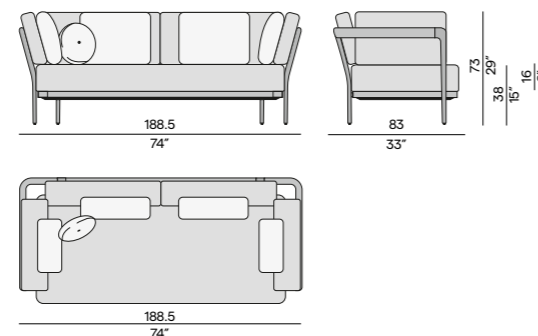

### 3S / 3S001 - DEEPSEATER

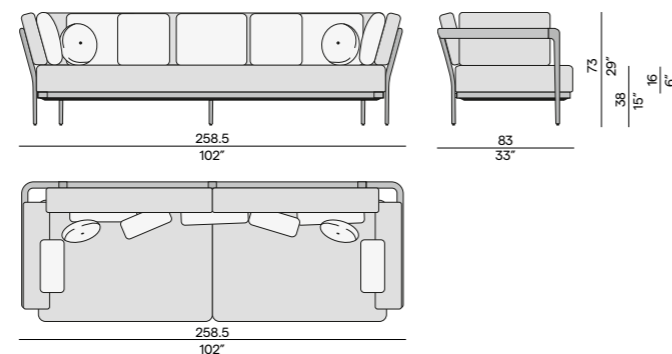

### Large middle seat / MSL001

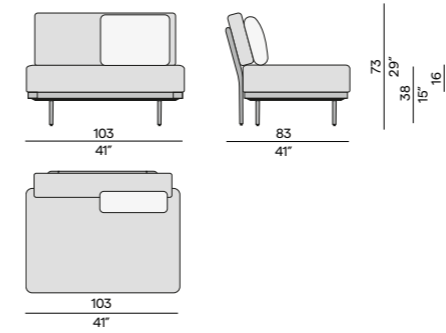

### Left corner double end seat / CDLES001

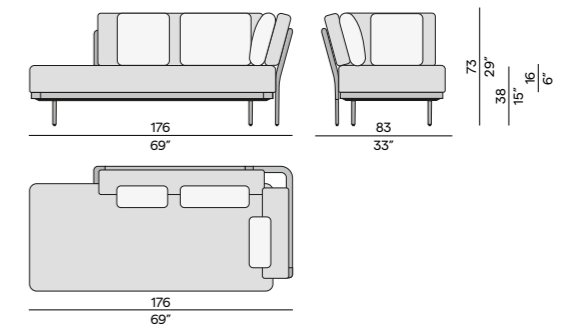

### Right corner double seat / CDRS001

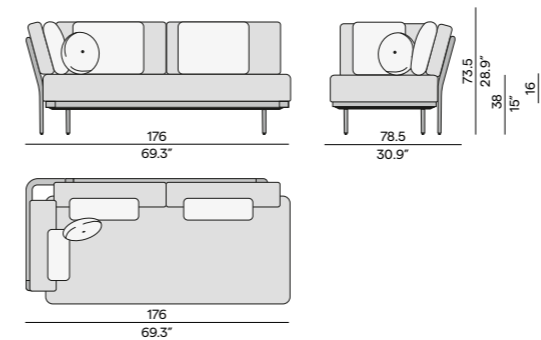

### Corner / CS002

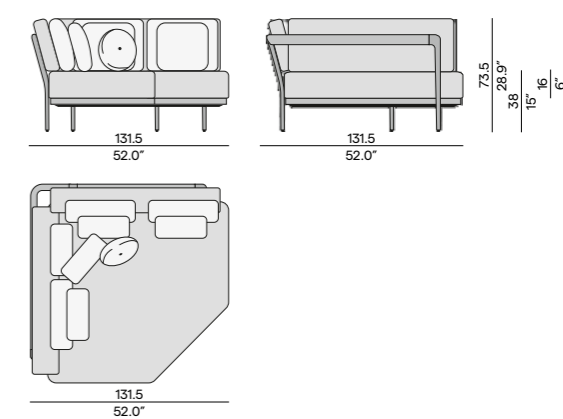

### Left corner double seat / CDLS001

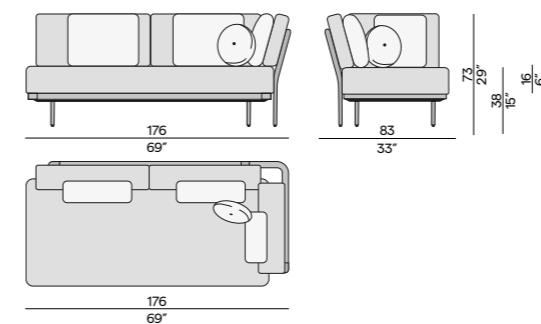

### Large footstool/Loungetable / FLO03

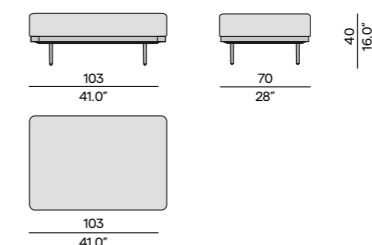

### Right corner double end seat / CDRES001

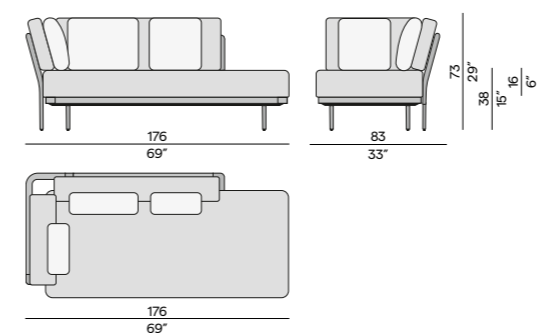



# Flex

Designed by Metrica



Medium floating table / 70x70

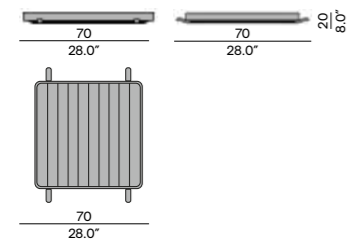

Small floating table / 70x44.5

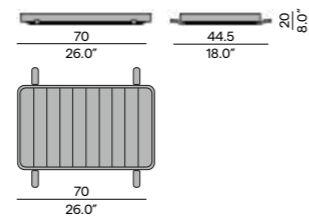

Medium coffee table / 76x70

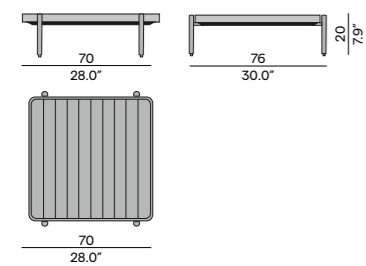

Medium end table / 73x70

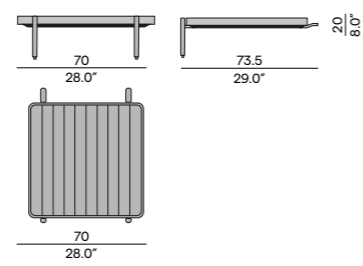

Small end table / 66x47

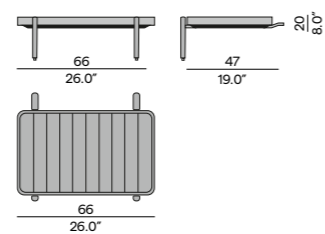



# Solid

Designed by Lionel Doyen



## Materials & colours

### Frame

#### Teak



## Cushions

Suggested colours & fabrics  
(see page 286 & 282)

#### Teak:

dravite  
cottage terra  
smokey

#### Brushed teak nero:

sepia  
nebbia  
cemento

## Features

- Stackable chair
- Removable back cushion

### Armchair / CH41

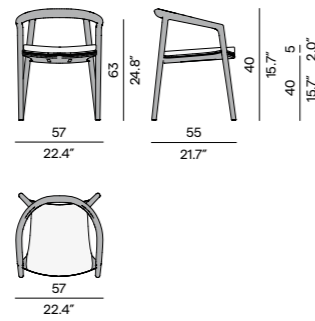

### Barstool / BS073

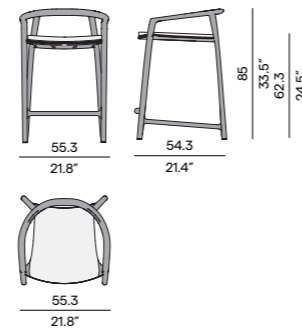

### Stool / BS071

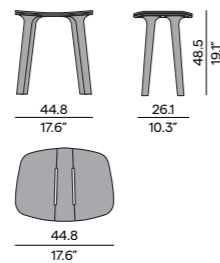

### Counter stool / BS072

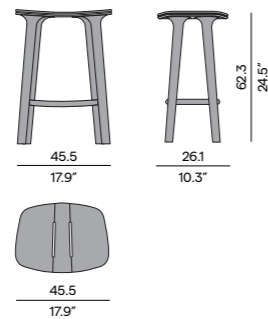

# Torsa

Designed by Stephane De Winter



## Materials & colours

### Frame

#### Teak

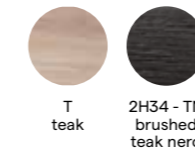

### Table top

CE - ceramic 6mm (only for rectangular table)

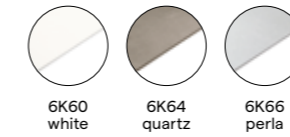

### CE - ceramic 12mm



### Dining table

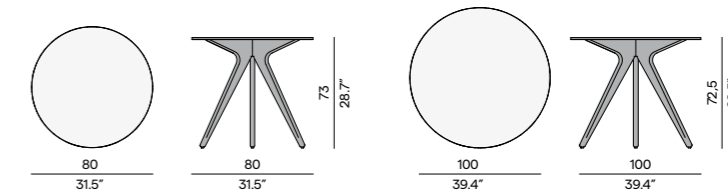
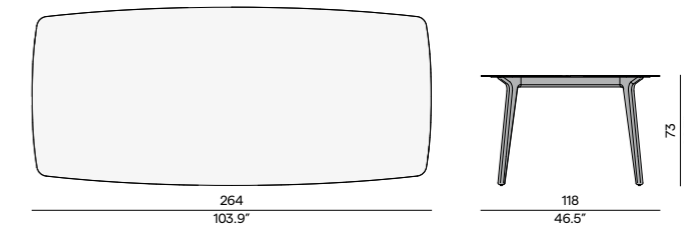
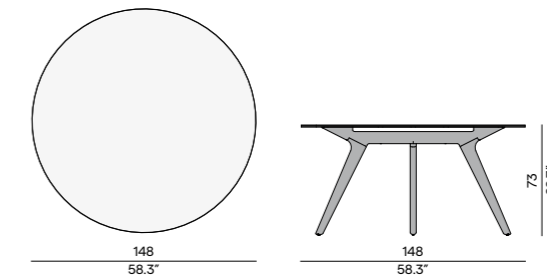

### Coffee table

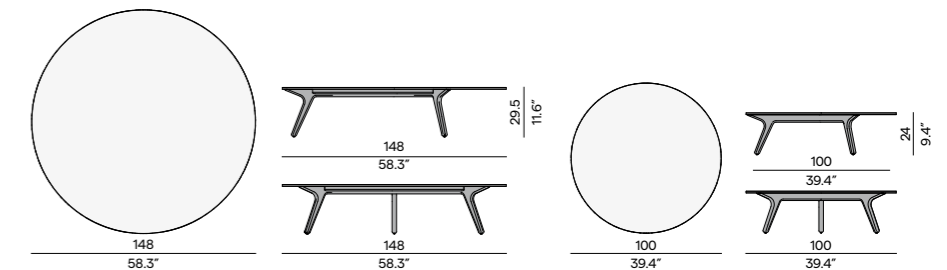

## Features

Oval shaped ceramic table top  
with rounded corners

## Options

Protective cover (see page 294)



# Torsa°

Designed by Stephane De Winter



High dining table / 264 x 118

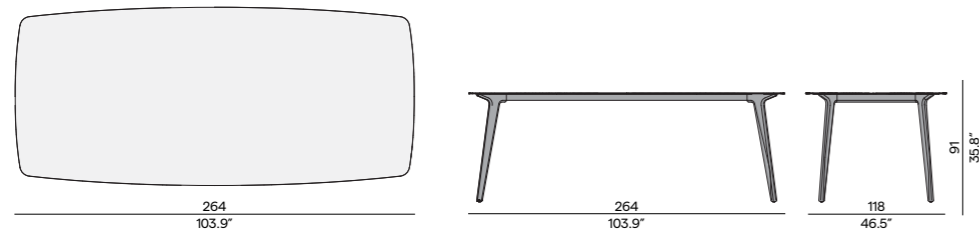

High dining table / Ø148



High dining table / Ø100

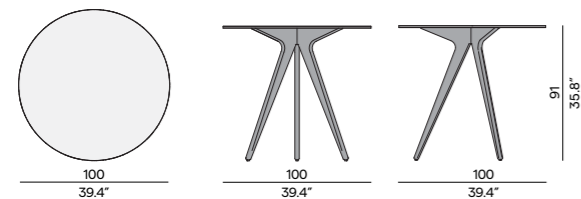

High dining table / Ø80

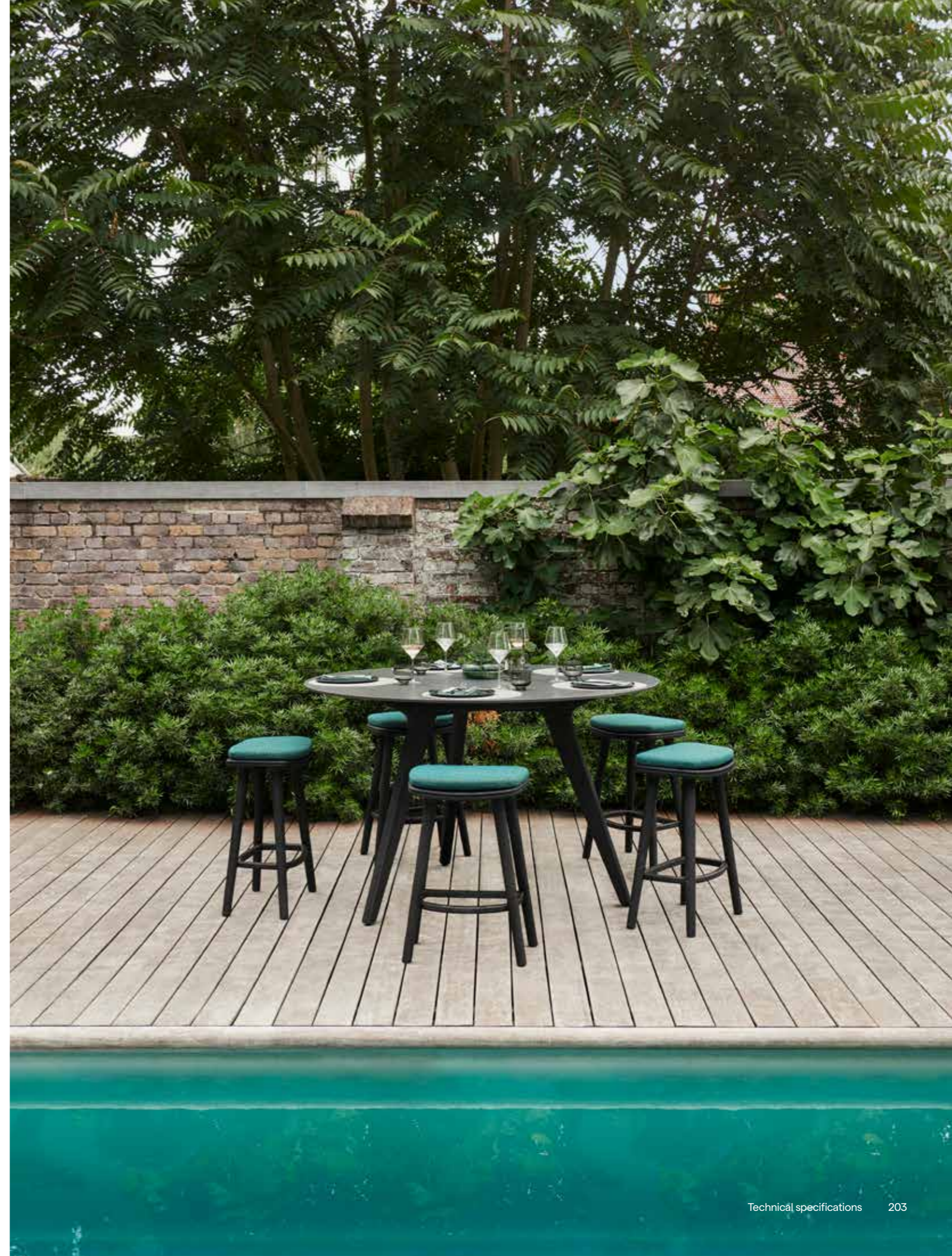
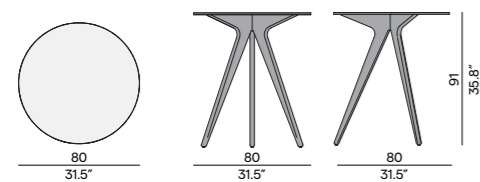



# Kobo

Designed by Stephane De Winter



## Materials & colours

### Finishing

Rope



4R03 anthracite  
4R04 pepper

## Cushions

Suggested colour combo  
(see page 286)

Anthracite:  
te-linen-1  
tc-nebbia-2  
cw-sepia-1

Pepper:  
te-sepia-1  
sd-salty white-1

## Options

Protective cover (see page 294)

### 1S / 1S46

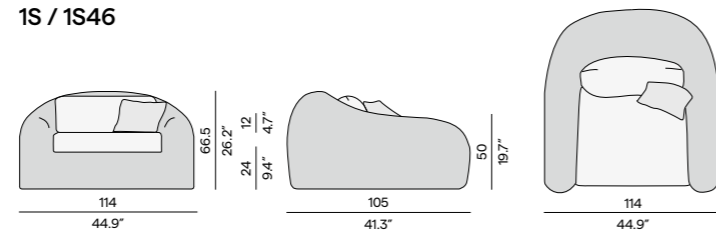

### 3S / 2S94

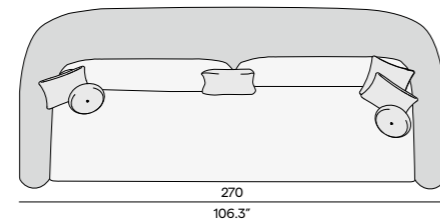
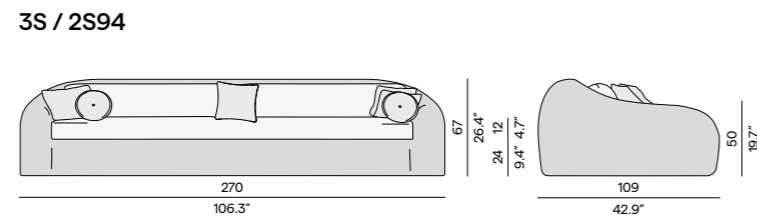

### Lounger / LO57

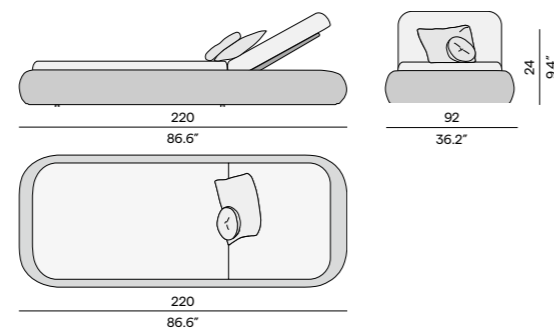

# Radius

Designed by Stephane De Winter



## Materials & colours

### Frame - Finishing

PCSTS - rope

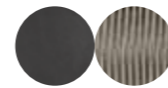

SF10 lava  
1R01 bronze

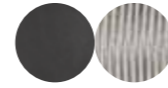

SF10 lava  
1R02 silver



SF13 flint  
1R04 pepper

## Cushions

Suggested colour combo  
(see page 286)

lava/bronze:  
te-vanilla-1  
sd-vanilla-1

lava/silver:  
tc-milestone-1  
cw-metallic-1  
cw-metallic-2  
cw-abyss-1

flint/pepper:  
sd-dune-2  
te-taupegrey-1

## Options

Protective cover (see page 294)

### Chair / CH40

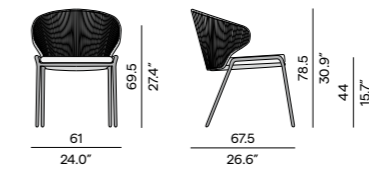

### Barstool / BS69

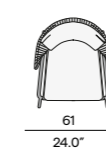
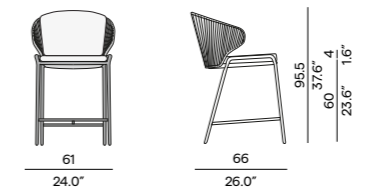

### Barstool / BS70

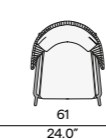
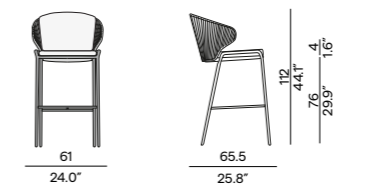





# Radius°

Designed by Stephane De Winter



## 1S / 1S47

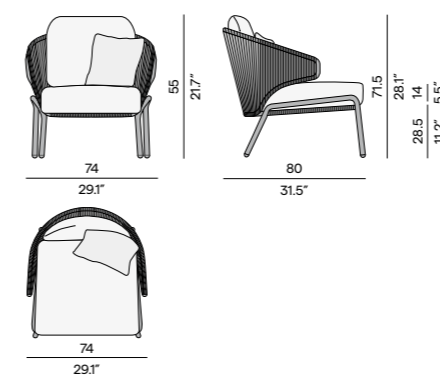

## Chaise Longue / LO58

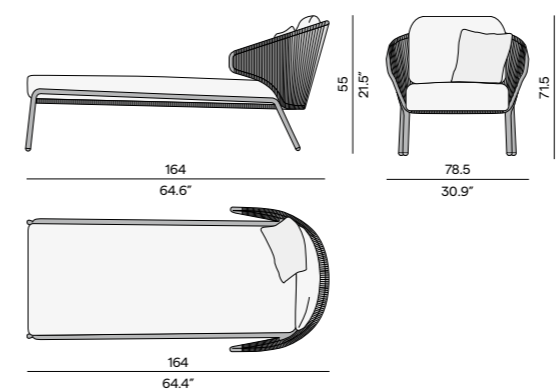

## Medium footstool / sidetable / FR87M

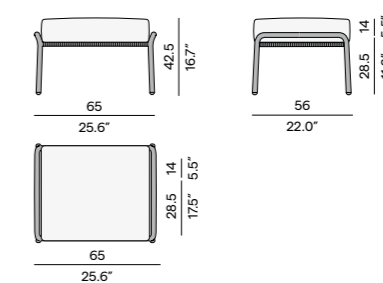

## 2,5S / 2S83

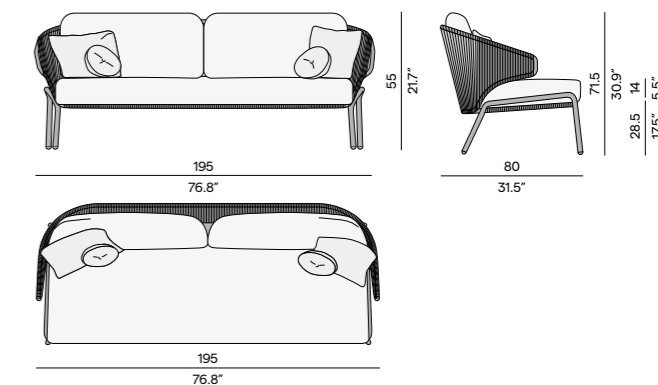

## 3S / 2S84

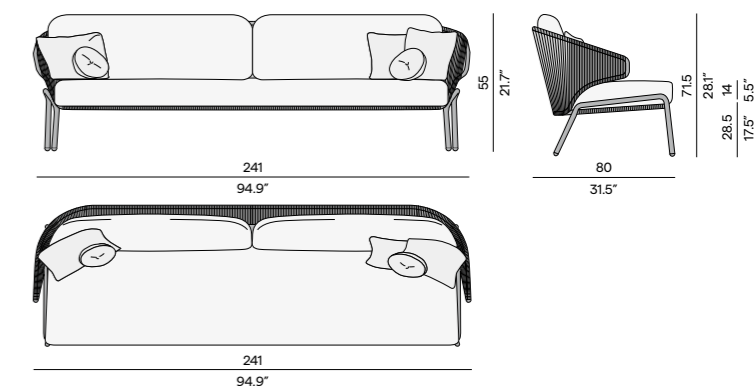



# Minus

Designed by Stephane De Winter



## Materials & colours

### Frame

PCA



AF10  
lava

AF13  
flint

### Table top

CE - ceramic 12mm



5K53  
fossil

5K54  
travertin geo

5K66  
perla

## Features

Table top in 1 piece with  
5 parts simulation

## Options

Protective cover (see page 294)

Dining table / 280x100

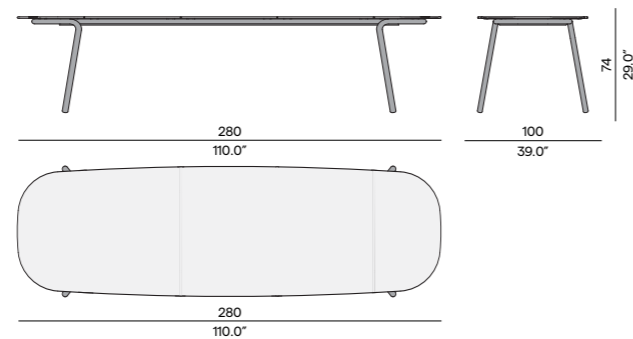

Dining table / 280x85

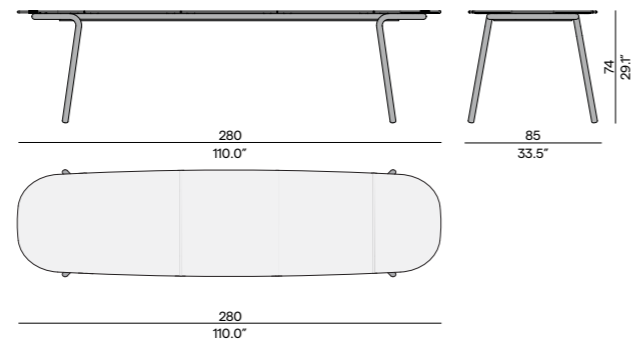

Dining table / 220x100

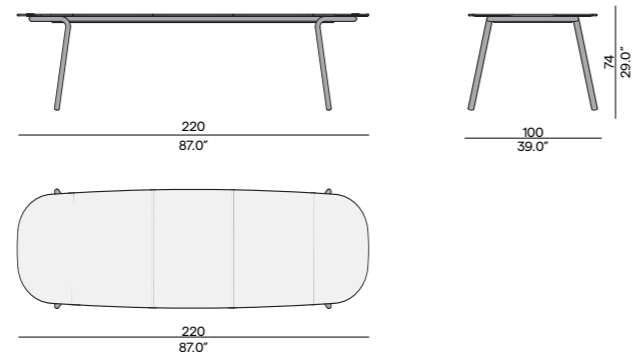

High dining table / 220x100

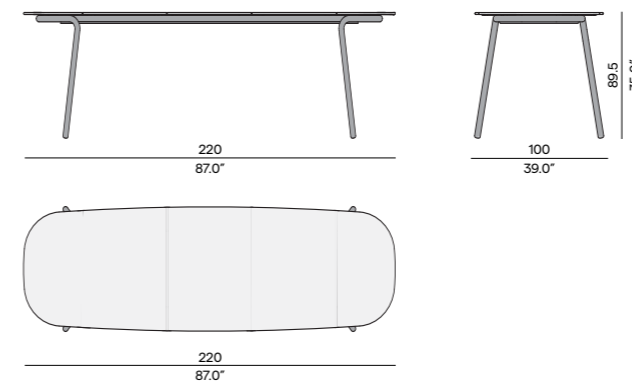

Coffee table / 148x74

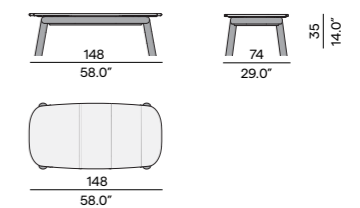



# Cascade°

Designed by Stephane De Winter



## Materials & colours

### Frame - Finishing

PCA - rope



AF08 white  
3R02 silver 45mm



AF10 lava  
3R03 anthracite 45mm

## Cushions

Suggested colour combo  
(see page 286)

white/silver:  
cw-metallic-1  
cw-metallic-2  
cw-vanilla-1

lava/anthracite:  
tc-graphite-1  
te-graphite-1

## Options

Protective cover (see page 294)

### 1S / 1S44

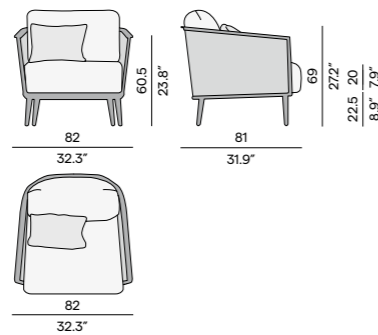

### 3S / 2S90

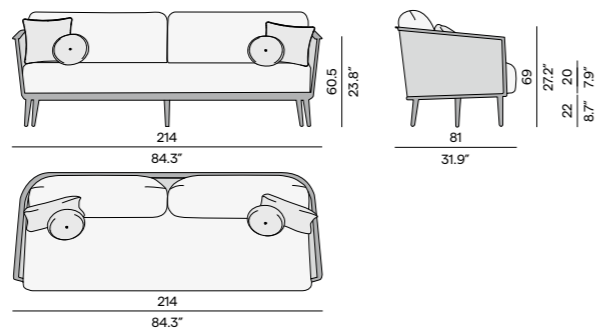

### Daybed / DB01

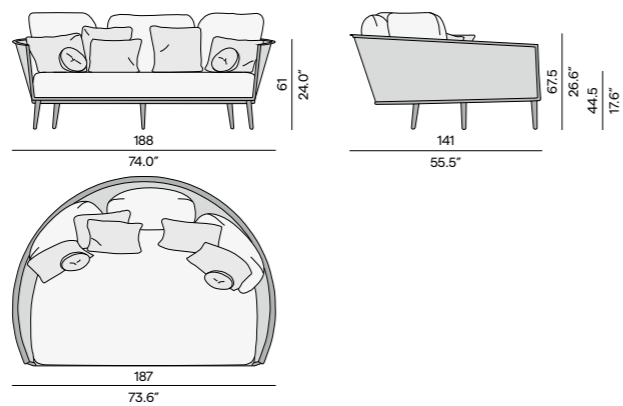



# Echo

Designed by Stephane De Winter



## Materials & colours

### Frame - Finishing

PCA - rope



AF08  
white

2R02  
silver  
11mm

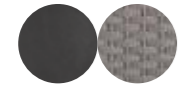

AF10  
lava

2R01  
bronze  
11mm



AF10  
lava

2R03  
anthracite  
11mm

## Features

Stackable chair

## Options

Protective cover (see page 294)

### Chair / CH38

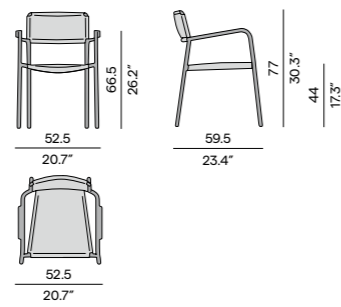

### 1S / 1S43

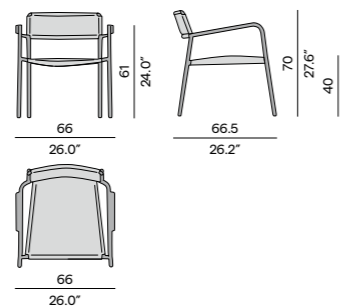

# Duo

Designed by Koen Van Extergem



## Materials & colours

### Frame - Finishing

PCA - rope



AF13  
flint

T  
teak

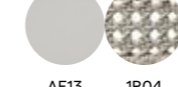

AF13  
flint

1R04  
pepper



AF10  
lava

T  
teak



AF10  
lava

1R03  
anthracite

## Cushions

Suggested colours  
(see page 282)

flint:  
linen  
dune

lava:  
taupe grey

## Features

Stackable chair

## Options

Protective cover (see page 294)

### Chair / CH39

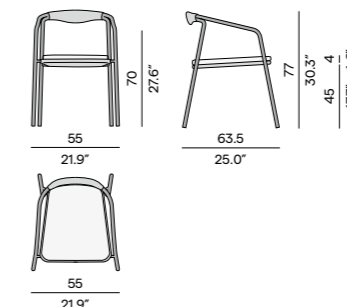

### Rocking chair / RC02

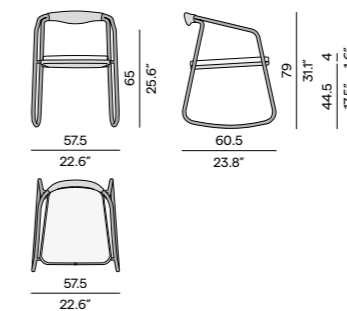



# Prato

Designed by Stephane De Winter



## Materials & colours

### Frame

PWI



WF08 white  
WF10 lava  
WF13 flint  
only for coffee table

### Table top

AT - teak 35mm

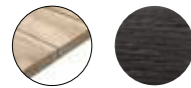

2H33 - AT aged teak  
2H34 - TN brushed teak nero

CE - ceramic 6mm



6K60 white  
6K64 quartz  
6K66 perla

CE - ceramic 12mm



5K53 fossil  
5K54 travertin geo  
5K67 basalt black  
5K58 marble white

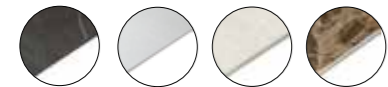

5K59 marble black  
5K66 perla  
5K68 concrete  
5K69 emperador

GL - acid etched glass 10mm

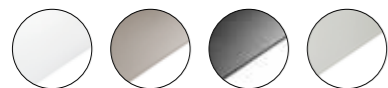

2G70 white  
2G71 taupe  
2G72 black  
2G73 sand

### Dining table



270 / 106.3"  
212.5 / 83.7"

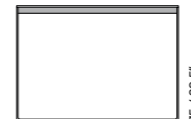

107 / 42.1"

75 / 29.5"

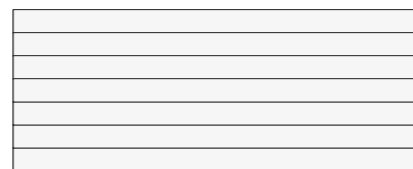

270 / 106.3"

### Coffee table



180 / 70.9"  
150 / 59.1"



90 / 35.4"

35 / 13.8"

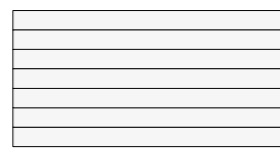

180 / 70.9"

### Bench

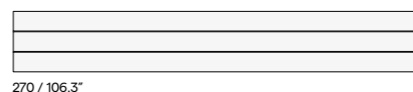

270 / 106.3"



40 / 15.7"

45 / 17.7"





# Kumo<sup>o</sup>

Designed by Lionel Doyen



## Materials & colours

Frame  
PCA



## Cushions

Suggested colour combo  
(see page 286)

white:  
cw-abyss-1  
cw-cimento-2  
cw-metallic-2

lava:  
te-havanna-1  
tc-nebbia-2

flint:  
te-linen-1  
sd-salty white-1

## Features

Modular system

## Options

Protective cover (see page 294)

## Suggested concepts

Concept 1

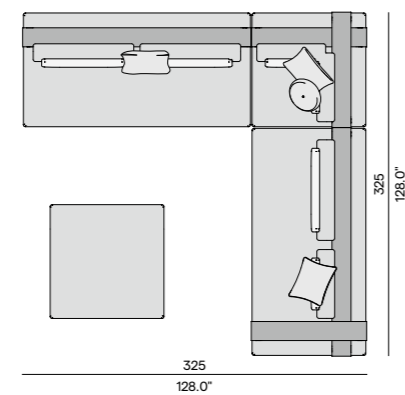

Concept 2

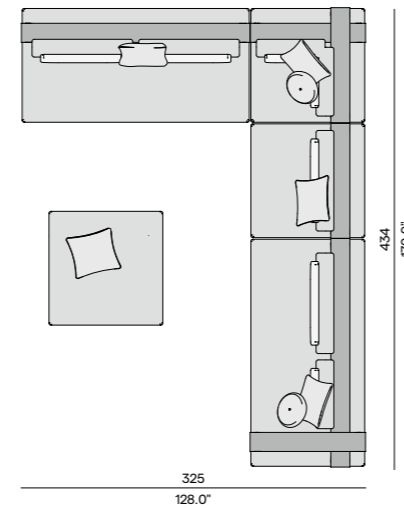

Concept 3

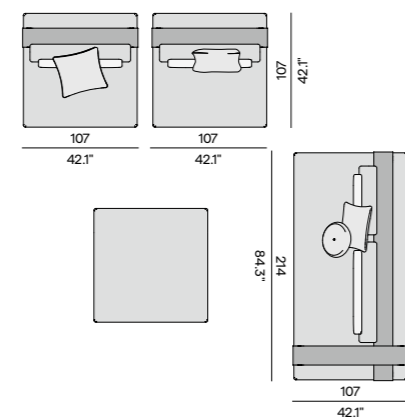

Concept 4

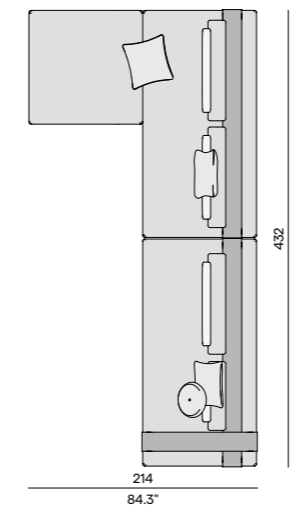

Concept 5

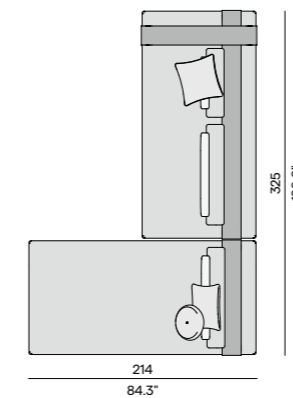

Concept 6

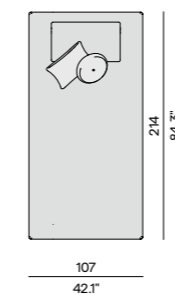

## Available items for customised compositions

Base + Seat 214 / KO214+SC214

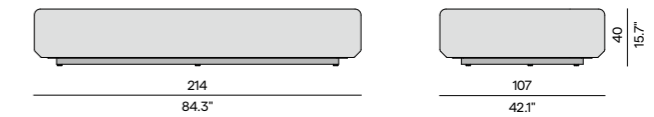

Base + Seat / KO107+SC107

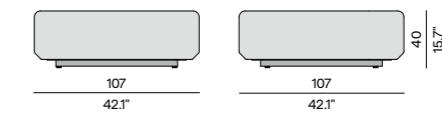

Pouf 50 / KOPF50

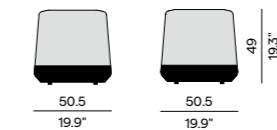

Backrest / BR216x55

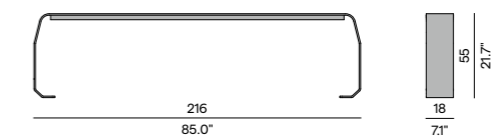

Backrest / BR109x55

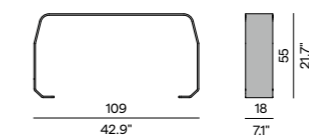

Armrest / AR109x57

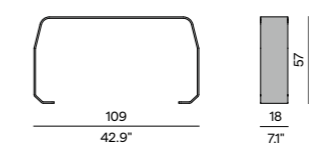







# Elements°

Designed by Gerd Couckhuyt



## Materials & colours

<b>Base</b>	<b>Frame - Top plate</b>
PCA	PCA - Quaryl®
	 
AF07 black	AF08 white Q8-Quaryl® by Villeroy&Boch®

## Cushions

Suggested colour combo  
(see page 286)  
te-havanna-1  
sd-salty white\_1  
cw-abyss-1  
cw-cimento-2  
cw-metalic-2



## Features

- Modular system
- Reclining back 30°

## Options

- Protective cover (see page 294)
- Remote controlled LED-Lighting

## Suggested concepts

### Concept 1

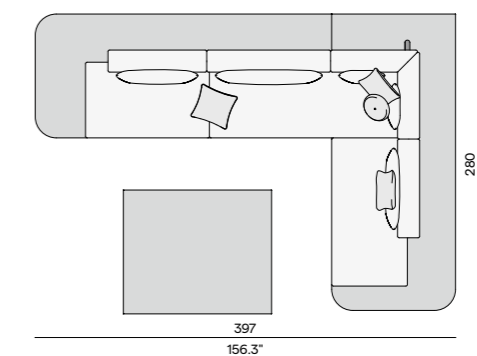

### Concept 2

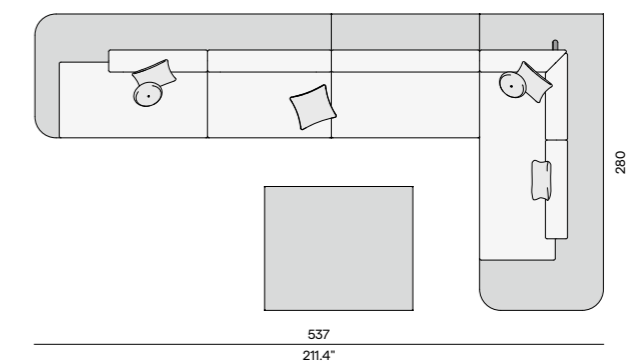



# Elements°

Designed by Gerd Couckhuyt



## Suggested concepts

Concept 3

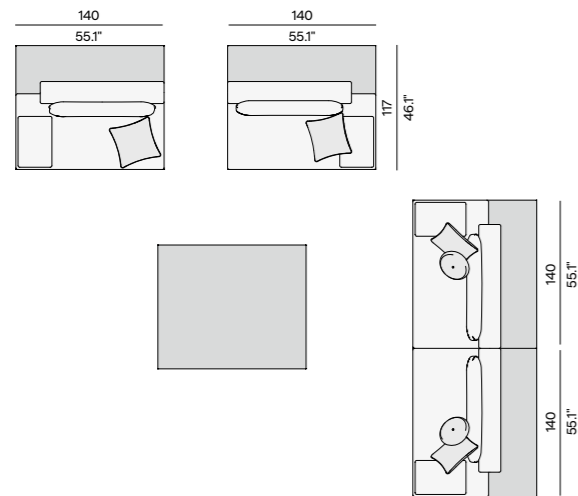

Concept 5

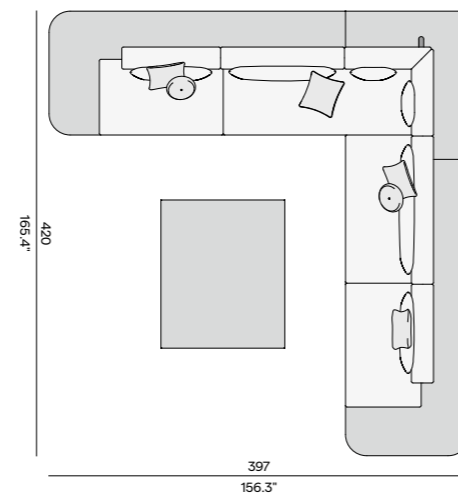

Concept 4

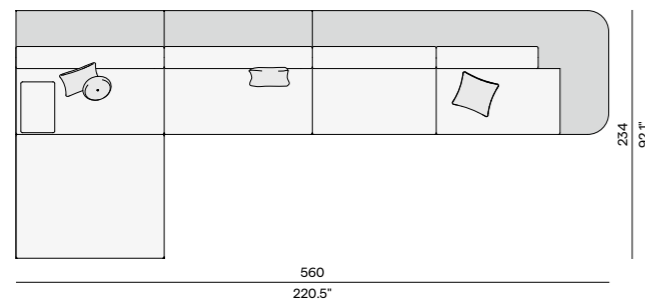

Concept 6

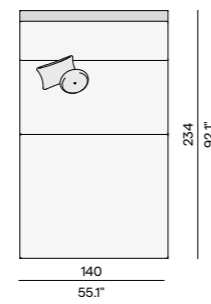

## Available items for customised compositions



Left end seat 280 / ESELS

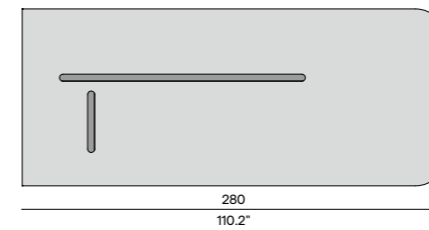

Right end seat 280 / ESERS

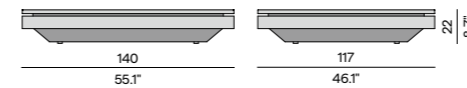
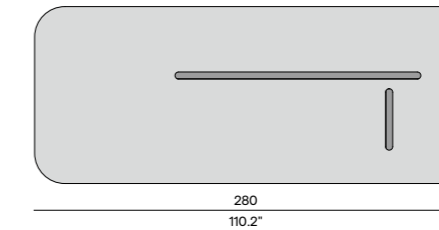

Corner seat 140 / ESCS

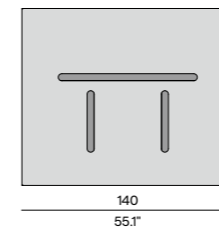

Large middle seat 140 / ESMSL

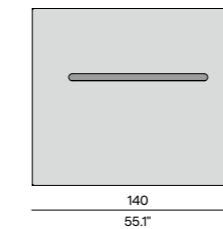

Large footstool / Coffee table 140 / ESFL

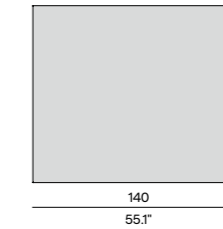

Footrest 70 / ESFR

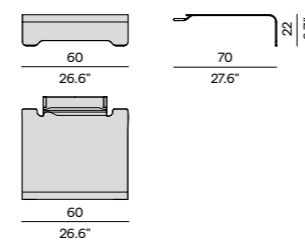

Sidetable 35 / ESST

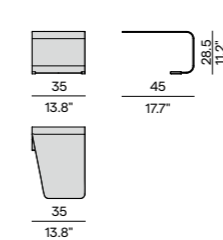

Trolley For Backrests / TY01

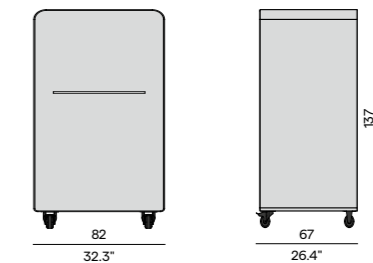



# Air<sup>o</sup>

Designed by Koen Van Extergem



## Materials & colours

### Frame - Finishing

PCSTS - alu



SF10 lava  
AF10 lava

PCSTS - iroko



SF10 lava  
IR iroko



SF08 white  
IR iroko

## Cushions

Suggested colour combo  
(see page 286)

lava/lava:  
tc-nebbia-2  
te-vanilla-1  
te-taupegrey-1

lava/iroko:  
te-linen-1  
sd-vanilla-1

white/iroko:  
cw-cimento-2  
sd-salty white-1

## Features

- Modular system
- Reclining back 30°

## Options

Remote controlled LED-Lighting

## Suggested concepts

### Concept 1

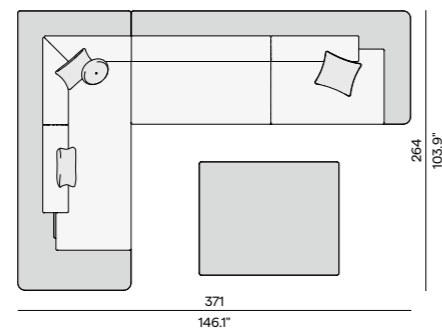

### Concept 2

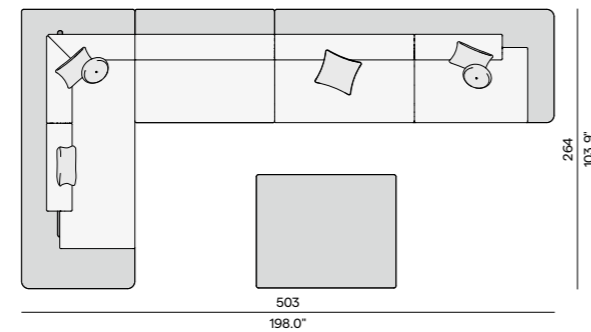

### Concept 3

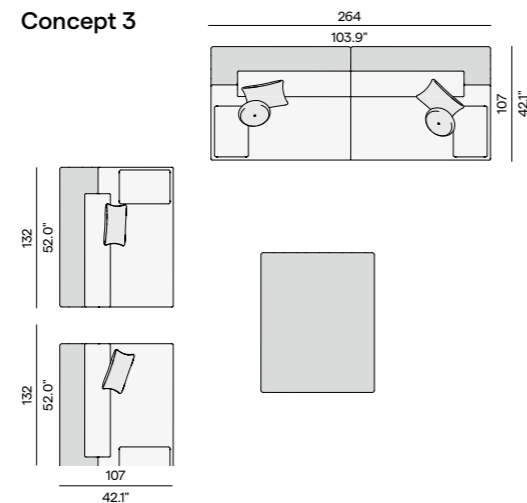

## Suggested concepts

### Concept 4

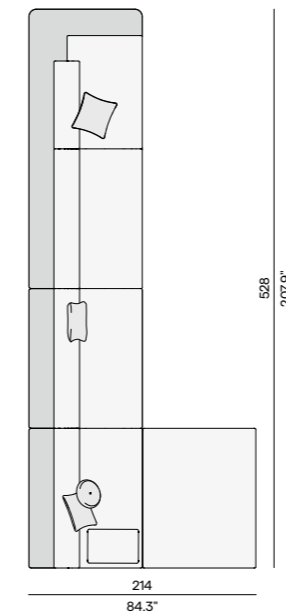

### Concept 5

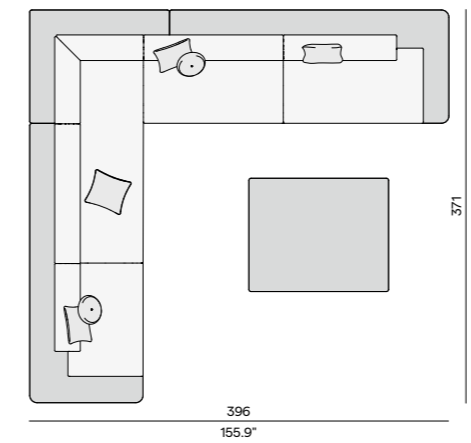

### Concept 6

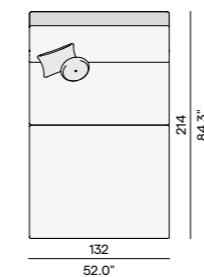

## Available items for customised compositions

### Left end seat / ARELS

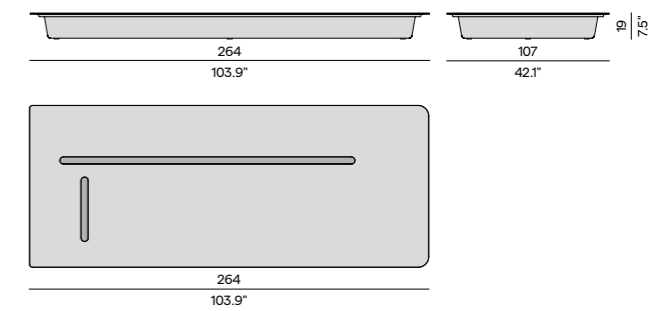

### Right end seat / ARERS

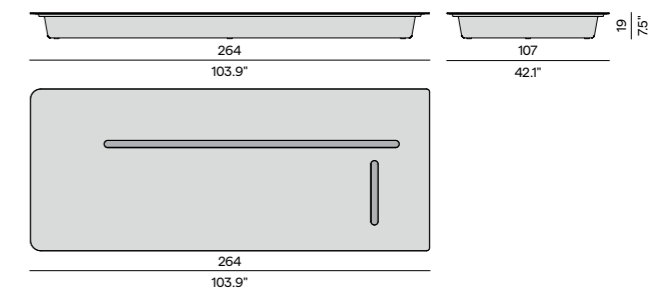

### Corner / ARCS

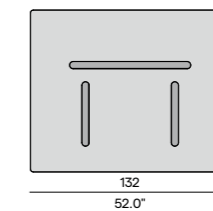

### Large middle seat / ARMSL

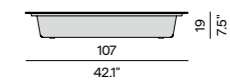
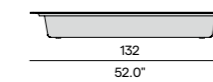
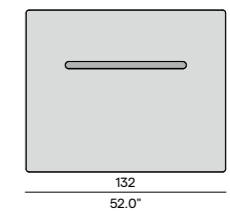

### Large footstool / Coffee table 140 / ESFL

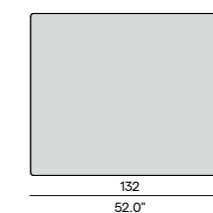

### Trolley / TY02

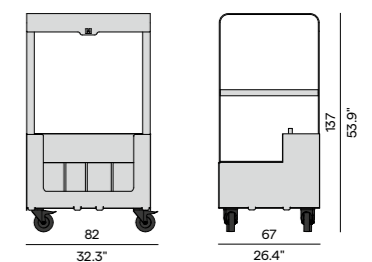



# Air<sup>o</sup>

Designed by Stephane De Winter



## Materials & colours

### Frame

PWI

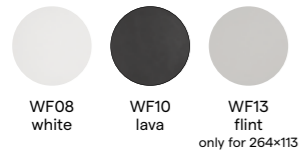

### table top

PCSTS - iroko CE - ceramic 6mm

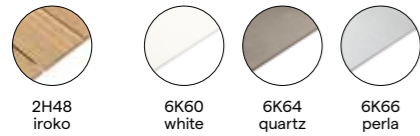

CE - ceramic 12mm

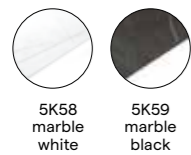
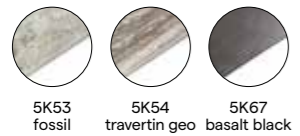

### Dining table

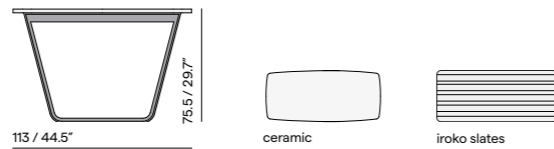
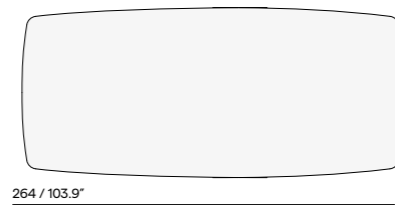
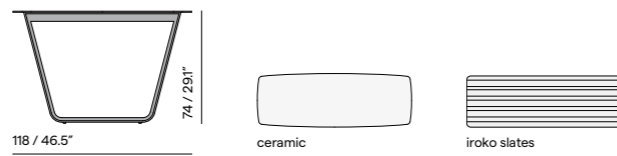
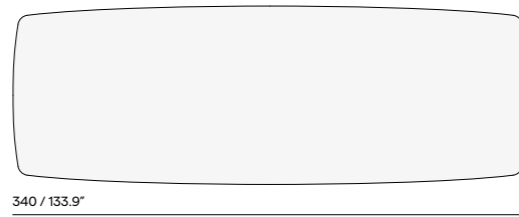

Special saw-cut iroko table top



Oval shaped ceramic table top with rounded corners





# Zendo°

Designed by Stephane De Winter



## Materials & colours

Standard combinations frame - Finishing

PCA - outdoor fabric

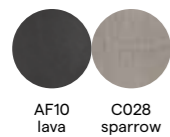
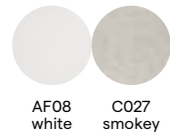

PCA - nautic leather

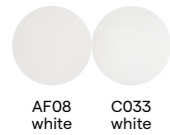

Optional combinations frame - Finishing

Please refer to pricelist

## Cushions

Suggested colour combo  
(see page 286)  
cw-smokey-3  
sd-nautic leather white-1

## Features

- Modular system
- Lounger with wheels

## Options

Protective cover (see page 294)

## Suggested concepts

Concept 1

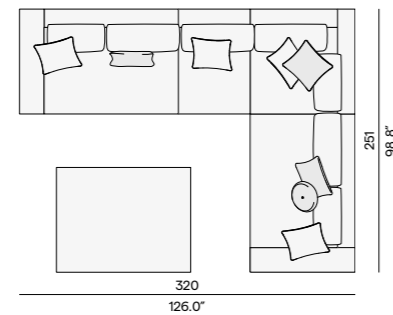

Concept 2

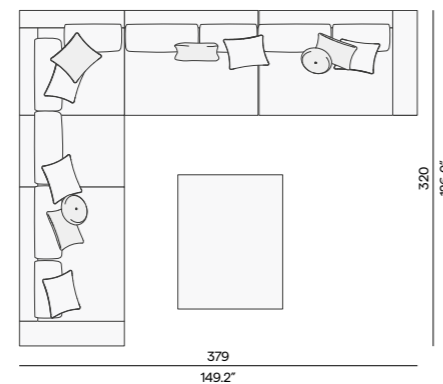

Concept 3

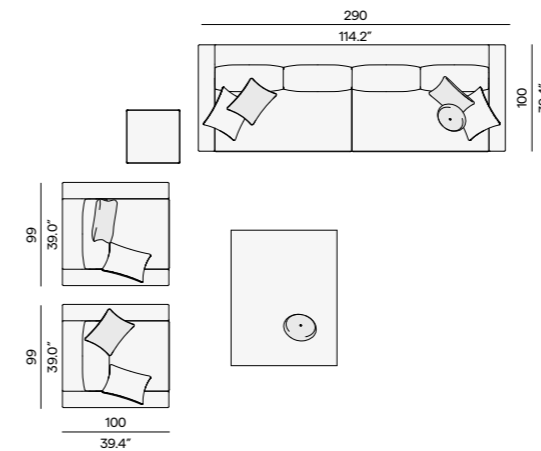

Concept 4

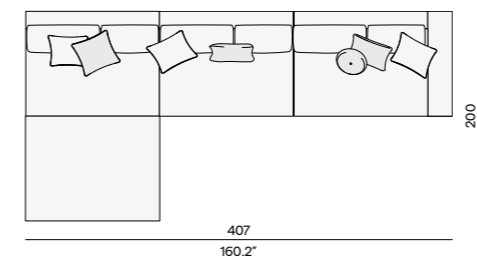

## Available items for customised compositions

Club chair / CH30

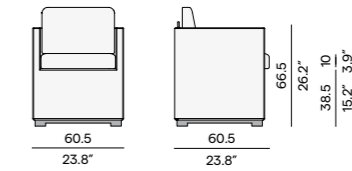

1S / ZO1S

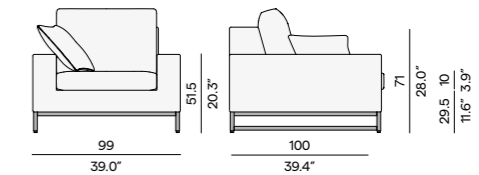

2.5S / ZO2S

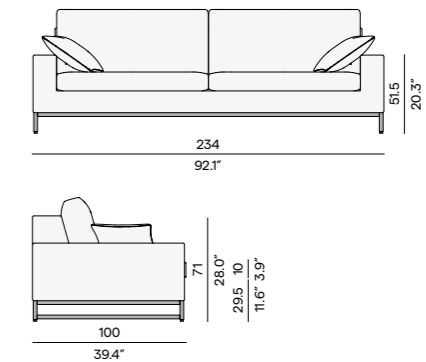

3S / ZO3S

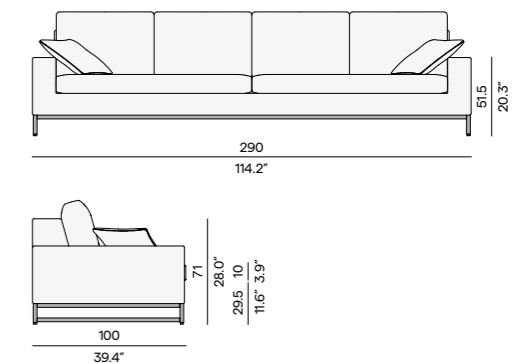



# Zendo

Designed by Stephane De Winter



Left seat / ZOLS

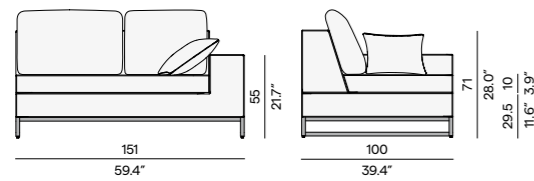

Small middle seat / ZOMSS

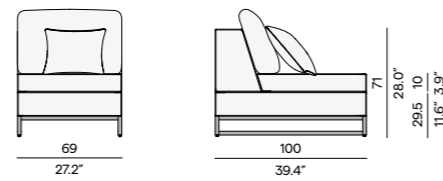

Right seat / ZORS

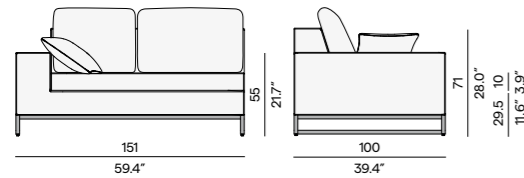

Large footstool / Sidetable / ZOFL

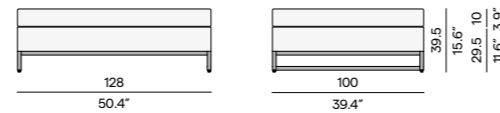

Corner / ZOCS

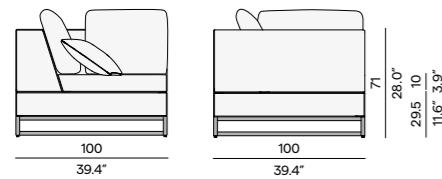

Medium footstool / Sidetable / ZOFM

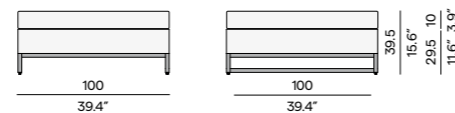

Large middle seat / ZOMSL

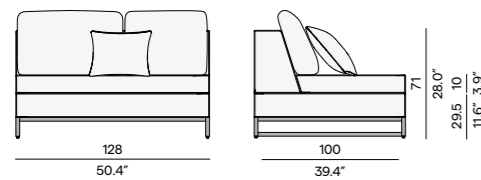

Small footstool / Sidetable / ZOFS

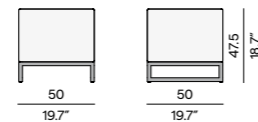

Lounger / ZOLO

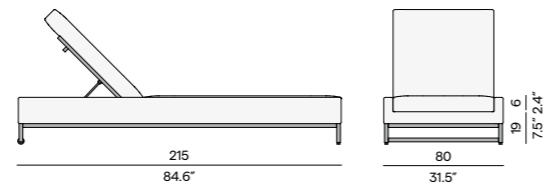

# Liner

Designed by Bram Bollen



## Materials & colours

Standard combinations

Frame - Finishing

PCA - outdoor fabric

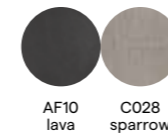
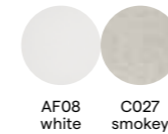

PCA - nautic leather

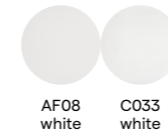

## Cushions

Suggested colour combo

(see page 286)

cw-smokey-3

sd-nautic leather white-1

## Features

Lounger with wheels

## Options

Protective cover (see page 294)

Chair / CH25

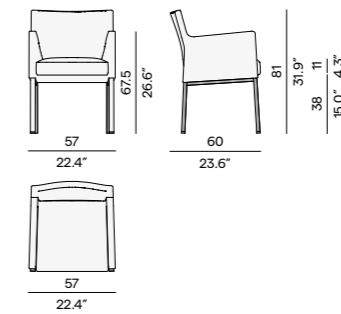

1S / 1S40

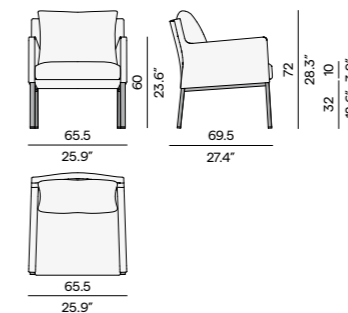

Lounger / LO53

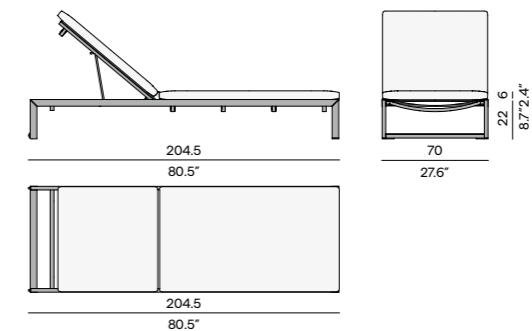





# Loop°

Designed by Gerd Couckhuyt



## Materials & colours

Frame - Finishing  
PCSTS - outdoor fabric

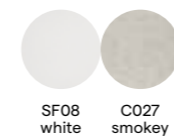

SF08 white  
C027 smokey

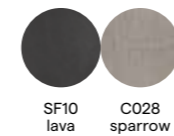

SF10 lava  
C028 sparrow

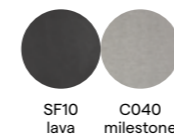

SF10 lava  
C040 milestone

PCSTS - nautic leather



SF08 white  
C033 white

## Dining chair / DC31

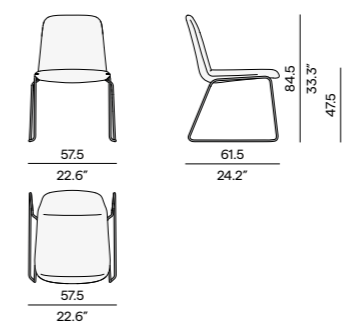

## Chair / CH35

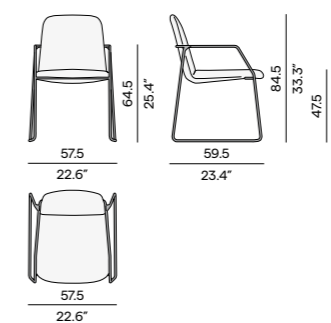

## Features

Stackable chair

## Options

- Protective cover (see page 294)
- Possibility to customise with fabrics from CAT. A and CAT. B



# Moon Island

Designed by Gerd Couckhuyt



## Materials & colours

### Frame

PCA



AF11  
Shingle

### Finishing

Nautic leather

Nautic Batyline®



C033  
white



T111  
sand

## Cushions

Suggested colour combo  
(see page 286)

tc-nebbia-1

sd-salty white-1

cw-cimento-2

sd-nautic leather white-1

## Options

- Protective cover (see page 294)
- Possibility to customise with fabrics from CAT. A and CAT. B

## Suggested concepts

### Concept 1

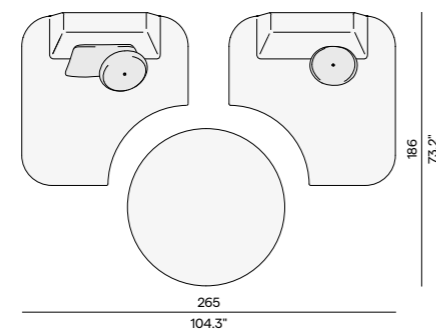

### Concept 2

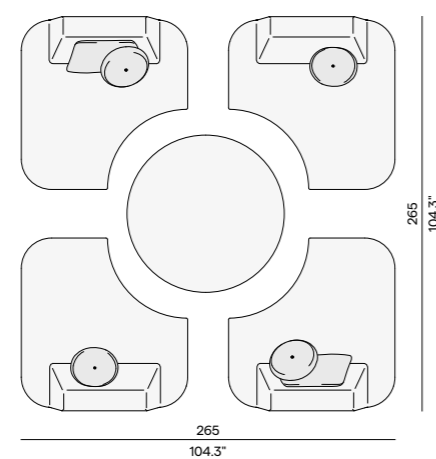

## Available items for customised compositions

### Left corner / MILCS

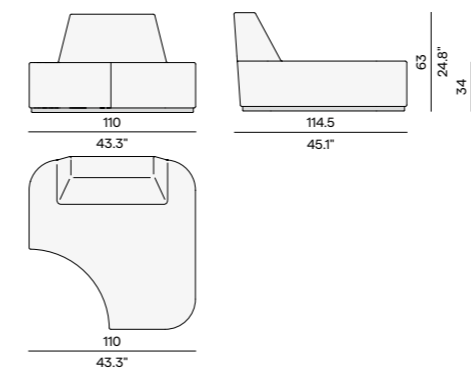

### Right corner / MIRCS

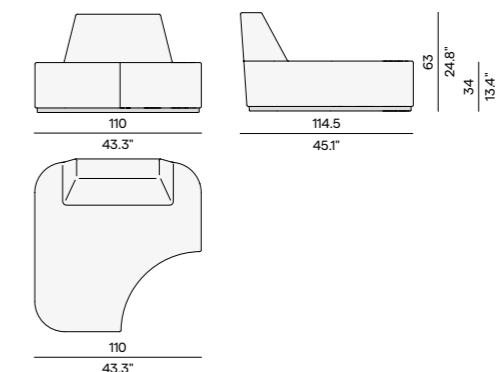

### Footstool / Sidetable 52 / MIFS52

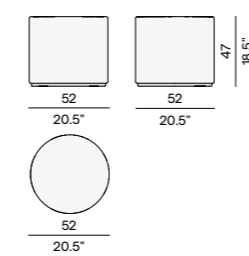

### Footstool / Sidetable 63 / MIFS63

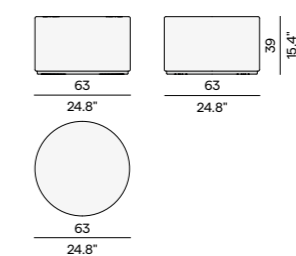

### Lounge table / Footstool 104 / MILT

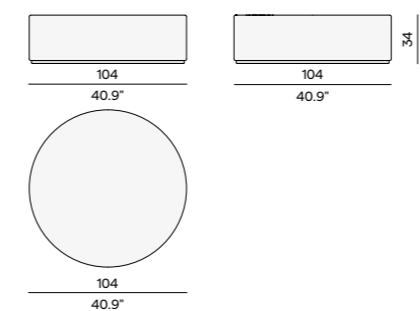



# San

Designed by Lionel Doyen



## Materials & colours

### Frame - Finishing

PCSTS - iroko

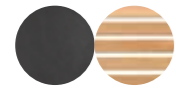

SF10  
lava

IR  
iroko

### Finishing accessory

Marble



MW  
carrara  
white

MB  
portoro  
black

## Cushions

Suggested colour combo  
(see page 286)

te-vanilla-1

tc-graphite-1

tc-nebbia-2

sd-salty white-1

cw-cimento-2

## Options



marble  
round 40

marble  
rectangular 60

movable  
back

### Bench (Base 200) / SN200

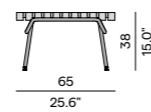
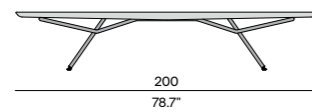

### Sofa / SNC1

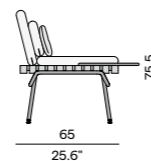
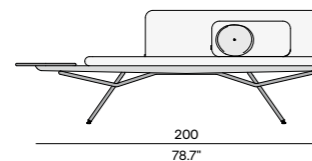

### Double 1 seater / SNC2

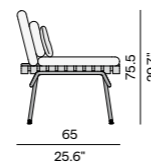
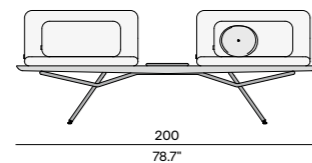

### Lounger / SNC3

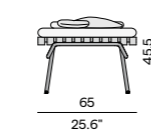
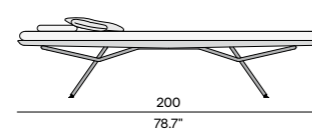

### Marble round 40 / SNMAR40

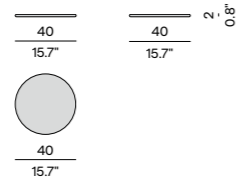

### Marble rectangular 60 / SNMAR60

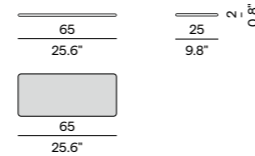





# Siena

Designed by Stephane De Winter



## Materials & colours

### Frame

Teak



T  
teak

### Finishing (only for chair and lounge)

#### Textiles



T003  
bronze



T004  
black

## Cushions

Suggested colour combo

(see page 286)

te-vanilla-2

cw-metallic-2

## Features

- Stackable chair
- Lounger with wheels

### Teak textiles chair - TKCH03

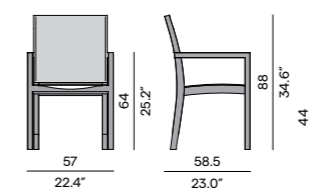

### Teak textiles lounge - TKLO02

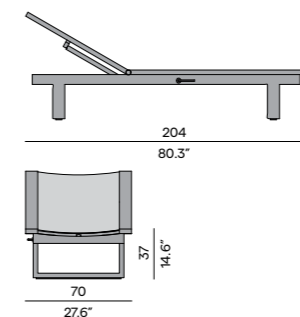

### Teak chair - TKCH02

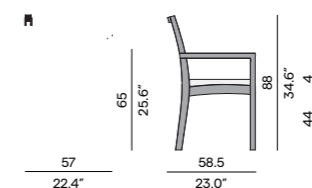

### Teak lounge - TKLO01

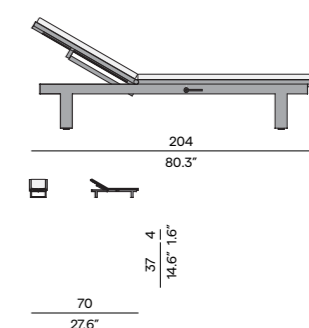

### Teak sidetable - TKCT01

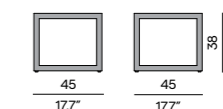

### Teak towel rack - TKTR01

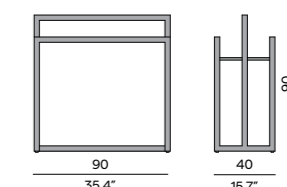



# Siena

Designed by Stephane De Winter



## Materials & colours

### Frame

Teak



T  
teak

### Table top

Full stone table top

bluestone 30mm granite 30 mm



00 - BD  
dark



00 - BL  
light



06 - GC  
caramel

satingo 30mm striped border  
satingo 20mm



01 - SB  
blue



09 - SN  
nero

Teak border + insert

bluestone 20mm granite 20 mm



40 - BD  
dark



40 - BL  
light



46 - GC  
caramel

satingo 20mm satingo 20mm



41 - SB  
blue



49 - SN  
nero

teak 35mm



1H43 - TL  
teak slats

## Dining tables

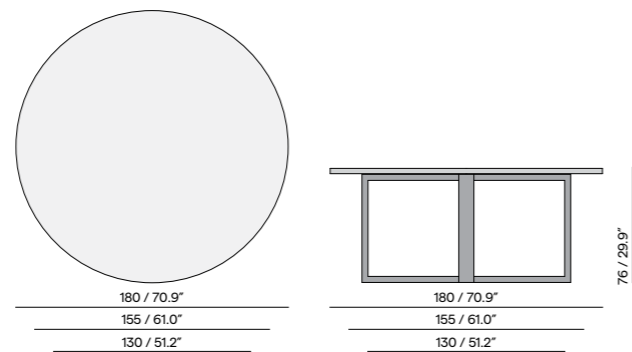
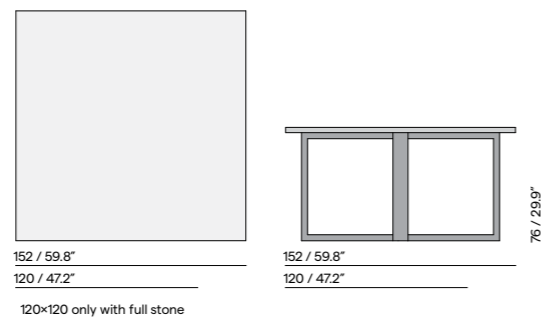
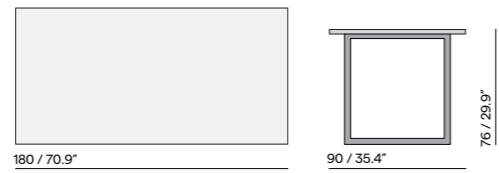

## Coffee tables

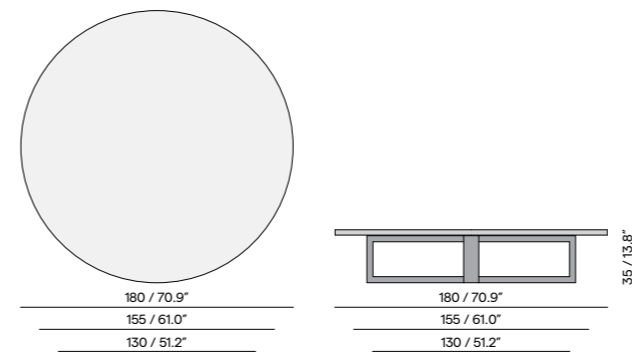
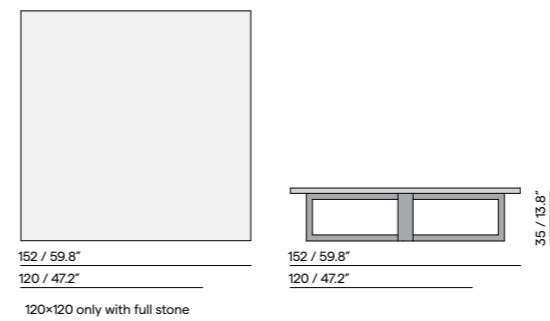
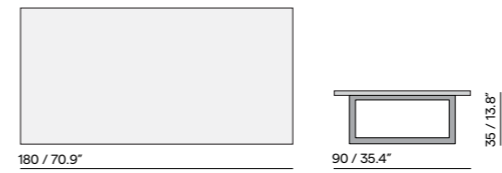

## Tabletops



full stone

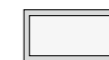

stone insert

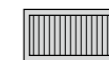

teak slats insert



# Cross Teak

Designed by Mads Odgård



## Materials & colours

### Frame - Finishing

Teak - textiles



### Customised finishing

Selected fabrics

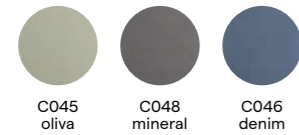

## Features

Folding chair

## Options

Possibility to customise with selected fabrics

### Chair / CH33TK

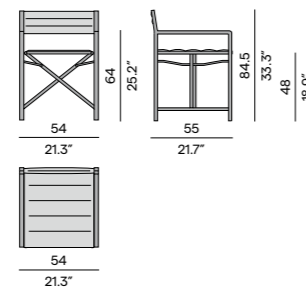

# Cross Alu

Designed by Mads Odgård



## Materials & colours

### Frame - Finishing

PCA - textiles

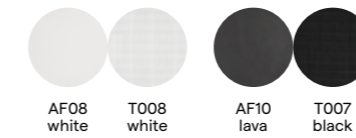

## Features

Folding chair

### Chair / CH33

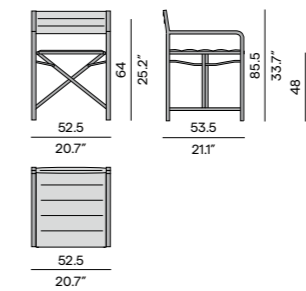



# River°

Designed by Stephane De Winter



## Materials & colours

### Finishing

Wicker 6mm



3W84  
old grey  
cord

### Cushions

Suggested colour combo  
(see page 286)  
sd-vanilla-1  
sd-dune-2

### Features

Lounger with wheels

### Options

Protective cover (see page 294)

1S / 1S45

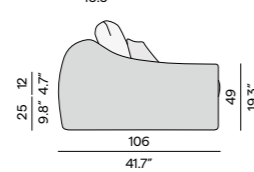
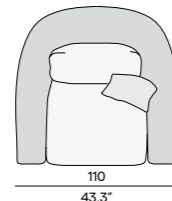
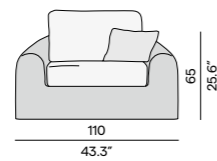

3S / 2S91

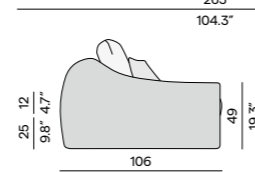
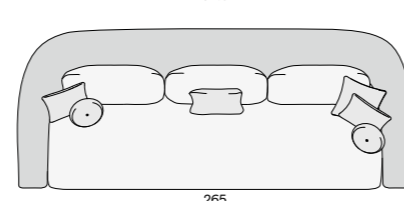
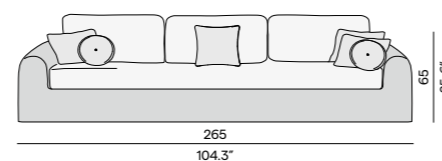

Sunbed small / SB05

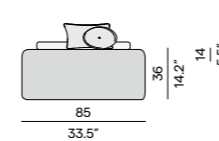
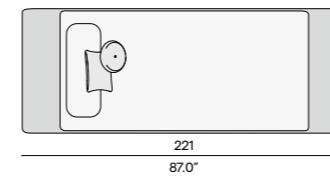
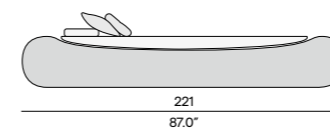

Sunbed large / SB05XL

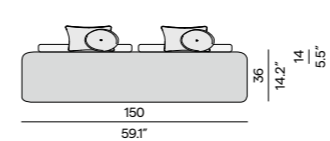
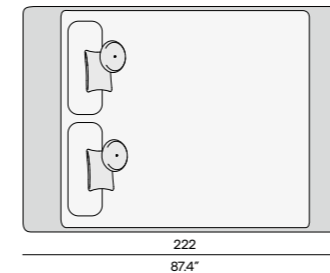
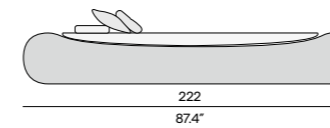

Round round chair / CH42

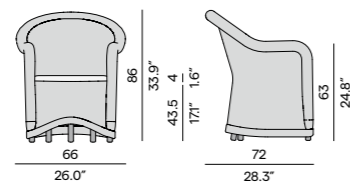



# Mood

Designed by Stephane De Winter



## Materials & colours

### Finishing

Wicker 2mm



### Cushions

Suggested colour combo  
(see page 286)  
te-sparrow-1  
sd-smokey-1

### Options

Protective cover (see page 294)

## Chair / CH29

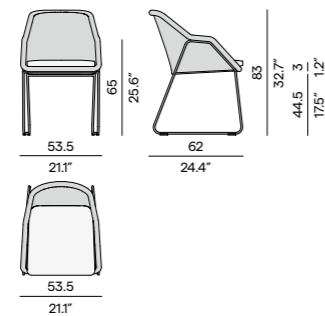

## Barstool 80 / BS64

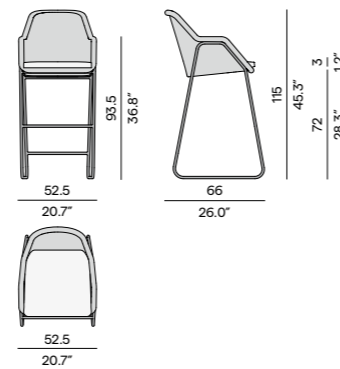

## 1S / 1S39

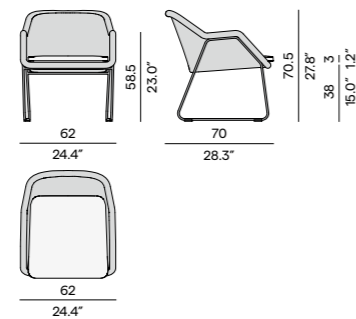

## Barstool 60 / BS64L

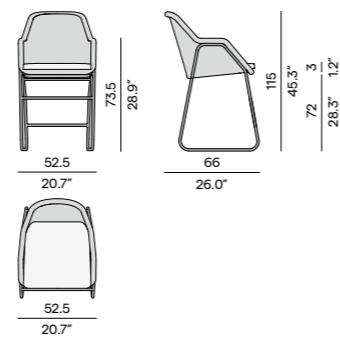

## Materials & colours

### Frame

PCSTS



### Table top

IR - iroko



6K60 iroko

CE - ceramic 6mm



6K60 white

6K64 quartz

6K66 perla

CE - ceramic 12mm



5K53 fossil

5K54 travertin geo

5K67 basalt black

5K58 marble white

5K59 marble black



5K66 perla



5K68 concrete



5K69 emperador

GL - acid etched glass 10mm



2G70 white

2G71 taupe

2G72 black

2G73 sand

TR - Trespa® 13mm



2T90 white

2T92 black

### Options

Protective cover (see page 294)

## Lounge table

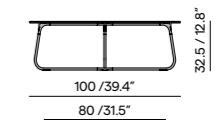
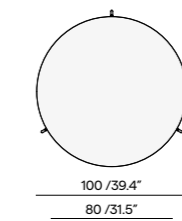

## Coffee table

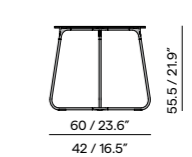
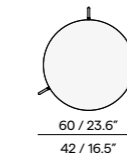



# San Diego

Designed by Stephane De Winter



## Materials & colours

**Finishing**  
wicker 8mm



4W84  
old grey  
cord

## Cushions

Suggested colour combo  
(see page 286)  
te-vanilla-1  
tc-graphite-1

## Features

- Modular system
- Lounger with wheels

## Options

Protective cover (see page 294)

## Suggested concepts

Concept 1

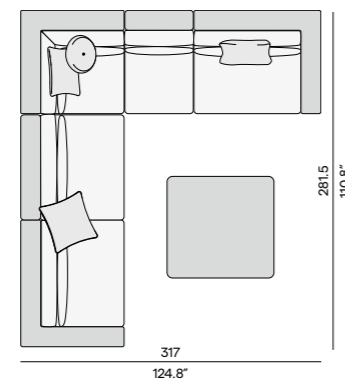

Concept 2

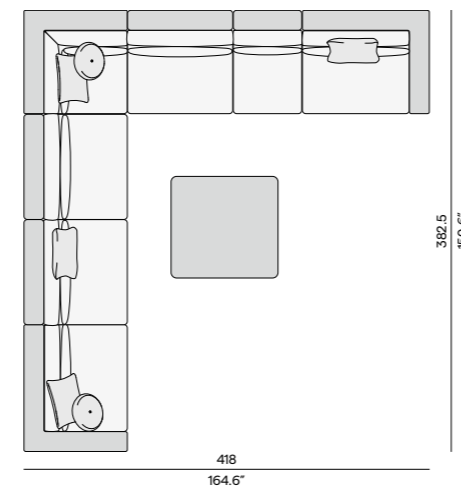

Concept 3

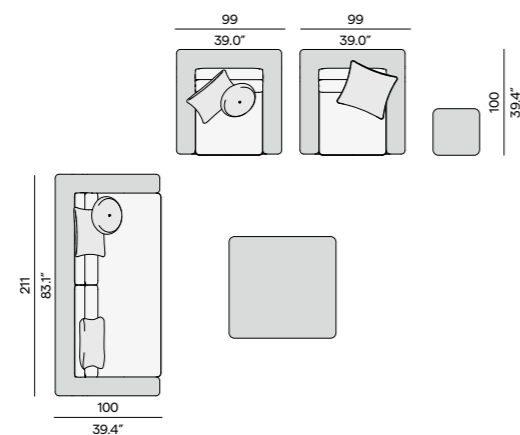

Concept 4

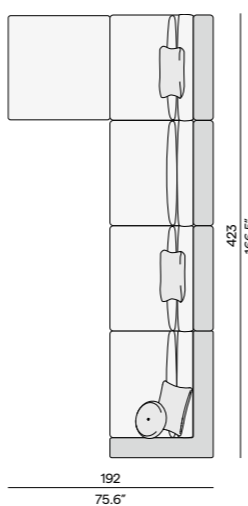

## Available items for customised compositions

Cord chair / CH19

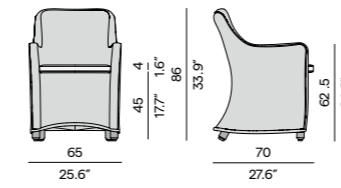

Cord left seat / SDLS

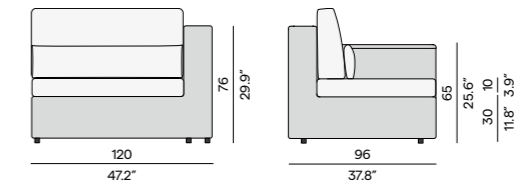

Cord wing chair / CH23

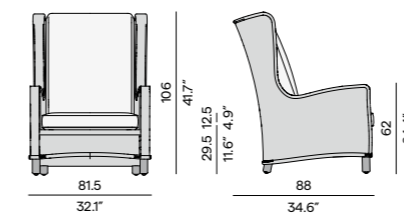

Cord right seat / SDRS

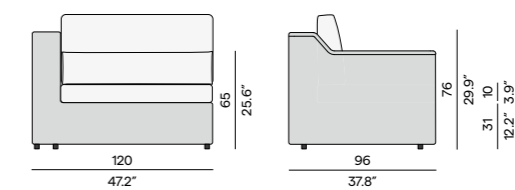

Cord 1S / 1S35

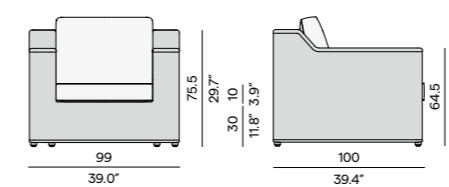

Cord corner / SDCS

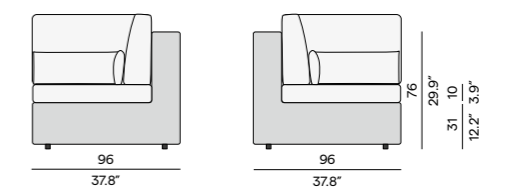

Cord 2.5S / 2S96

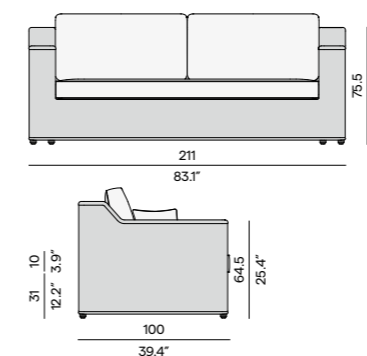

Cord Small middle seat / SDMSS

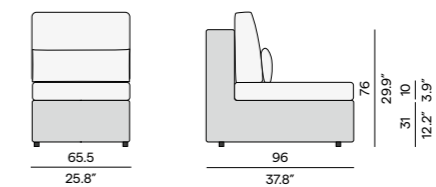

Cord Large middle seat / SDMSL

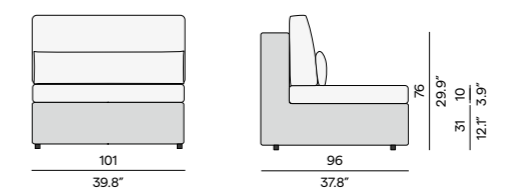



# San Diego

Designed by Stephane De Winter



Cord small footstool / Sidetable / FR80S

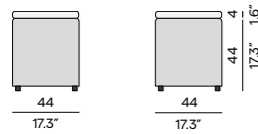

Cord Medium footstool / Sidetable / FR80M

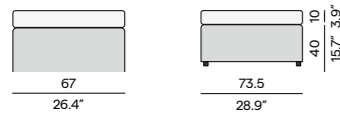

Cord Large footstool / Sidetable / SDFL

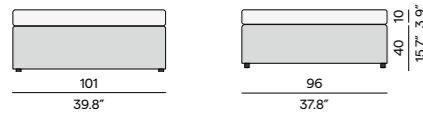

Cord Lounger / SDLO

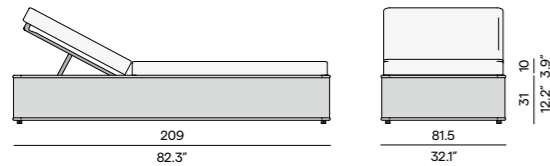

# Malibu

Designed by Stephane De Winter



## Materials & colours

### Finishing

wicker 2,8mm



2W23 camel

### Cushions

Suggested colour combo  
(see page 286)

te-vanilla-1  
tc-graphite-1  
sd-vanilla-1

Cord Square chair / CH18

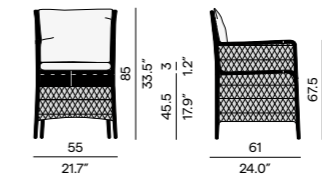

Cord Square coffee table / CT83



Cord Square medium footstool / Sidetable / FR81

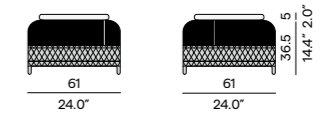

Cord Square 1S / 1S36

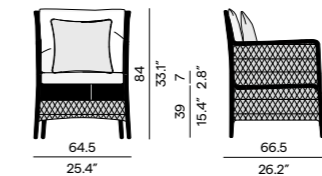

Cord Square sidetable / CT84

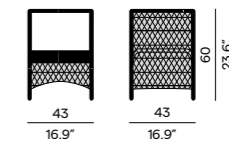

Cord Square 2.5S / 2S97

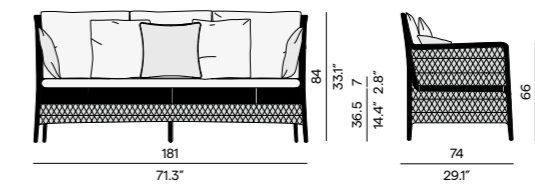

Cord Square patio chair / LO49

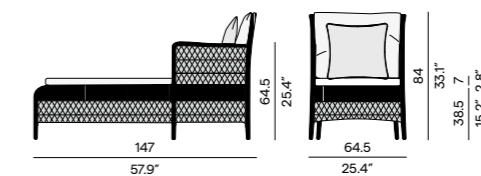





# Latona

Designed by Stephane De Winter



## Materials & colours

Frame - Finishing

PCA - textiles



AF08  
white

T008  
white

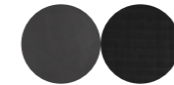

AF10  
lava

T007  
black

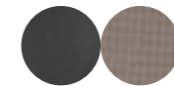

AF10  
lava

T010  
mocca

### Textiles Chair / CH12A

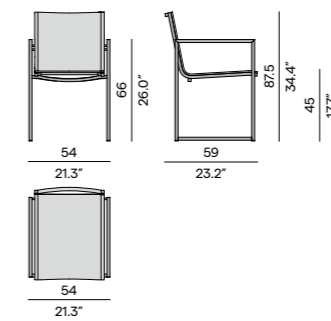

### Helios Textiles Barstool 80 / BS65

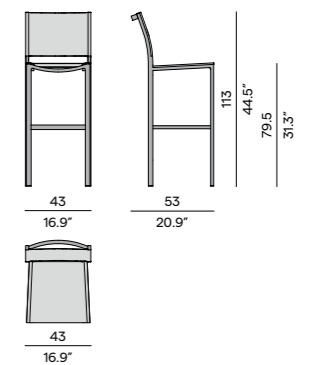

### (Helios) Textiles Lounger / LO54

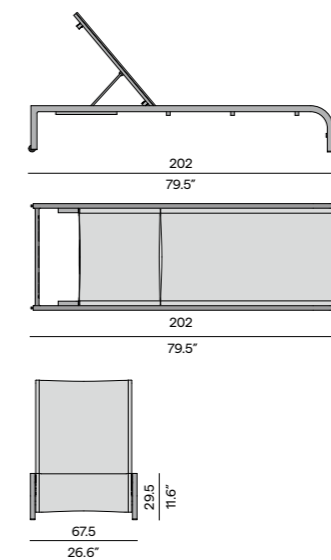

### (Helios) Textiles Barstool 60 / BS65L

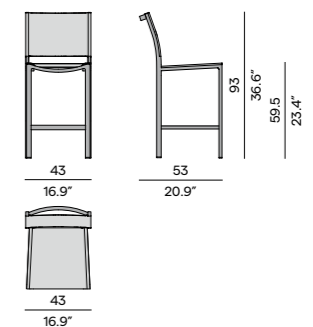



# Fuse

Designed by Stephane De Winter



## Materials & colours

### Frame - Finishing

PCA - iroko



## Cushions

Suggested colour combo  
(see page 286)

white:  
cw-metallic-2

lava:  
tc-nebbia-2  
te-vanilla-1

## Features

- Modular system
- Stackable lounger

## Options

Protective cover (see page 294)

Concept 1

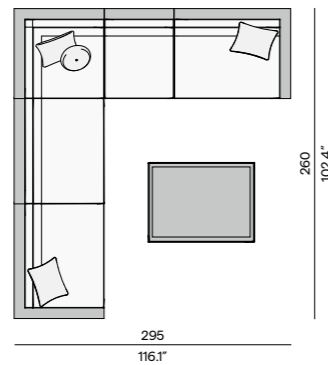

Concept 2

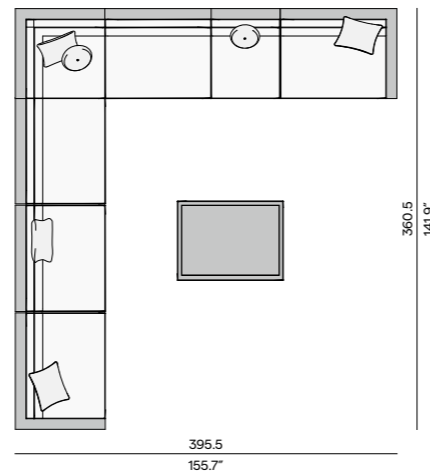

Concept 3

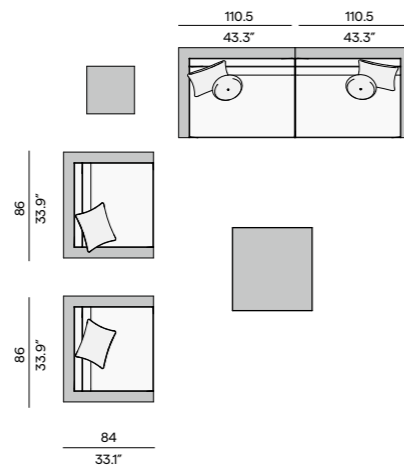

Concept 4

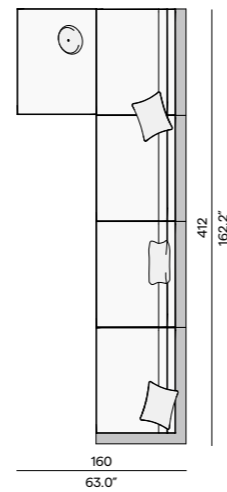

## Available items for customised compositions

1S / FE1S

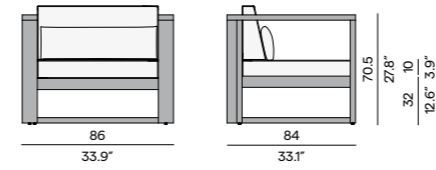

Left seat / FELS

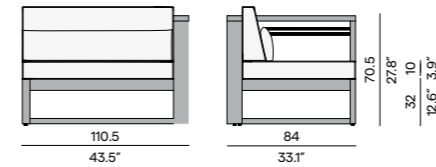

Right seat / FERS

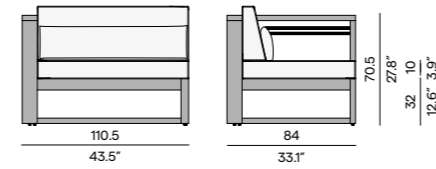

Corner seat / FECS

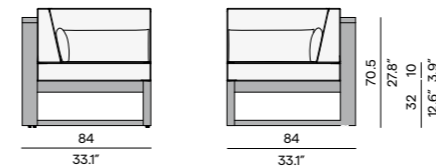

Small middle seat / FEMSS

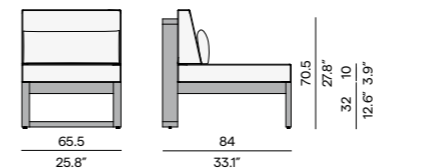

Large middle seat / FEMSL

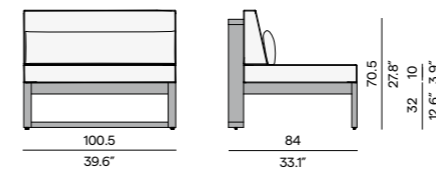

Medium footstool / Sidetable / FEFM

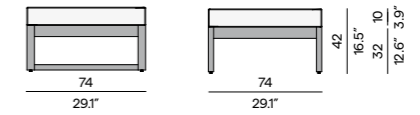

Large footstool / Sidetable / FEFL

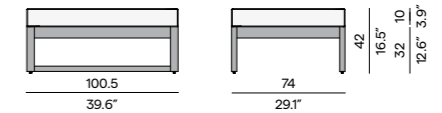

Lounger / FELO

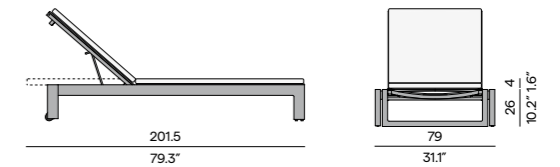

Sidetable / CT88

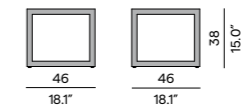

Bench 300 (full alu top) / BE300

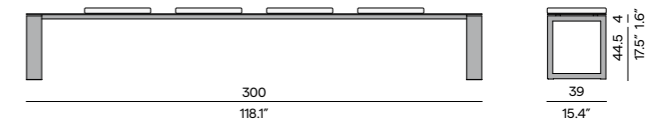

Bench 45 (full alu top) / BE45

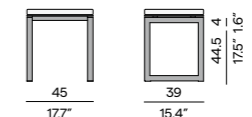



# Fuse

Designed by Stephane De Winter



## Materials & colours

### Frame

PCA



### Table top

TL - teak 35mm CE - ceramic 6mm

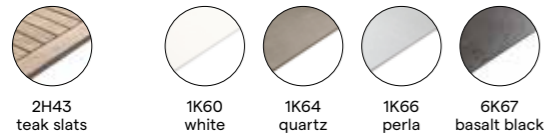

CE - ceramic 12mm



GL - acid etched glass 10mm



TR - Trespa® 10mm

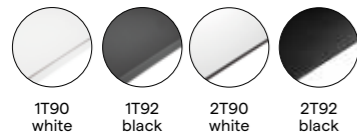

## Options

Protective cover only for Trespa® / glass / ceramic table tops (see page 294)

### Dining table

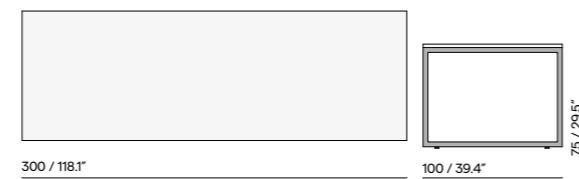

### Dining table

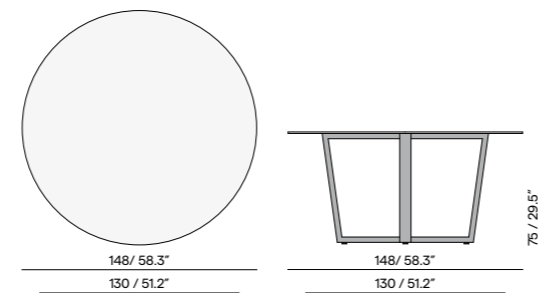

### Bench 300

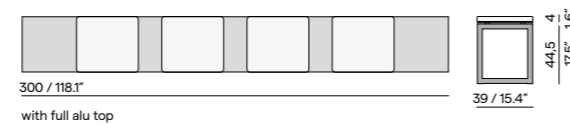

### Bench 45

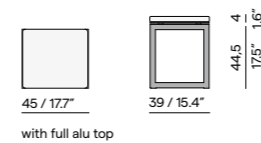



# Luna

Designed by Stephane De Winter



## Materials & colours

### Frame

PCA



### Table top

CE - ceramic 6mm in frame



GL - acid etched glass 10mm

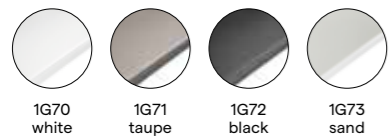

## Features

- Led-Lighting: set includes battery, charger and remote control
- Easy sliding syste for extendible function
- Integrated table top

## Options

Protective cover (see page 294)

### Extendible dining table 240/360

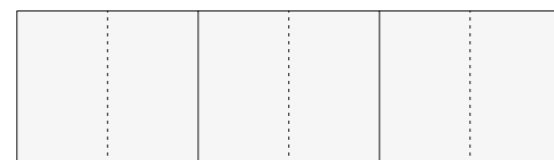
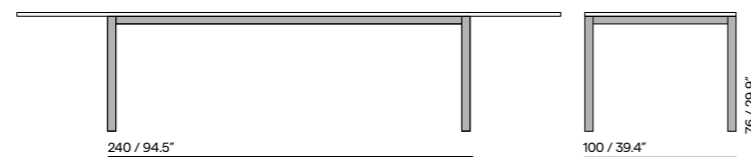

360 / 141.7"

open dimensions



240 / 94.5"

closed dimensions

# Trento

Designed by Stephane De Winter



## Materials & colours

### Frame

PCSTS

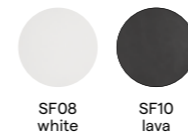

### Table top

TL - teak 35mm CE - ceramic 6mm

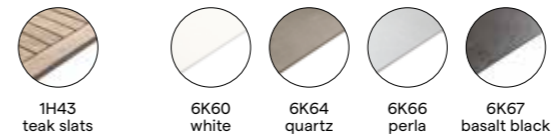

GL - acid etched glass 10mm

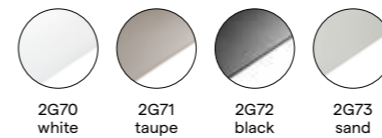

## Features

2 wheels for easy moving (not for low dining table)

## Options

Protective cover only for Trespa® / glass / ceramic table tops (see page 294)

### Dining table

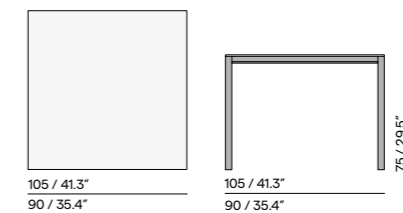

### Coffee table

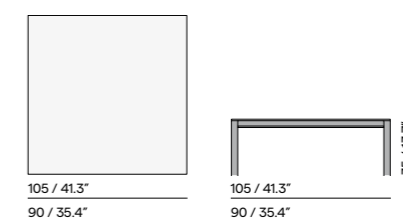
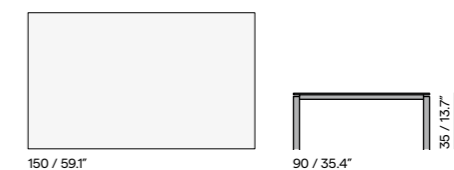



# Quarto

Designed by Stephane De Winter



## Materials & colours

### Frame

PCA



### Table top

TL - teak 35mm CE - ceramic 6mm

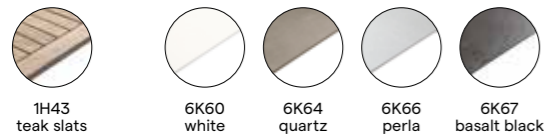

GL - acid etched glass 10mm

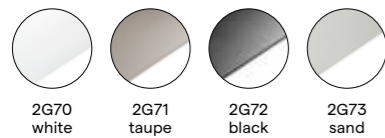

## Options

Protective cover only for Trespa® / glass / ceramic table tops (see page 294)

### Bar table

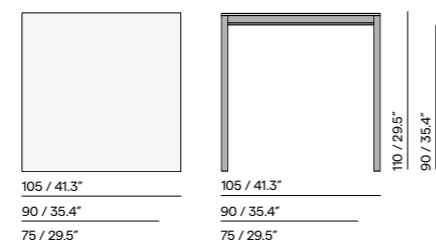
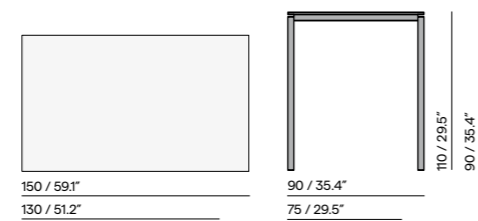

### Dining table

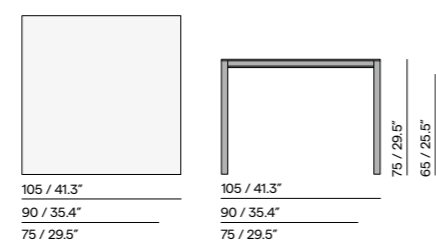

### Coffee & lounge table

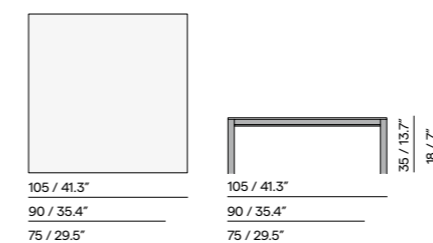
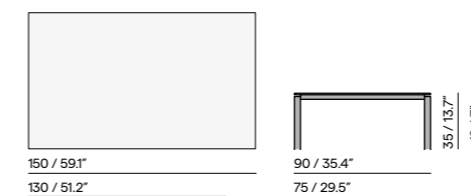



# Livorno

Designed by Stephane De Winter



## Materials & colours

### Frame

Teak



T  
teak

### Table top

#### Full stone table top

bluestone 30mm granite 30mm satingo 30mm striped border satingo 20mm



00 - BD dark 00 - BL light 06 - GC caramel 01 - SB blue 09 - SN nero

#### Full stone table top with parrot's bill

bluestone 30mm granite 30mm



60 - BD dark 60 - BL light 61 - SB blue

#### Teak border + insert

bluestone 20mm granite 20mm satingo 20mm satingo 20mm



40 - BD dark 00 - BL light 46 - GC caramel 41 - SB blue 49 - SN nero

teak 35mm



1H43  
teak slats

## Dining tables



265 / 104.3"

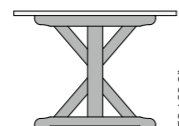

107.5 / 42.3"

76 / 29.9"

## Tabletops



full stone



stone insert

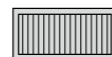

teak slats insert





# Milano

Designed by Stephane De Winter



## Materials & colours

### Frame

Teak



T  
teak

### Table top

#### Teak border + insert

bluestone 20mm



40 - BD  
dark



40 - BL  
light

granite 20 mm



46 - GC  
caramel

satingo 20mm



41 - SB  
blue

satingo 20mm



49 - SN  
nero

teak 35mm



1H43  
teak slats

### Extendible dining table

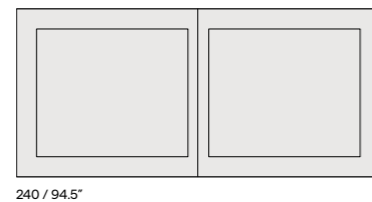
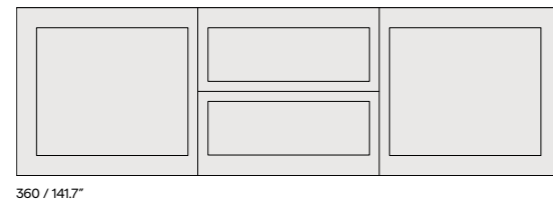
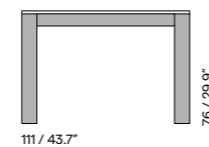

closed dimensions

### Tabletops



stone insert



teak slats insert

# Napoli

Designed by Stephane De Winter



## Materials & colours

### Frame

PCA



AF08  
white



AF10  
lava



AF11  
shingle

### Table top

TL - teak 20mm CE - ceramic 6mm with border



1H43  
teak slats



1K60  
white



1K64  
quartz



1K66  
perla



1K67  
basalt black

GL - acid etched glass 10mm with border



1G70  
white



1G71  
taupe



1G72  
black



1G73  
sand

TR - Trespa® 13mm



2T90  
white



2T92  
black

## Options

Protective cover only for Trespa® / glass / ceramic table tops  
(see page 294)

### High bistro table

With border or teak slats



75 / 29.5"  
60 / 23.6"



75 / 29.5"  
60 / 23.6"

110 / 43.3"

Without border



90 / 35.4"  
75 / 29.5"  
60 / 23.6"



90 / 35.4"  
75 / 29.5"  
60 / 23.6"

110 / 43.3"

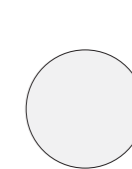

80 / 31.5"

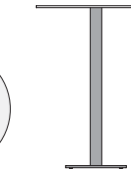

80 / 31.5"

110 / 43.3"

### Bistro table

With border or teak slats



75 / 29.5"  
60 / 23.6"

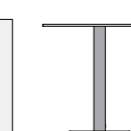

75 / 29.5"  
60 / 23.6"

74.5 / 29.3"

Without border



90 / 35.4"  
75 / 29.5"  
60 / 23.6"

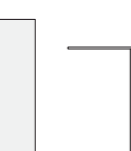

90 / 35.4"  
75 / 29.5"  
60 / 23.6"

74.5 / 29.3"

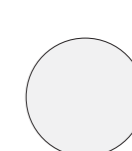

80 / 31.5"

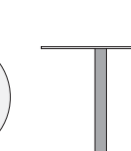

80 / 31.5"

74.5 / 29.3"



# Side tables°



## Materials & colours

Frame + table top

PCA

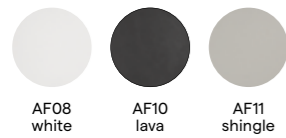

Table top (only for round 42)

iroko



IR  
iroko  
(only for ST05)

Closed 36 / ST01

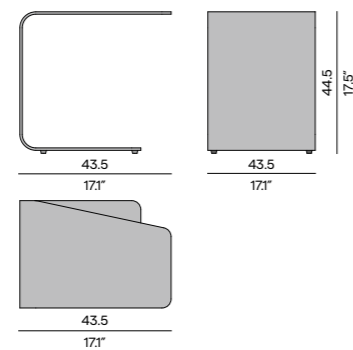

Open 32 / ST02

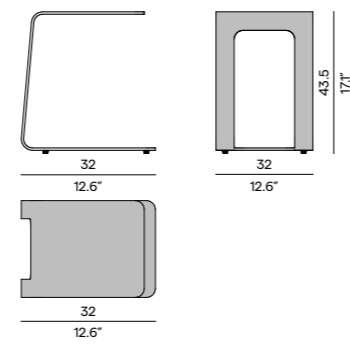

Round 48 / ST03

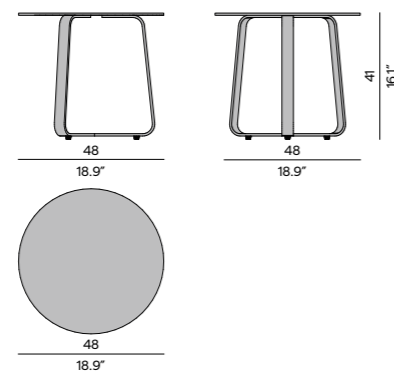

Round 42 / ST05

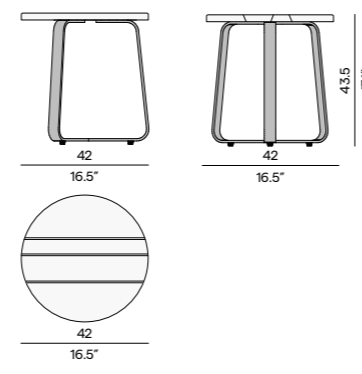

Vitral 80 (Set of 2) / ST04-38

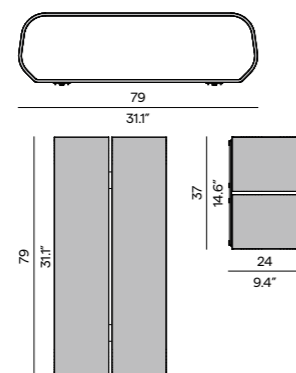

Vitral 80 (Set of 3) / ST04-58

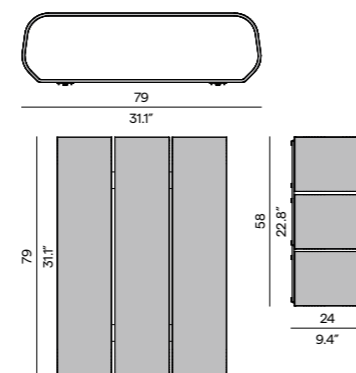

# Rugs°

## Linear°



## Materials & colours

Finishing

polyolefin

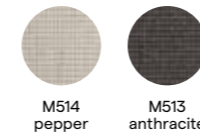

Detail

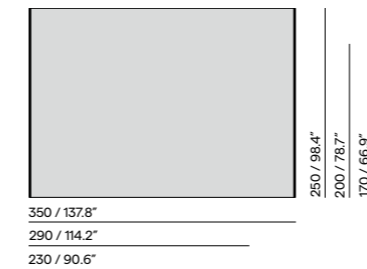
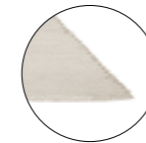

## Twist°



## Materials & colours

Finishing

textylene



Detail

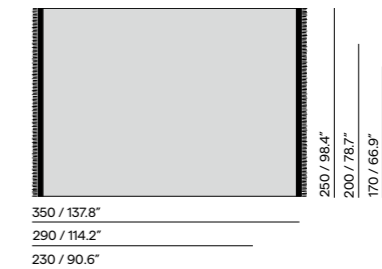
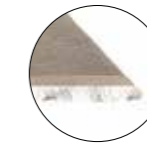



# Lighting



## Materials & colours

Frame - Finishing  
PCA - iroko



Flame Lumo small / LUM-S

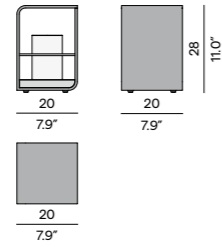

Flame Lumo medium / LUM-M

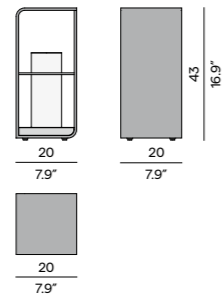

Flame Lumo large / LUM-L

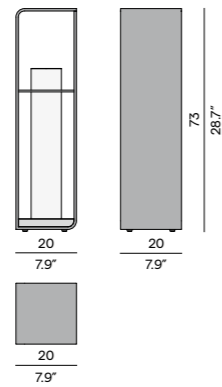

# Towel Rack



## Materials & colours

Frame  
teak



Teak towel rack / TKTR01

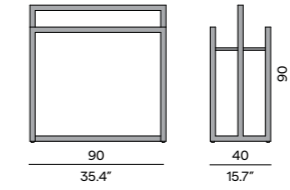

# Trays



## Materials & colours

Base + frame  
PCA



Tray 48x48 / TRAY48x48

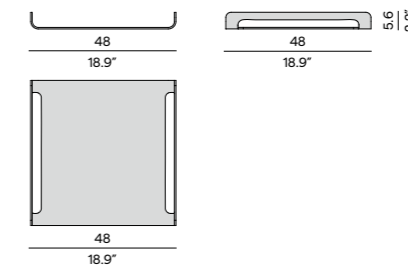

Tray 60x28 / TRAY60x28

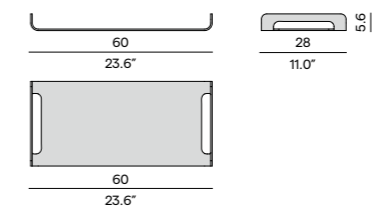





# Poufs

## Kumo



Finishing  
all fabrics

### Kumo POUF 50 / KOPF50

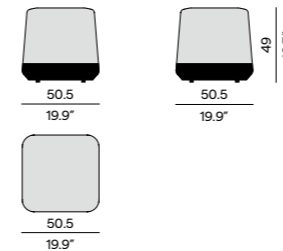

## Moon Island



Finishing  
all fabrics

### Moon island Pouf 52 / MIFS52

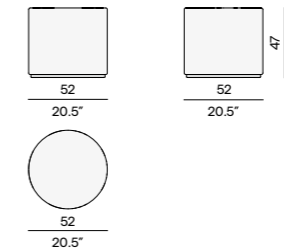

### Moon island Pouf 63 / MIFS63

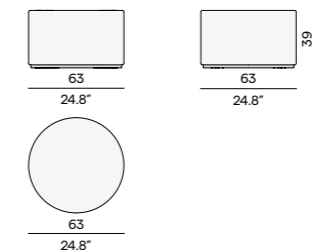

## Touch



Finishing  
all fabrics

### Touch 112x65 / THPF112

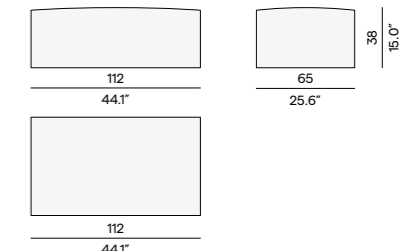

### Touch Ø82 / THPF82

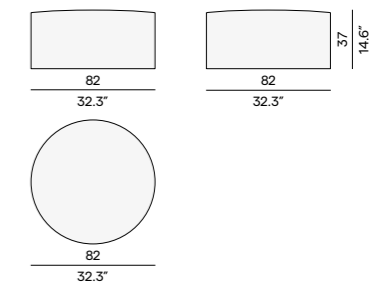

### Touch Ø52 / THPF52

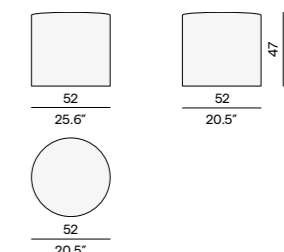



# Umbrellas



## Materials & colours

### Frame

Aluminium Teak

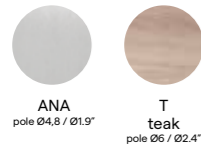

ANA pole Ø4,8 / Ø1,9"  
T teak pole Ø6 / Ø2,4"

### Base

Granite

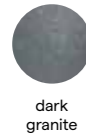

dark granite

### Finishing - fabrics

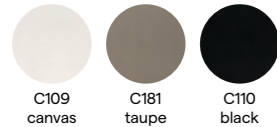

C109 canvas  
C181 taupe  
C110 black

Square umbrella 300x300 / CEPAL300x300  
Square umbrella 350x350 / CEPAL350x350

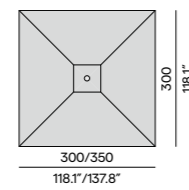
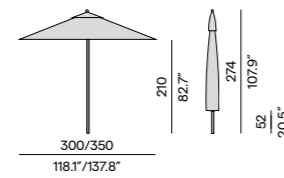

Round umbrella Ø350 / CEPAL350xR  
Round umbrella Ø300 / CEPAL300xR

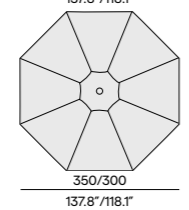
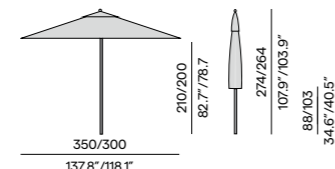

Stone base 55kg / UBAG55

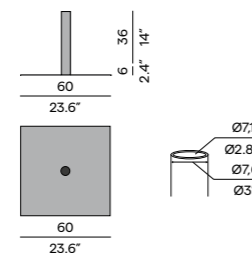

Rectangular umbrella 300x400 / CEPAL300x400

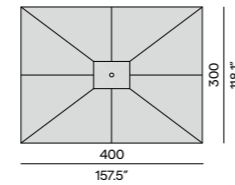
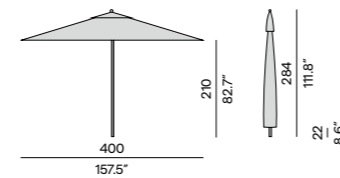

Stone base 80kg with wheels / UBAGB80W

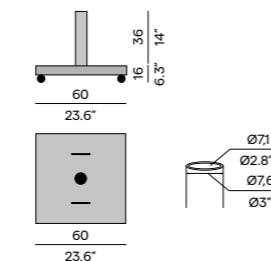

## Materials & colours

### Frame

Aluminium PCA



ANA pole Ø3,9 / Ø1,54"  
AF08 white pole Ø3,9 / Ø1,54"  
AF7 black pole Ø3,9 / Ø1,54"

### Finishing - fabrics

Standard

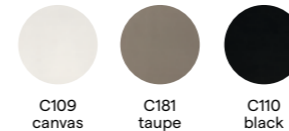

C109 canvas  
C181 taupe  
C110 black

Selected fabrics

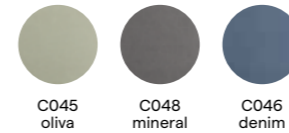

C045 oliva  
C048 mineral  
C046 denim

## Features

- Mechanism in anodised aluminium
- Protective cover included

Small aluminium umbrella (4 ribs) 180x180 / SCP-180x180

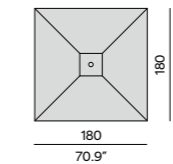
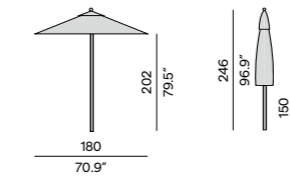

Iron base 21kg / UBAIB25

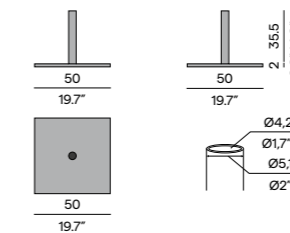



# Cushion boxes\*



## Materials & colours

### Finishing

wicker 2mm



1W23  
camel

1W31  
off white

1W90  
black

## Features

Cushion boxes can be locked

Cord cushion box small / CCCBS

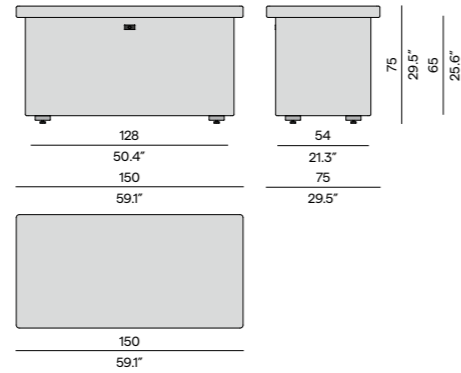

Cord cushion box large / CCCBL

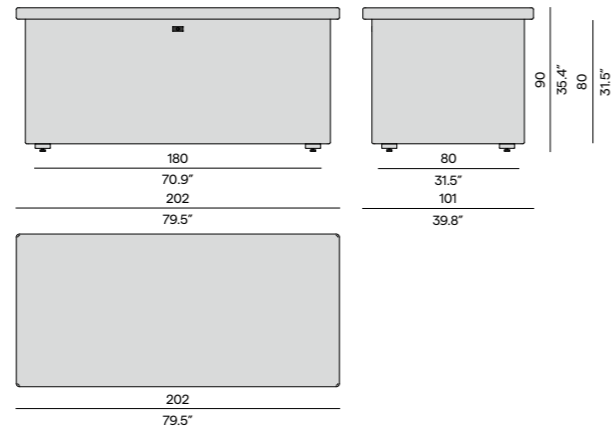

## Materials & colours

### Finishing

PCA

Teak



AF08  
white

AF10  
lava

T  
teak

## Features

Cushion boxes can be locked

PCA Cushion box large / FECBL

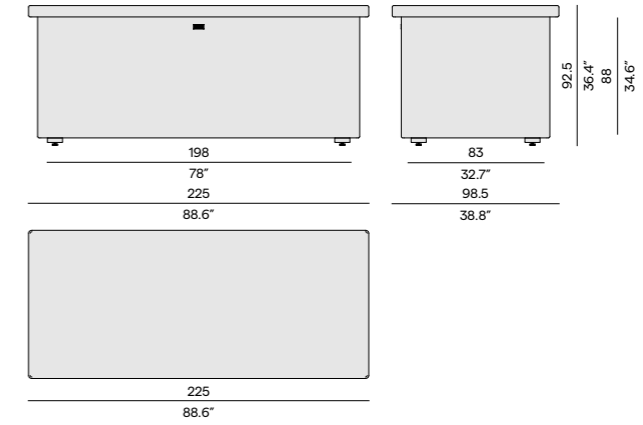

Teak cushion box large / TKCB01

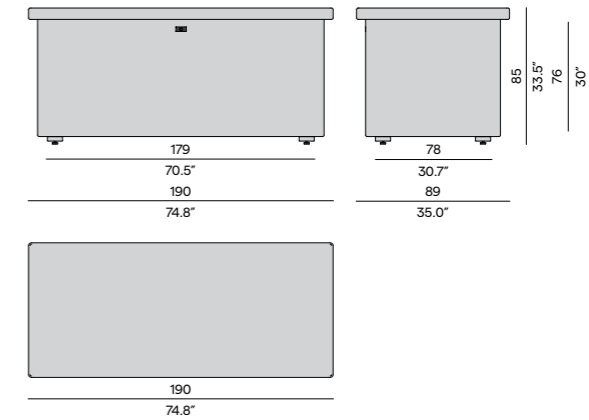





# Materials & fabrics



# Materials

## Powder coated aluminium (PCA)



AF07 black      AF08 white      AF10 lava



AF11 shingle      AF13 flint

- Fluidised powder coating applied to the aluminium structure by electrostatic spray. For maximum solidity and resistance of the powder coating, the material is heated at a temperature between 160°C (320°F) and 210°C (410°F) (T° according to the type of powder)
- Easy to clean and maintain (for specific maintenance see p. 298)
- For outdoor and indoor use

## Stainless steel (PCSTS)



SF08 white      SF10 lava      SF11 shingle      SF13 flint

- Electropolished stainless steel 316L and 304L. The treatment concentrates chrome, nickel and other materials of the steel into the surface improving the corrosion resistance and leaving it with a lasting bright finish.
- Technique used in the naval industry
- Recommended near the sea, a swimming pool, in very industrial areas, or near a railway
- For outdoor and indoor use

## Wrought iron (PWI)



WF08 white      WF10 lava      WF11 shingle



WF13 flint

- Sanded solid forged iron, with anti-oxidation treatment (phosphatation) and heated at 180°C (356°F) min.
- 100% UV-resistant, does not discolour in the light and sun
- Swimming pool and sea water resistant and repellent
- Easy to clean and maintenance free
- For outdoor and indoor use
- Each item of furniture is assembled by hand
- 100% recyclable

## Quaryl® (quartz composite)



Q8 quarry®  
(only Elements)



- Blend of natural quartz and high-quality acrylic.
- Frost- and UV-resistant making the material highly suitable for outdoor use.
- Very impact-resistant, shockproof and scratch-resistant
- Smooth, non-porous and closed surfaces easy to clean and to maintain
- Extremely stable and durable
- Ecological and 100% recyclable

## Rope (R)



1R01 bronze 4.5mm      2R01 bronze 11mm  
1R02 silver 4.5mm      2R02 silver 11mm      3R02 silver 45mm  
1R03 anthracite 4.5mm      2R03 anthracite 11mm      3R03 anthracite 45mm      4R04 anthracite 45mm  
1R04 pepper 4.5mm      4R04 pepper 45mm

- Blend of Textilene® and polyolefin, UV-resistant
- Swimming pool and sea water resistant and repellent
- Easy to clean and maintain. For specific maintenance, woven & textiles cleaner (see p. 298)
- Each item of furniture is assembled by hand
- Recyclable, GreenGuard certified, REACH certified



# Materials

## Wicker



1W23  
camel  
2mm



2W23  
camel  
2.8mm

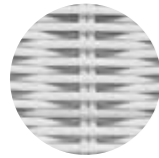

1W31  
off white  
2mm



1W44  
hazel  
2mm



3W84  
old grey  
6mm



4W84  
old grey  
8mm

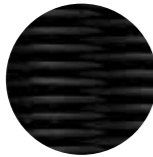

1W90  
black  
2mm

### The fibres

- A synthetic fibre (HDPE), high quality thermoplastic fibre
- Resistant to great variations in temperature, even extreme, from -25°C (-13°F) to + 70°C (158°F)
- Fibre dyed in the mass, UV-resistant, does not discolour in the light and sun
- Swimming pool and sea water resistant and repellent
- UV tested 3500 h of exposure DIN 53387 Xenon Arc radiation
- High stability with traction resistance >20 MPA (ISO527)
- Easy to clean and maintain, for specific maintenance, woven & textile cleaner (see p. 298)
- For outdoor and indoor use
- Each item of furniture is assembled by hand
- Toxin-free, ecological, 100% recyclable

## Teak (τ)



AT  
aged teak



T  
teak

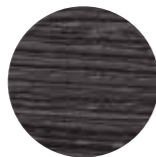

TN  
brushed teak nero

- Superior quality teak wood (VINIR & HARA) aged 60 to 80 years, sourced from ecological plantations
- Great stability under the effect of UV radiation, chlorine and sea water
- Easy to clean, various specific treatments possible (see p. 298)
- For outdoor and indoor use
- 100% recyclable

## Iroko (IR)



IR  
iroko

- Superior quality West African hardwood – durability classification 1
- Great stability under the effect of UV radiation, chlorine and seawater
- Easy to clean, standard pre-treated with wood protector water repellent (see p. 298)
- For outdoor and indoor use
- 100% recyclable

## Trespa® (HPL)



1T90-2T90  
white



1T92-2T92  
black

Trespa® is a flat thermo hardening resin-based plate made by compressing wood fibers at high pressure and high temperature (HPL - High Pressure Laminate). A special surface made with the patented EBC technology ensures durability and scratch resistance. Manutti works with 10mm and 13 mm thick plates and comes in all decors with a black finished border.

## Acid etched glass



1G70-2G70  
white



1G71-2G71  
taupe



1G72-2G72  
black



1G73-2G73  
sand

- Hardened glass, acid etched on the top, coloured on the bottom side.  
Specific gravity: 2.5 kg
- Colour fastness: differences in colour between different table tops can occur. These are caused by the different production batches in which they were made. A colour difference of delta E = 2, measured on the surface of the glass, is acceptable
- Tensile strength: intrinsic tensile strength 10,000 N/mm<sup>2</sup>
- Scratch resistance: no value available, but clearly sharp objects may cause scratches on the surface of the glass
- Thermal conductivity: 0.8 W/mK
- For outdoor and indoor use

## Tempered glass



### Glass

- Called tempered glass or safety glass
- Only obtainable in transparent or white toughened glass within the Manutti collection
- Hardened glass with a min. thickness of 6 to 8 mm depending on application
- Identical design to glass for car industry



# Materials

## Ceramic 6 mm



6K60  
white

6K64  
quartz

6K66  
perla



6K67  
basalt black

## Ceramic 12 mm

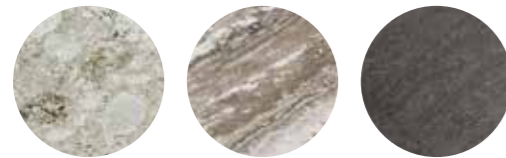

5K53  
fossil

5K54  
travertin geo

5K67  
basalt black

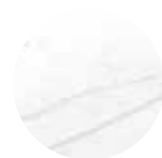

5K58  
marble white



5K59  
marble black



5K66  
perla



5K68  
concrete



5K69  
emperador

## Ceramics

The Manutti ceramic table tops are composed of sand, clay and natural stone formed into a layer which is heated at 1100°C. The 3 mm plates are cooled down and are glued together with a resin of polyurethane and fibre glass.

A few characteristics of ceramics are:

- Hygienic surface
- Colourproof
- Resistance to fire and high temperatures
- Impermeability
- Resistance to bending, scratching
- Resistance to wear and tear
- Resistance to chemical products
- Environment friendly
- For outdoor and indoor use

## Stone

### Straight border

Bluestone 30 mm

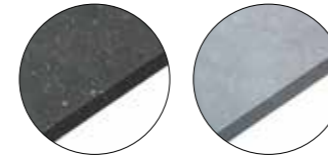

00BD  
dark

00BL  
light

Granite 30 mm

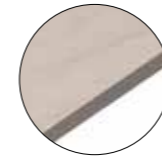

06GC  
caramel

Satingo 30 mm striped

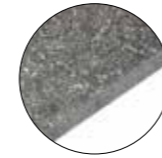

01SB  
blue

Satingo 20 mm

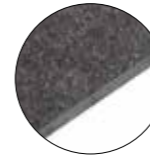

09SN  
nero

### Parrot's bill

Bluestone 30 mm

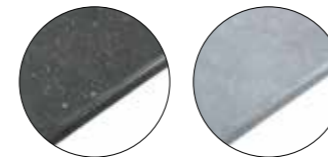

60BD  
dark

60BL  
light

Satingo 30 mm

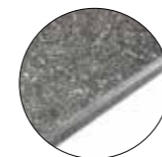

61SB  
blue

## Belgian bluestone

Belgian bluestone or "Little Granite" is a limestone with a more or less pronounced natural blue/grey colour, which is characterized by the presence of a large number of fossilised crinoids. This type of bluestone is only quarried in Belgium.

- It develops a natural patina
  - Use: outdoors, changes due to the action of rain and UV-rays to its original pale blue-grey colour
  - Use: indoors in the course of time, it develops a deeper colour
- Bluestone is susceptible to products and scratches
- Belgian bluestone can often contain a number of white veins<sup>1</sup>, black lines, spots and fossils<sup>2</sup>
- Depending on the finishing, the stone has a different look

<sup>1</sup> "White veins" are water veins, formed by water, 100% specific to bluestone and are not cracks as people often assume.

<sup>2</sup> Fossils and colour differences: stone is a natural material formed by different perfectly petrified fossils. So it is normal to find nests of crustaceans in the stone.

In other words, even in one sheet of stone clear differences in colour can be observed.

BLUESTONE text is based on a publication by the WTCB (Wetenschappelijk en Technisch Centrum voor het Bouwbedrijf - Building Industry Scientific and Technical Centre)



# Fabrics

## 100% acrylic



- 100% Acrylic fabric
- Developed specifically for outdoor use
- Fibres dyed in the mass, UV-resistant
- Swimming pool and sea water resistant and repellent
- Washable at 40°C (104°F)
- Light fastness: 7-8
- Resistance to pilling: 5
- Resistance to abrasion (Martindale): 12 000

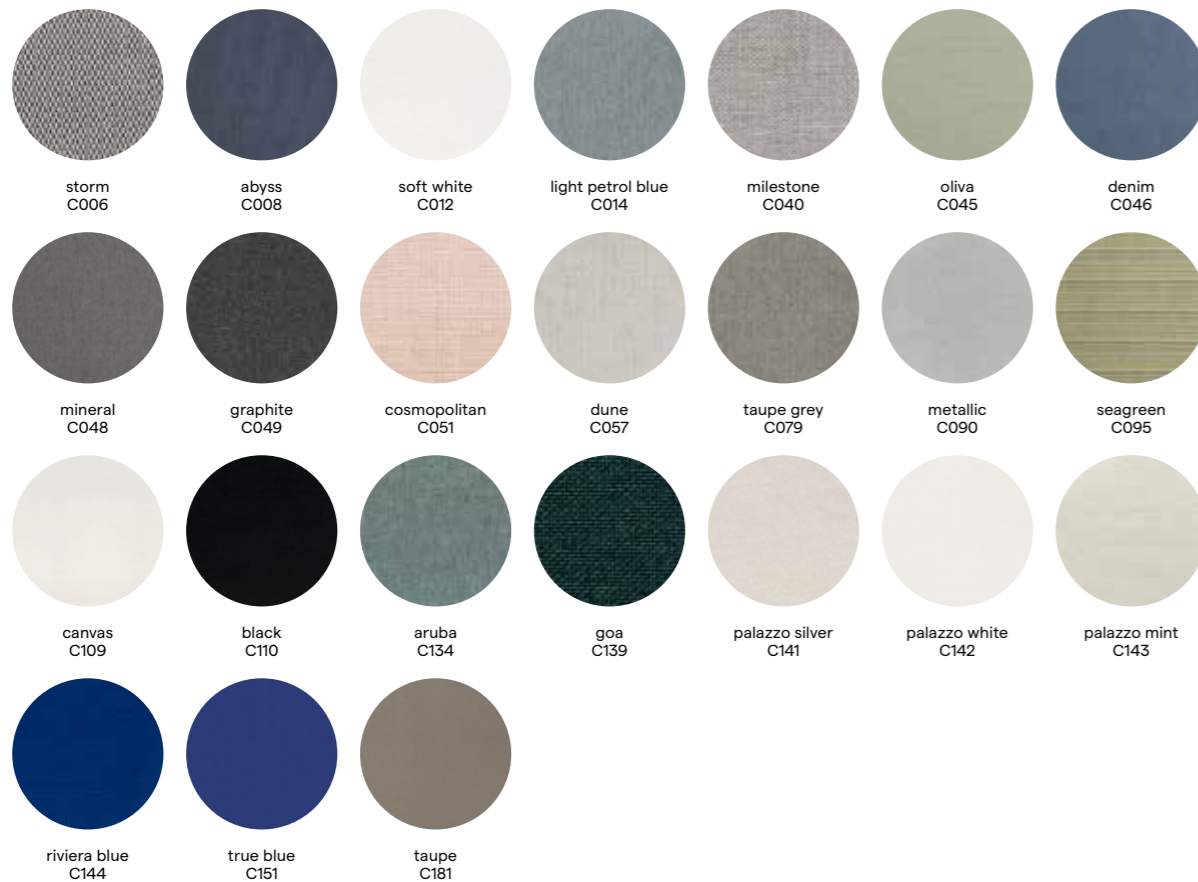

## Polyester / PVC composite



- 100% Polyester / PVC composition
- Developed specifically for outdoor and indoor use
- Dyed in the mass
- Swimming pool and sea water resistant and repellent
- Easy to clean and maintain, for specific maintenance, woven & textile cleaner (see p. 298)
- Light fastness: extreme light stability: > 3 UVA 340/2000 h
- Resistance to abrasion: very high use



## Polyolefin / Polyester



- Fabrics: 60% PP/40% Pes – 82% PP/18 Pes – 99% PP/1% Pes
- Developed specifically for outdoor use
- Fibres dyed in the mass, UV-resistant
- Swimming pool and sea water resistant and repellent
- Washable at 30°C (86°F)
- Light fastness: ≥ 6
- Resistance to pilling: 5
- Resistance to abrasion (Martindale): 30 000
- Recyclable

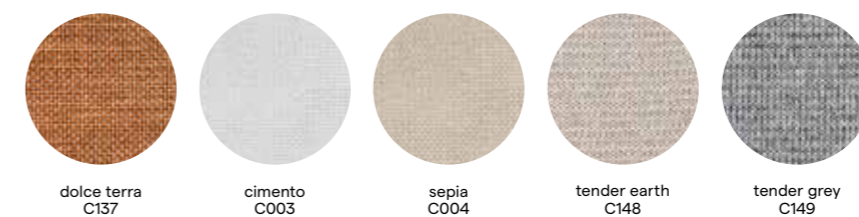



# Fabrics

## 100% Polyolefin



- 100% Polyolefin fabric
- Developed specifically for outdoor use
- Fibres dyed in the mass, UV-resistant
- Swimming pool and sea water resistant and repellent
- Washable at 30°C (86°F)
- Light fastness: 7
- Resistance to pilling: 5
- Resistance to abrasion (Martindale): 15 000
- 100% recyclable

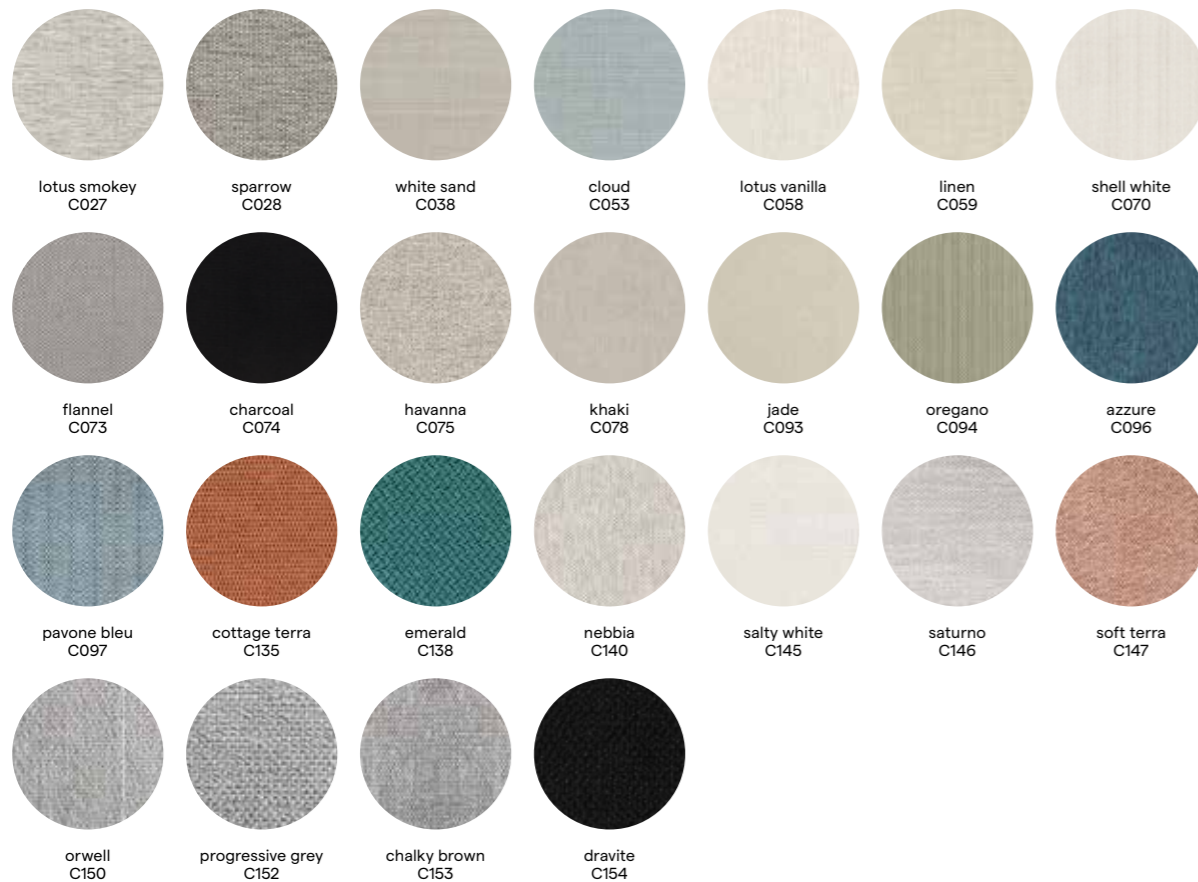

## 88% PVC + 12% Polyester (Artificial leather)



- Artificial leather (leather appearance) with PES fabric + PCV coating
- Developed specifically for outdoor use
- Dyed in the mass, UV-resistant
- Swimming pool and sea water resistant and repellent
- Easy to clean and maintain, use water with a mild soap
- Light fastness: 7-8
- Resistance to abrasion (Martindale): >100 000
- Flame retardent : BS 5852 Source 0 - 1



nautic leather white  
C033

## 98,9% acrylic + 1,1% polyester



- 98,8% acrylic / 1,1% polyester
- Developed specifically for outdoor use
- Swimming pool and sea water resistant and repellent
- Washable at 40°C (104°F)
- Light fastness: 7-8
- Resistance to pilling: 5
- Resistance to abrasion (Martindale): 12 000

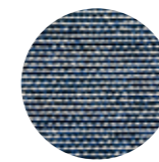

cottage indigo  
C136



# Suggested colour combinations

## Tender Earth

Sit back and relax in the comfort of your outdoor furniture, which combines the natural strength of pepper and bronze ropes, teak and ceramics with warm, earthy tones that blend gently together. Teak and iroko coffee, dining and bar tables are luxuriously appointed: opt for a deep-brown Emperador marble with golden tones for majestic wining and dining or discover the history of a soft brown-grey Fossil ceramic. Trim your lush chairs, loungers and sofas with royal cushions that fuse solid fabrics with subtle structures and muted colours: terracotta, pale red, grey, beiges and brown. Add a touch of emerald green for a bolder look and feel.

TE-GRAPHITE-1

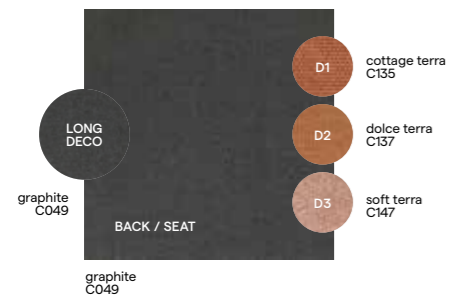

TE-HAVANNA-1

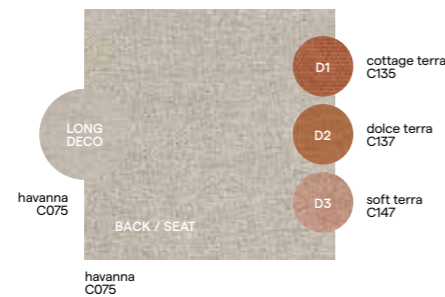

TE-LINEN-1

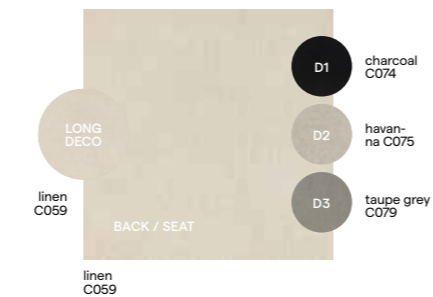

TE-NAUTIC SAND-1

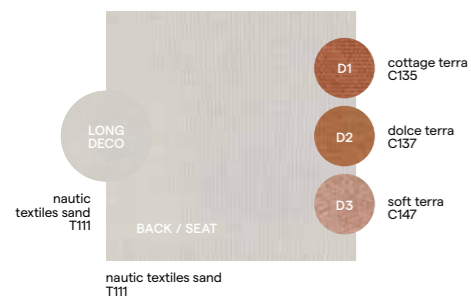

TE-SATURNO-1

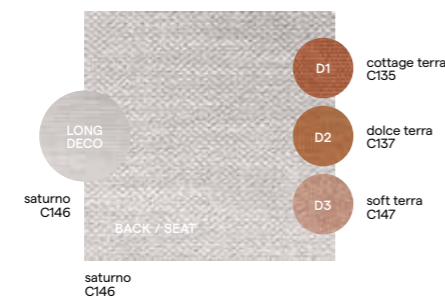

TE-SEPIA-1

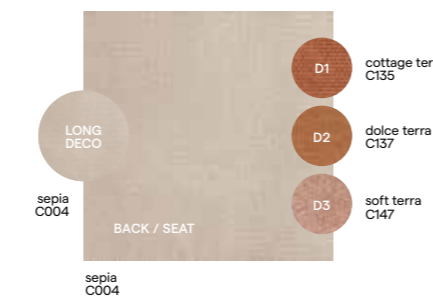

TE-SPARROW-2

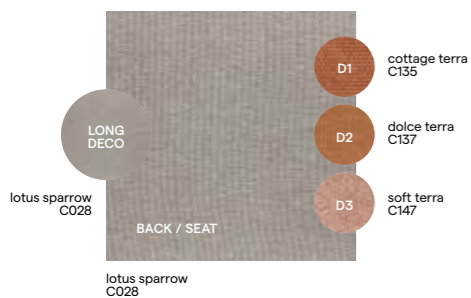

TE-TAUPEGREY-1

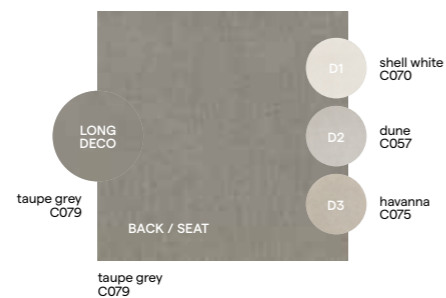

TE-VANILLA-1

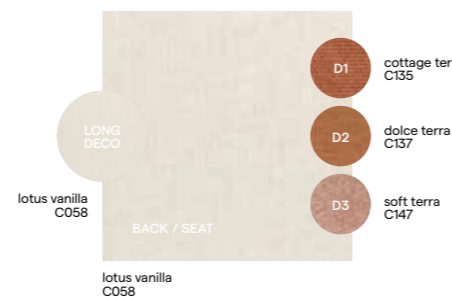

## Tropical concrete

Your urban outdoor furniture combines vigorous natural elements, such as rope, teak and ceramics, with relaxing cooler shades that symbolise the growing synergy between city and nature. Furniture finishing comes in lava, anthracite and brushed teak nero. Swanky sofas, loungers and lounge chairs are matched with cosy cushions in anthracite and blue toned greens. Mix it up with dramatic lighting and trendy rugs and add a touch of warm reddish-brown. Dining tables are topped with basalt black or marble black for a more luxurious look. Or, opt for bright lightness with Perla white ceramics. Feel nothing but majestic!

TC-GRAPHITE-1

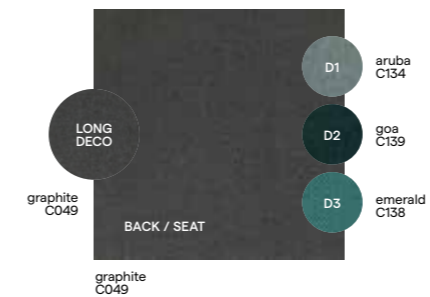

TC-MILESTONE-1

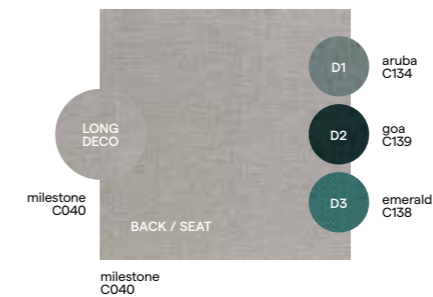

TC-NEBBIA-1

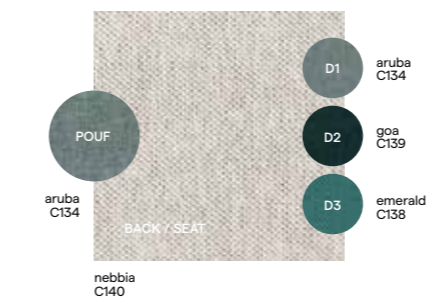

TC-NEBBIA-2

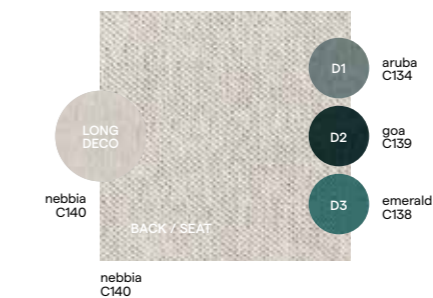



# Suggested colour combinations

## Salty dunes

Inspired by the ocean and the sand, swayed by supple rope, seaborne colours and weathered wood, your outdoor furniture is both modern and timeless. Mix and match a soft flint base with a natural teak tabletop, or spice things up with a sofa solution in pepper. Grey travertine ceramic with brown accents generates a 'ton-sur-ton' effect that blends perfectly with the natural surroundings, while concrete ceramic brings a more contemporary look to your outdoor experience. Recline on sectional sofas, loungers, lounge chairs and poufs, or maintain an elevated position on an elegant bar stool. Decorate your space with sophisticated cushions, rugs and accessories in playful colours. Choose from a palette of silver, white, soft green and yellow shades reminiscent of the dunes, the water and the sparkling sun.

SD-DUNE-2

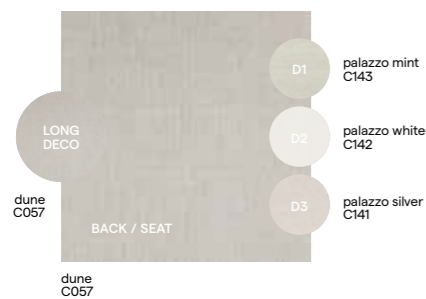

SD-SALTY WHITE-1

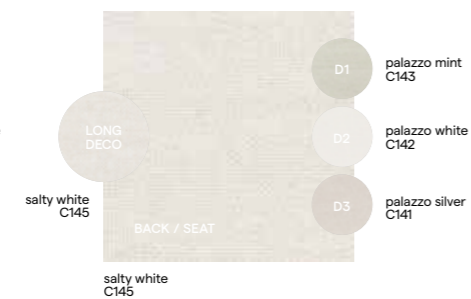

SD-VANILLA-1

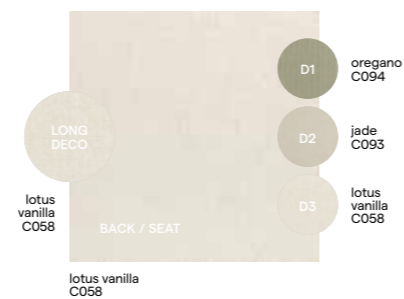

SD-VANILLA-2

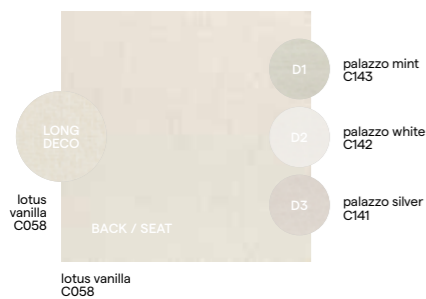

SD-NAUTIC LEATHER WHITE-1



## Crisp water

Characterised by the fusion of robust materials with royal nautical colours, your poolside furniture is sure to inspire and catalyse. Finish off your white frame with silver ropes that match with minimalist surroundings and pearly white, concrete settings. Or, opt for the lava variant and anthracite ropes for a more sophisticated flair. Add a contrasting black teak nero tabletop or choose Carrara white marble for a more diffused effect. Stretch your legs over generous, luxurious poufs, or rest with cool glass in hand on a matching stool. Sofa and lounge chair cushions come in nautical, leather or white varieties. Complete your outdoor pool deck look with stylish accent lighting and blue-tinted accessories. Add a touch of yellow or orange for a more bold look.

CW-ABYSS-1

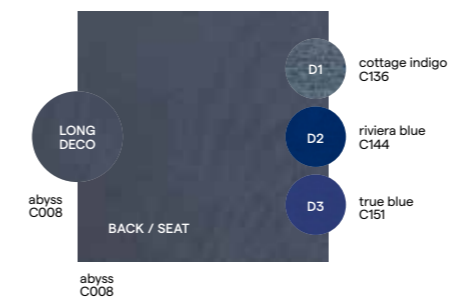

CW-CIMENTO-2

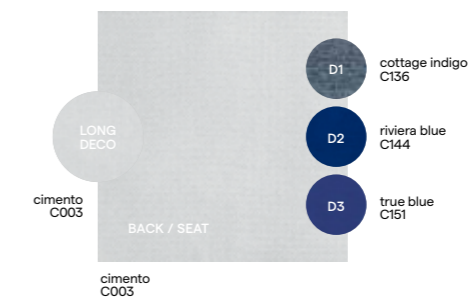

CW-METALLIC-1

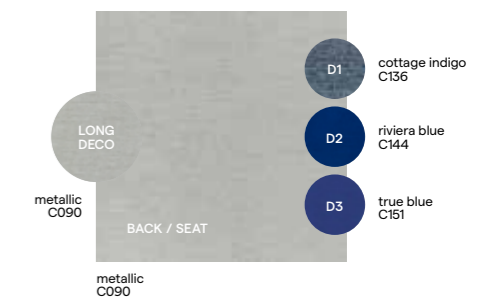

CW-METALLIC-2

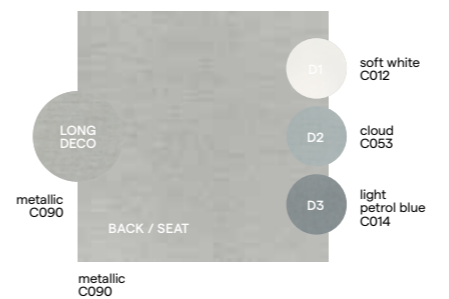

CW-NAUTIC LEATHER WHITE-1



CW-SEPIA-1

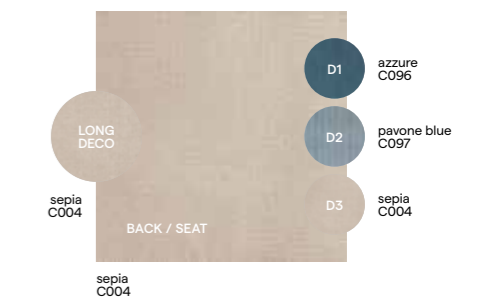

CW-VANILLA-1

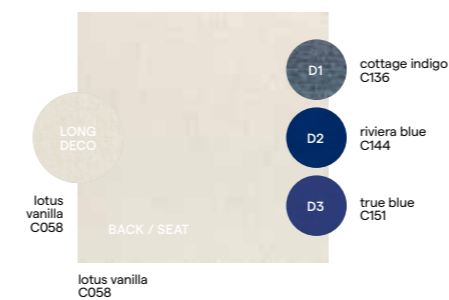

CW-SMOKEY-3

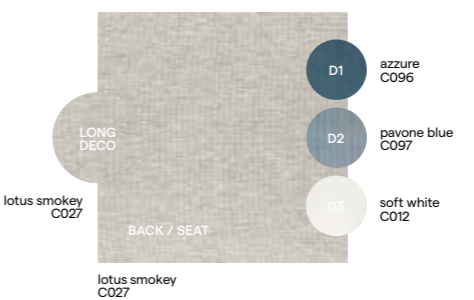





# Protection & maintenance



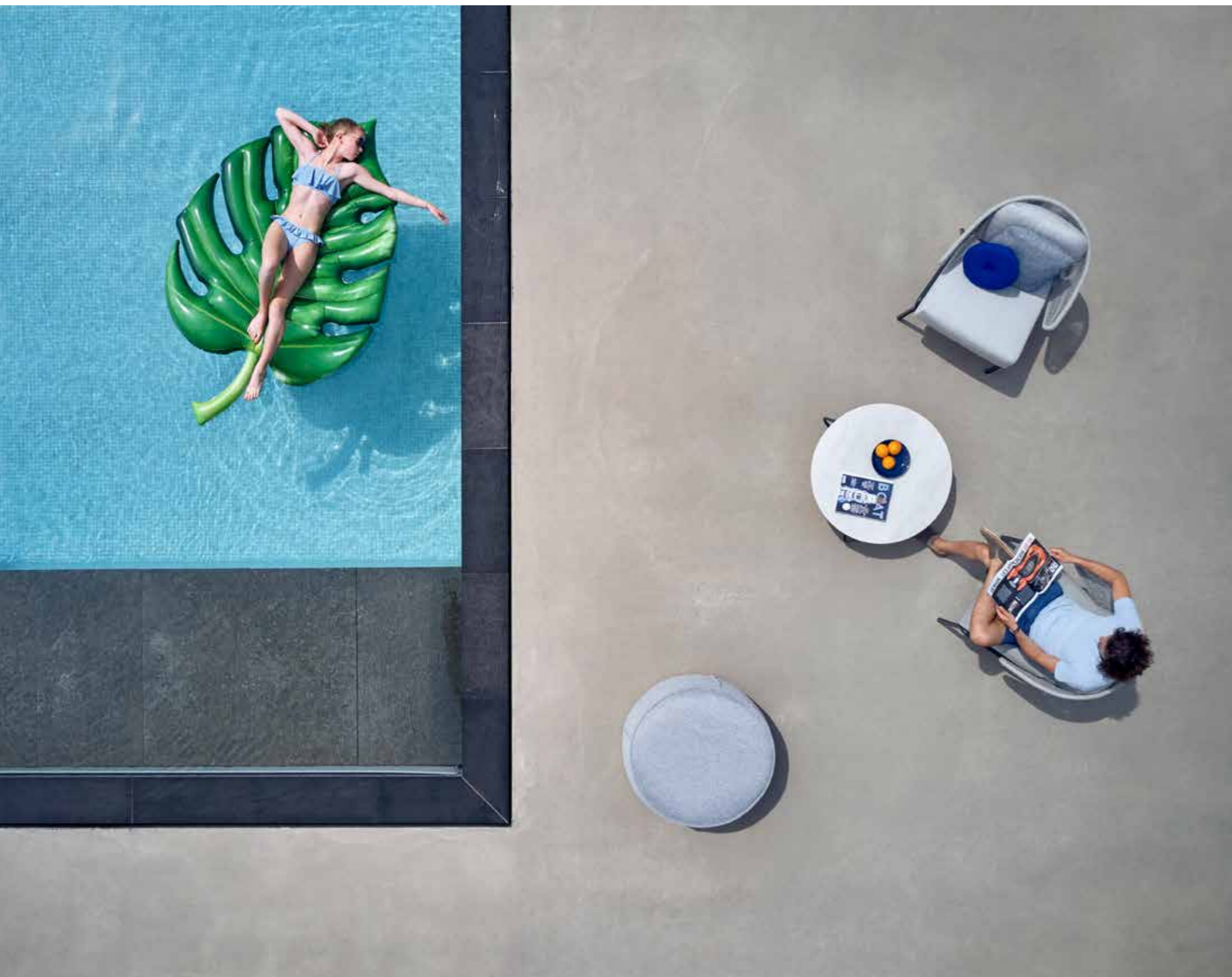

# A lifetime of carefree enjoyment

Each Manutti creation has been manufactured with close attention to the smallest detail. We carefully select the best raw materials and finishings for your outdoor furniture, enabling it to withstand the most capricious weather conditions. To maintain and protect your Manutti pieces, we've developed a series of products that will guarantee their extended lifespan and your carefree enjoyment for many years to come.



# Protective covers

We offer an appropriate cover solution for almost every collection.

Whether you are looking for an easy way to protect your Manutti furniture from poor weather conditions or for an elegant off-season storage solution, our protective covers will do the trick.

Our soft covers offer the best stain- and water-repelling protection. With handy stay-on straps, our close-fitting covers ensure easy placement and maintenance. In addition, their antifungal properties will prevent the mold growth. However, Manutti does not recommend using protective covers for wood tops (aged teak, teak and iroko).

## Polyurethane coated soft covers

- Welded, not stitched seams (no water infiltration possible)
- Mold and fungal resistant
- Breathable fabric





# Furniture

A protective cover is made to fit each separate piece of furniture: it follows the lines of the design so that, even when covered, you still can see the beautiful shape of your Manutti furniture. The protective covers for stackable chairs and 1-seaters fit over 4 stacked pieces.

**Kumo\***  
p. 78



**Elements\***  
p. 82



**Moon Island\***  
p. 102



**Kobo\***  
p. 48



**Cascade\***  
p. 62



**Zendo\***  
p. 90



**Liner\***  
p. 94



**Loop\***  
p. 98



**Duo\***  
p. 72



**Radius\***  
p. 52



**Echo\***  
p. 68



**River\***  
p. 120



**San Diego\***  
p. 128



# Concept

A concept cover is made to order to cover up your chosen Manutti concept in full. An easy-fitting solution.

**Kumo\***  
p. 78



**Elements\***  
p. 82



**Zendo\***  
p. 90



**San Diego\***  
p. 128



**Fuse\***  
p. 140



# Tabletop

Our custom size tabletop covers only cover up the tabletop, not the support of the table nor the chairs you choose to use with the table. Only for Trespa®, acid etched glass and ceramic table tops.



For more information about availability and dimensions, please refer to the pricelist.



# Products

## Aluminium & metal furniture



### Alu & metal protector

Cleaning wax that protects the lacquered aluminium or metal on your Manutti garden furniture.

ref. 10006  
€ 0,5L



### Correction pen for powder coated surfaces

Quick drying liquid paint (liquid, solvent free) for polyester powder coated surfaces. Ideal for retouching and repairing surface marks (impact, scratches, abrasion) on the powdercoating.

ref. COR PCA  
€ 10ml

## Stainless steel furniture



### Stainless steel cleaner & restorer

Cleans stainless steel and restores its original beauty. Makes the surface resistant to dirt and moisture.

ref. 10004  
€ 0,5L



### Stainless steel wax protector

Removes superficial oxidation deposits on stainless steel, and prevents oxidation spots on your furniture.

ref. 10005  
€ 0,5L

## Teak furniture



### Teak cleaner

Cleans greyed teak furniture and restores its clean and sturdy appearance.

ref. 10001  
€ 1L



### Teak stain protector

Saturates teak to make it impenetrable for liquids and dirt.

ref. 10002  
€ 1L



### Teak colour refresher

Maintains the natural, golden brown colour of teak longer and restores greyed teak to its natural colour.

ref. 10003  
€ 1L



### Teak nero corrector

Corrector to maintain and restore the black colour of the Manutti Teak Nero wood.

ref. 10012  
€ 10ml



# Products

## Natural stone



### Stone cleaner

Removes spots on natural stone, from wine to marker pens, and from oil to mould.

ref. 10007  
€ 0,5L



### Stone colour refresher

Restores and deepens the colour of weather-beaten, dark natural stone such as bluestone, granite and satino nero.

ref. 10009  
€ 0,5L



### Stone stain protector

Penetrates natural stone to protect the surface against grease, moisture and dirt. Does not glaze, and allows the stone to continue to breathe. Limited or no discolouration.

ref. 10008  
€ 0,5L



### Grease & oil remover for stone

Removes soaked in spots from natural stone and absorbs impurities from the stone. Subsequent treatment with Manutti Stone Stain Protector is recommended.

ref. 10010  
€ 0,25L

## Glass and Trespa®



### Glass, Trespa® and Silestone® cleaner & polisher

Is ideal for removing all kinds of stains (like light scale and marks due to water residu). Together with the included cloth and thanks to the light sand structure of the cleaner the table top is easy to clean without leaving scratches.

ref. 10011  
€ 0,25L

## Wicker & batyline® furniture



### Woven & textiles cleaner

Cleans braided PVC and batyline used in the woven seats and supports of Manutti garden furniture. Not suitable for textile.

ref. 10000  
€ 0,5L





# Step into our world of outdoor luxury at any moment

Feeling inspired? Experience Manutti for yourself and discover a world beyond your wildest expectations. Bask in the luxury and invitation of our unique design pieces, created with your comfort and pleasure in mind. All that is left for you to do is connect, dream and share experiences.

At Manutti, we don't just design furniture. We design outdoor luxury. Join us outside for a moment of joy at any time of the day, every day: from the cool breeze at dawn and the hot afternoon sun to the sultry embrace of sunset. Make every outdoor moment a Manutti moment.

Discover us online.

 [manutti.com](https://manutti.com)

 [Manutti](#)

 [Manutti\\_official](#)

 [Manutti\\_official](#)





## Copyright

All Manutti designs, names, photos and intellectual property used in this brochure are the copyright of Manutti.

Any infringement or abuse of our copyright will be pursued by law. Manutti always reserves the right to make changes or additions to the descriptions or features given in this brochure in the light of technical developments or availability of materials. We are not responsible for variations in colour, weight or dimensions, as variations are possible whenever products are hand-made.

All Manutti designs are registered trademarks and copyrighted by Manutti. Our trademark is protected by law and all infringements against our trademark and our copyright will be pursued by law.

### **MANUTTI Head office**

Beverenstraat 13-17, 8540 Deerlijk - Belgium

Tel. + 32 56 645 625 - [info@manutti.com](mailto:info@manutti.com)

Design: skinn branding agency

Photography: Isaac Ichou and Luc Roymans



