

# hoyer

barcelona lights

Catálogo General  
*General Catalogue*

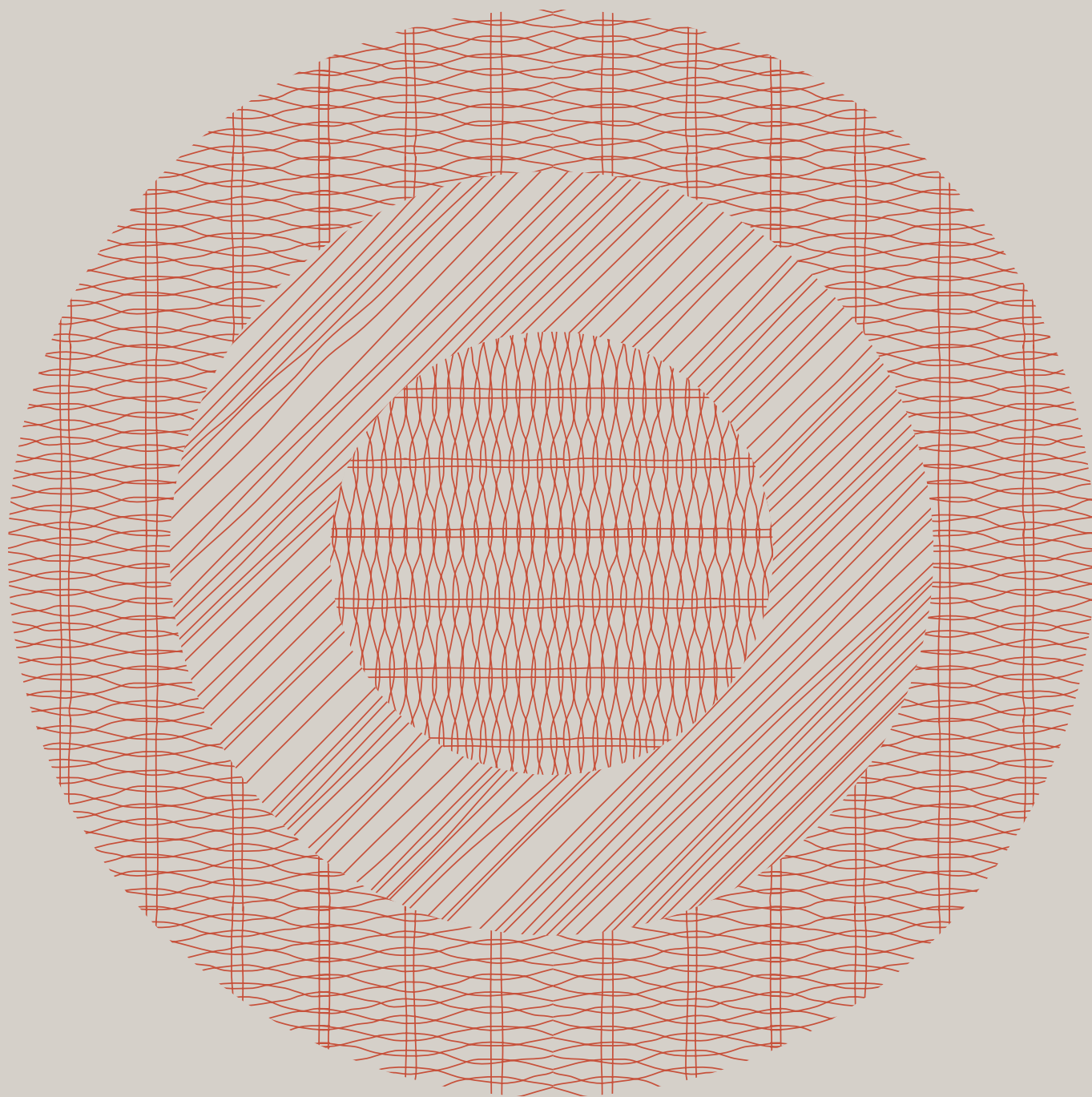

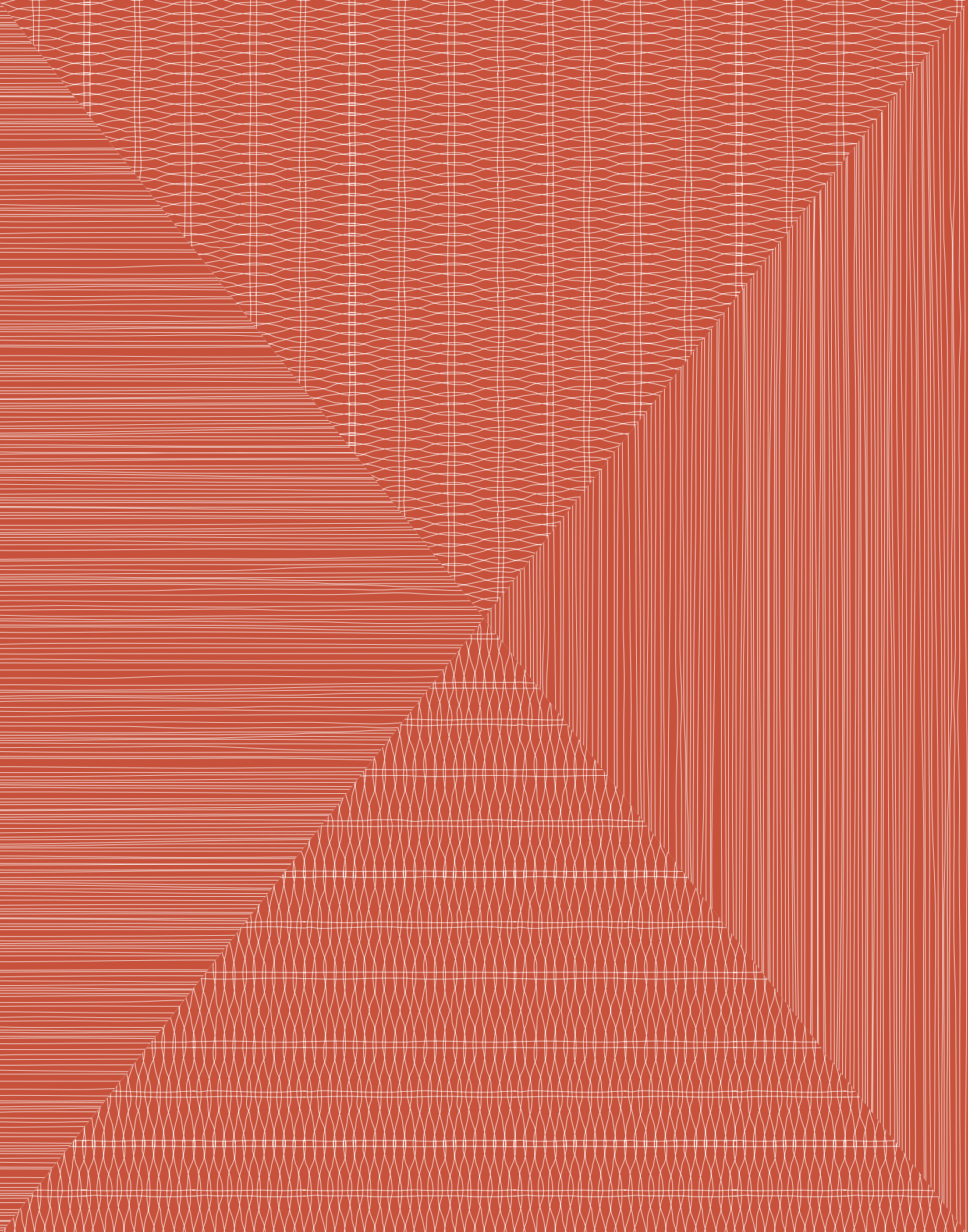

# hover

barcelona lights

Los que vivimos cerca del Mediterráneo conocemos todos los matices de la luz.  
Por eso cuando llega la noche la transformamos en pequeños espacios de día.

Wir, die in der Nähe des Mittelmeers leben, kennen alle Abstufungen des Lichts.  
Wenn die Nacht kommt, verwandeln sie in kleine Punkte des Lichts.

Those of us who live near the Mediterranean know all of light's nuances.  
Therefore when night arrives we transform it into small spaces of day.

Mediterraneotik gertu bizi garenok ondo ezogutzen ditugu argiaren nabardura guztiak.  
Horregatik, goua datorrenean egun bihurtzen dugu gure argi-gune txikien bitartez.

Ceux qui, comme nous, habitent près de la Méditerranée connaissent toutes les nuances de la lumière.  
C'est pourquoi à la nuit tombée, nous la transformons en petits espaces de lumière.

Os que vivimos à beira do Mediterráneo conhecemos todos los matices da luz.  
Por isso ao chegar a noite transformá-mos-la em pequenos espaços do dia.

Noi che viviamo vicino al Mediterraneo conosciamo tutte le sfumature della luce.  
Per questo quando cala la notte, la trasformiamo in piccoli spazi del giorno.

Quem vive perto do Mediterráneo conhece todas as nuances da luz.  
Por isso, quando chega a noite, transformamo-la em pequenos espaços de dia.

Lluís Porqueras





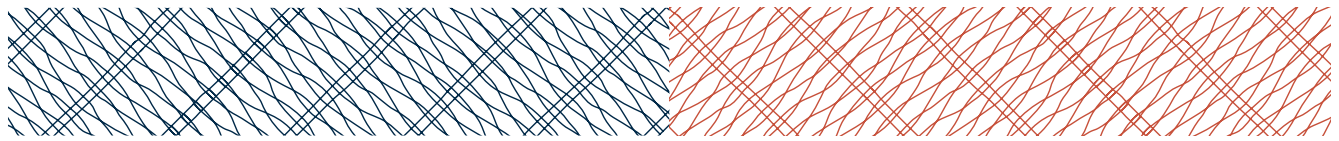

En Bover hace años que trabajamos con la idea de contribuir en la mejora del espacio, intentando resolver de forma natural las necesidades de iluminación que como usuarios consideramos más relevantes.

Nos interesa la búsqueda constante de la intemporalidad como concepto y al mismo tiempo, intentamos mantener el equilibrio entre la tendencia y la cultura material que nos rodea y nos influye. Esa línea suave y discreta que nos separa y nos posiciona frente a los demás, y nos hace sentir diferentes cuando entramos en nuestras casas, en nuestros espacios preferidos. En definitiva, en nuestro mundo.

El contraste, el orden, la belleza, la luz, la cultura que nos alimenta sin darnos cuenta, la elegancia que no se ve, pero se siente; son principios y actitudes que elegimos y que transmiten nuestras ideas, nuestra forma de ver y sentir la vida que nos rodea.

En Bover nos gusta crecer, saber que somos capaces de someternos a numerosas consideraciones que nos ayuden a mejorar nuestro trabajo y, en consecuencia, nuestro entorno.

Entendemos la calidad como una parte fundamental del buen diseño y somos felices, sí, felices, cuando nos damos cuenta de que somos capaces de combinar métodos de producción artesana con tecnologías avanzadas. Nos enorgullece particularmente seguir realizando parte de nuestro trabajo con las manos, porque trabajar de forma artesanal es también una forma de rendir homenaje a la memoria de las cosas que siempre han estado cerca.

Pensar, analizar, diseñar productos que nos devuelven el sabor del tiempo que no pasa y que, convertimos en formas suaves, confortables y orgánicas; nos aporta esa libertad soñada que entiende la belleza como un soplo espontáneo de aire fresco.

Espero que disfrutéis del resultado.

*In Bover we have been working for years with the idea of contributing in the improvement of space; trying to solve the lighting needs in the most natural way that, as users, we consider to be the most relevant.*

*We are interested in the constant search for timelessness as a concept and at the same time, we try to maintain a balance between trends and the material culture that surrounds and influences us. That soft and discreet line that separates and positions us in front of the others and makes us feel different when we enter our homes, our favourite spaces. In short, in our world.*

*The contrast, the order, the beauty, the light, the culture that feeds us without us realising it, the elegance that is not seen, but is felt; are principles and attitudes that we choose and that transmit our ideas, our way of seeing and feeling the life that surrounds us.*

*At Bover we like to grow, we like to know that we are capable of submitting ourselves to numerous considerations that help us to improve our work and, consequently, our environment.*

*We understand quality as a fundamental part of a good design and we are happy, yes, happy, when we realise that we are able to combine artisan methods of production with advanced technologies. We are particularly proud to continue to carry out part of our work manually because working artistically is also a way to pay homage to the memory of things that have always been close.*

*Thinking, analysing, designing products that gives us a sense of being stopped in time and that we become soft, comfortable and organic forms; it brings us that dreamed freedom that understands beauty as a spontaneous breath of fresh air.*

*I hope you enjoy the result.*

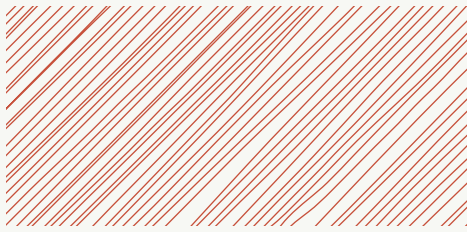

*Diseño Gráfico / Graphic Designer*  
Miquel Llach

*Fotografías / Photographers*  
Jordi Solé / J.E. Estudi Disseny  
Befree Studio

*Agradecimientos / Special Thanks*  
Mireia Sust / Hoteles Vincci  
Hotel Nord 1901 / Girona  
Hostal Empúries / L'Escala  
Fonda Europa / Granollers  
Hotel Villa Emilia / Barcelona  
Restaurant Pasarela / La Roca Village  
Coquinaria / Santa Agnès de Malanyanes  
Hotel SB Europa / Alado Decoració  
Restaurant Llevataps / Girona  
Well & Come / Barcelona  
Ramon Icart / Mas de Vilalba  
Hotel Arrey / Alella  
Hotel Can Cuch / Cànoves  
Tarambana Centre Cultural / Cardedeu  
Granja El Melindro / Cardedeu  
Hotel Barceló Atenea / Barcelona

*Depósito Legal / Legal Deposit:* 18084-09

Octubre 2017



Catálogo  
General

*General  
Catalogue*

## Exterior / Outdoor

---



Alba

18

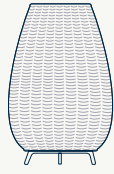

Amphora

22



Atticus

34



Cornet

42



Elipse

54



Fora

58



Garota

80

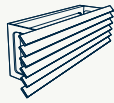

Lineana

98

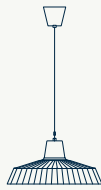

Marietta

106



Maxi

112



Moai

118

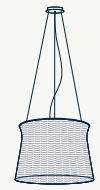

Syra

124

## Interior / Indoor

### Apliques / Wall lamps



Alba

132

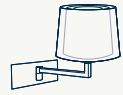

Basik

136

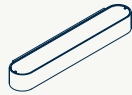

BCN

138



Carlota

148



Drip/Drop

154



Flexo

162



Flexo Lexa

164



Garota

166



Klar

168

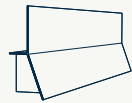

Lea

172

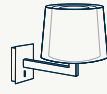

Lexa

178



Lexa FL

182



Liban

186



Nón Lá

188



Oval

196

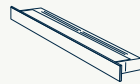

Plana

202

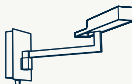

Spock

206



Tria

208

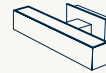

Twall

216

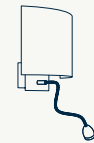

Wall Street

220

### Plafones / Ceiling lamps



Cala

226



Elea

230



Garota

234



Oliver

236

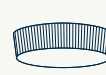

Plafonet

238



Siam

242



Urban

252

## Interior / Indoor

### Suspensión / Pendant lamps

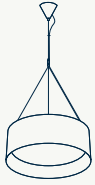

Cala  
258

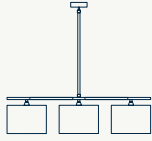

Danona  
262

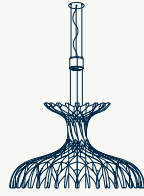

Dome  
266

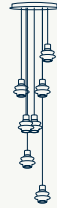

Drip/Drop  
276

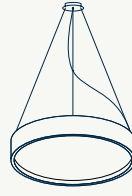

Elea  
298



Elipse  
304

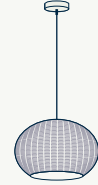

Garota  
306



Hardy  
308

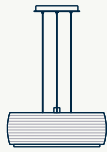

Inari  
312

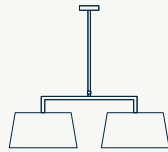

Lua  
316

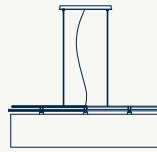

Mar  
320



Marietta  
324



Maxi  
332



Mei  
338

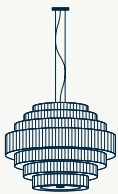

Mos  
348

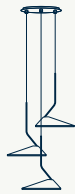

Nón Lá  
352



Oliver  
360

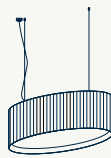

Oval  
364



Penta  
366

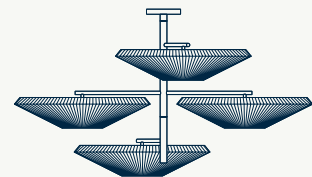

Siam  
372



Slend  
378



Syra  
386



Tibeta  
390

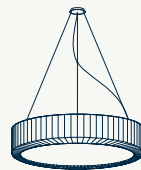

Urban  
398

---

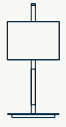
 Mesa / Table lamps

Danona  
402



Drip/Drop  
404



Ema  
412



Garota  
414

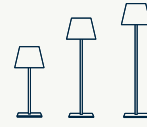

Gibsi  
416



Inari  
418

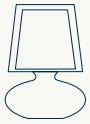

Muf  
420



Nón Lá  
424



Oval  
426



Penta  
430



Spock  
432



Tau  
436

---

 Pie / Floor lamps

Danona  
440



Drip/Drop  
442



Ema  
446



Inari  
448



Maxi  
450



Oval  
452



Penta  
454



Spock  
456

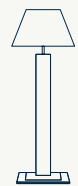

Tau  
458



Alex Fernández Camps

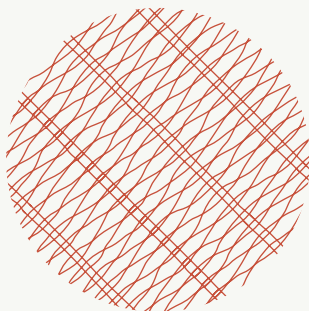

Carles Riart

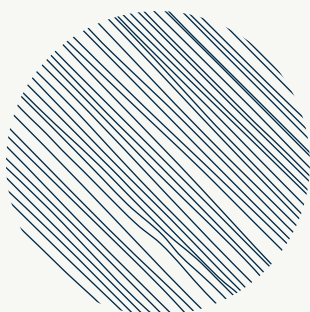

Gonzalo Milà

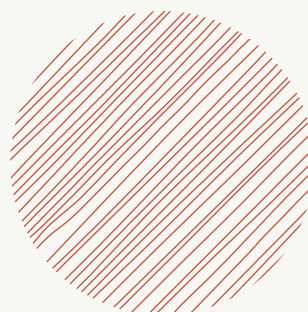

Jordi Llopis

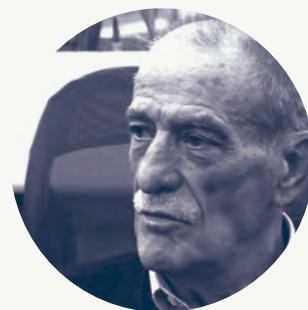
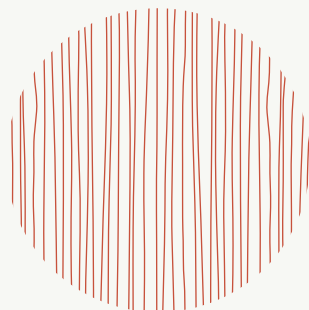

Lluís Porqueras

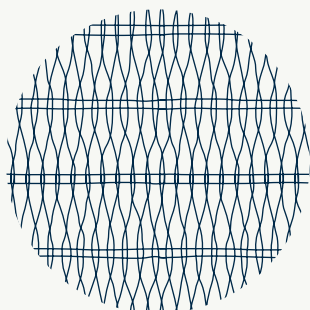

Rubén Saldaña

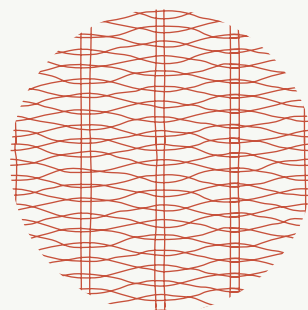

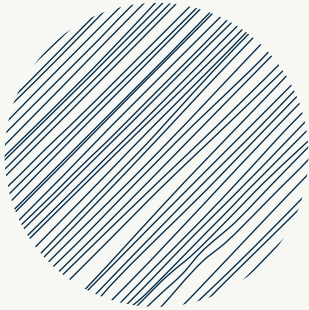

Benedetta Tagliabue EMBT

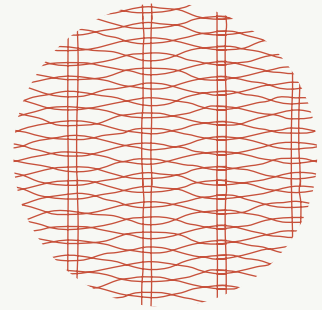

Christophe Mathieu

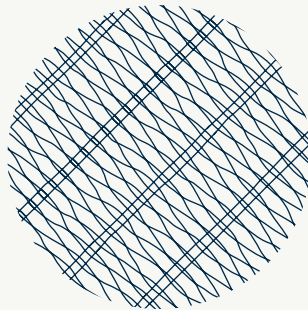

Joana Bover

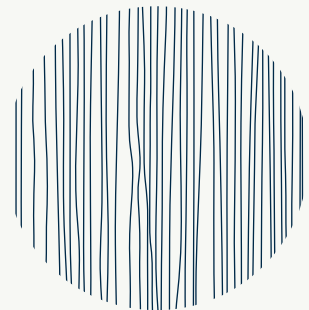

Jorge Pensi Design Studio

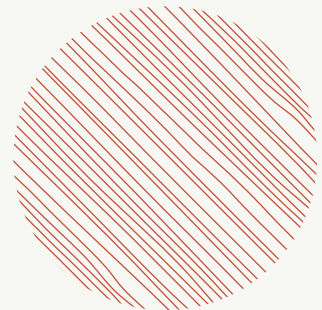

Juan Carlos Ines

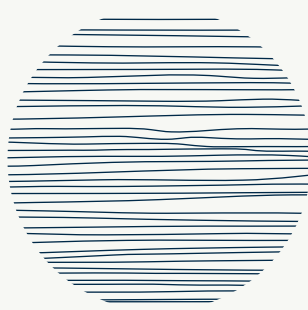

Sergi & Óscar Devesa

# Outdoor





Quizás porque somos del mediterráneo; el outdoor es uno de los campos en los que Bover es más conocida.

El denominador común de esta colección es la combinación de resistencia y sensibilidad. Resistencia ya que está diseñada para poder vivir cómodamente a la intemperie, y sensibilidad expresada en la delicadeza con que tamiza la luz y la calidez general de la lámpara. Estas características hacen que tanto dentro como fuera de un espacio arquitectónico, ayuden a crear una sensación de continuidad.

*Perhaps because we are from the Mediterranean; the outdoors are one of the areas in which Bover is best known.*

*This collection's common denominator is the combination of resistance and sensitivity. Resistance since it is designed to be able to live comfortably outdoors, and sensitivity expressed in the delicacy with which it sifts the light and the general warmth of the lamp. These features mean that both the inside and outside of an architectural space help to create a sense of continuity.*

# Alba

by Rubén Saldaña | 2014

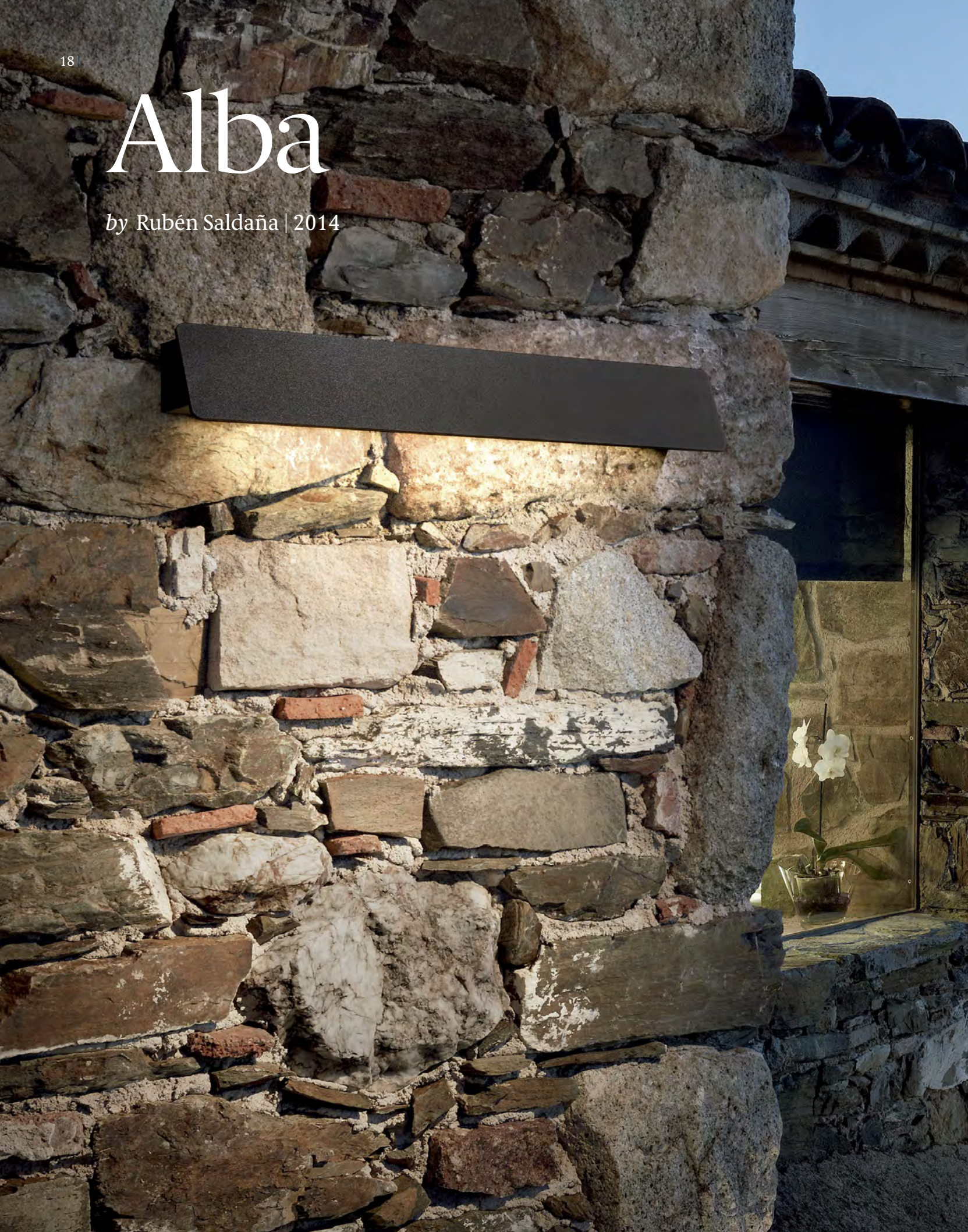



“Alba es un aplique de diseño arquitectural; especialmente indicado para iluminar elementos que requieran una luz directa y uniforme.”

*“Alba is an architectural design wall sconce especially suitable to project light over elements requiring direct and uniform illumination.”*





### Alba 60 Outdoor

Aplique Exterior  
Outdoor Wall Lamp

⏏ | ⚡ | IP 65 | 230V | 50Hz



⦿ 11,5 W LED / 28 x 0,41 W = 11,5 W | 1060 lm / CRI: 90 / 3000° K

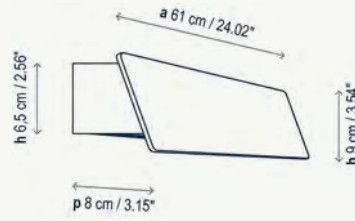

2270100614 Marrón Grafito  
Graphite Brown

### Alba 90 Outdoor

Aplique Exterior  
Outdoor Wall Lamp

⏏ | ⚡ | IP 65 | 230V | 50Hz



⦿ 17 W LED / 2 x 0,41 W = 17 W | 1600 lm / CRI: 90 / 3000° K

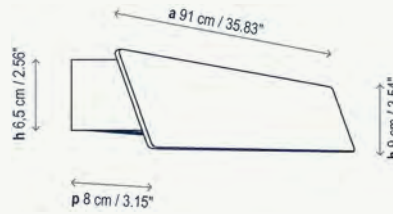

2270200614 Marrón Grafito  
Graphite Brown

#### Materials / Materials

Acero Inoxidable - Aluminio  
Stainless steel - Aluminum

#### Familia / Family

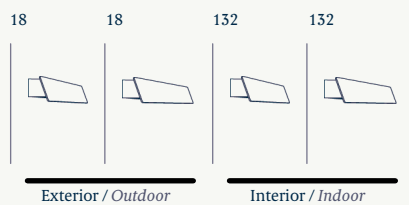

#### Acabados / Finishing



Marrón Grafito  
Graphite Brown

# Amphora

by Alex Fernández Camps / Gonzalo Milà | 2013

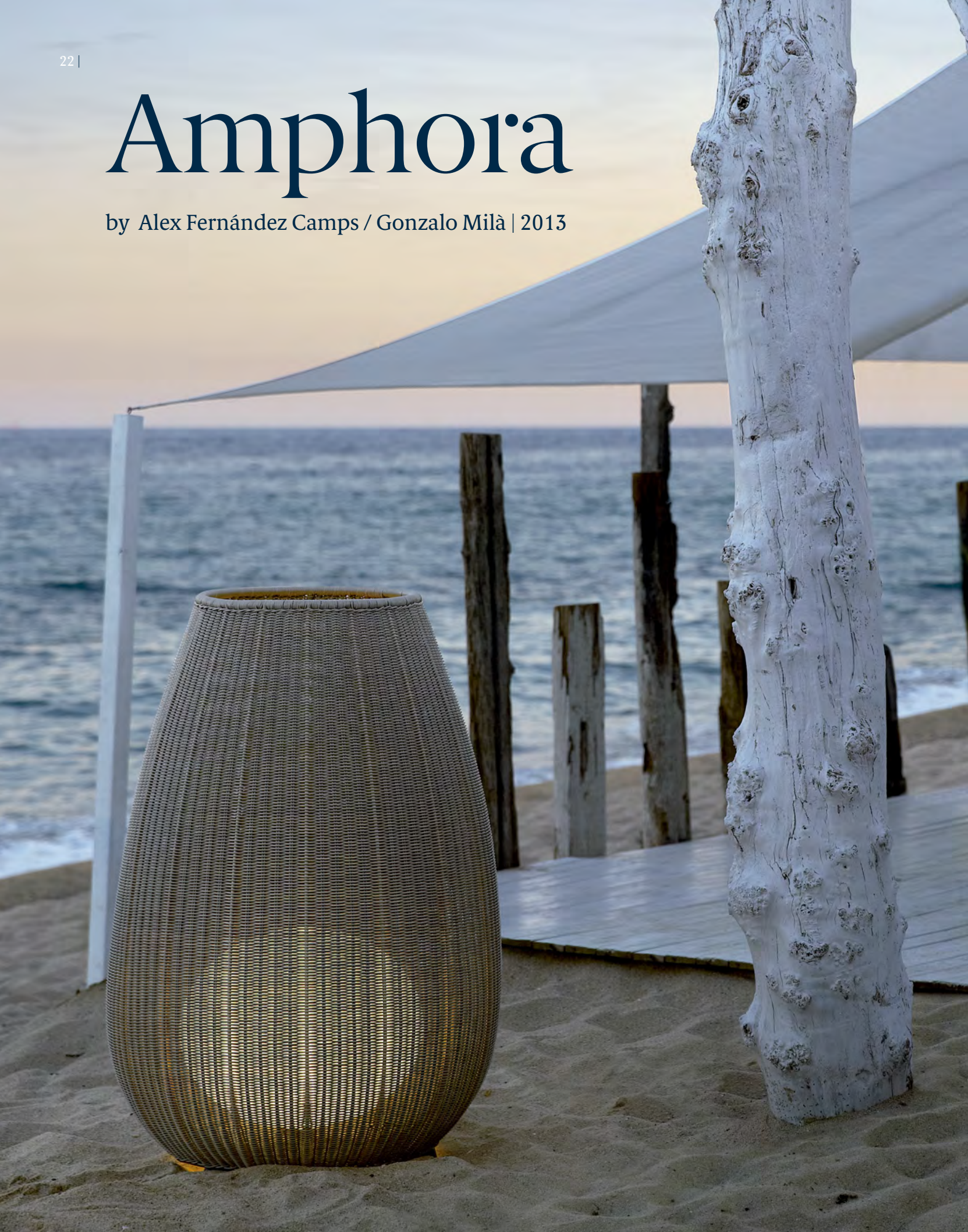

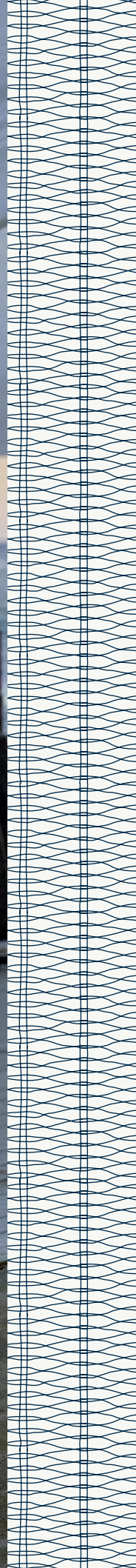

“Sus grandes volúmenes y formas rinden un sutil y discreto homenaje a las ánforas de terracota que antiguamente se utilizaban para almacenar alimentos.”

*“The size and shape of this collection pay a subtle and discreet homage to the terracotta amphora formerly used for to store food”.*





Las Amphora son lámparas pensadas para crear ambientes cálidos en espacios de exterior; aunque su carácter altamente decorativo también las hace perfectas para interior.

En este caso hemos utilizado la fibra sintética para la confección artesanal de sus grandes cestos de fibra, pantallas que se apoyan sobre un trípode de fundición de aluminio con tratamiento antioxidante. La fuente de luz se encuentra en el interior de una elipse de polietileno que garantiza su estanqueidad. La luz que emite esta luminaria es rica en matices.

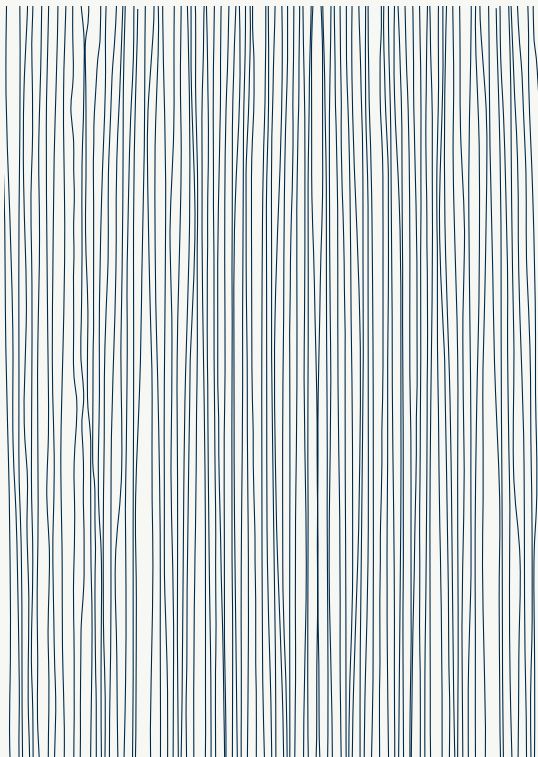

*The Amphora collection has been designed to create a warm environment especially in outdoors. However, thanks to its highly decorative look, the Amphoras can equally be placed both in outdoor and indoor.*

*In this collection we have used a synthetic wicker to make up big handmade baskets as shades with a aluminum tripod foot subjected to a cataphoresis treatment. The light source is located inside the polyethylene ellipse which grants its water proofing. The light emitted by the Amphora collection is full of nuances.*









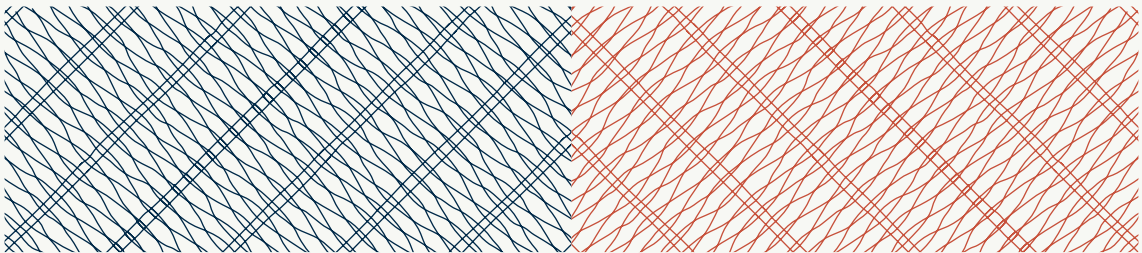











## Amphora 01

Pie Exterior / Outdoor Floor



 IP 65 | 230V  
50Hz



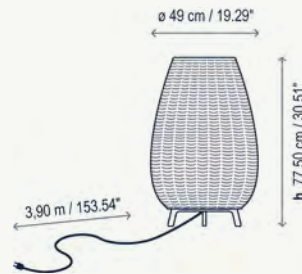

 2 x 22 W E-27

 2 x 9 W LED E-27 A60



0133003/P741 Estructura Marrón Grafito  
Pantalla Beige Claro  
*Structure Graphite Brown  
Light Beige Shade*

0133003/P742 Estructura Marrón Grafito  
Pantalla Marrón Rattan  
*Structure Graphite Brown  
Rattan Brown Shade*

## Amphora 02

Pie Exterior / Outdoor Floor



 IP 65 | 230V  
50Hz





 2 x 30 W E-27

 2 x 9 W LED E-27 A60

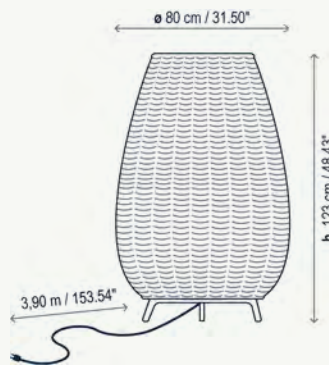

0233003/P744 Estructura Marrón Grafito  
Pantalla Beige Claro  
*Structure Graphite Brown  
Light Beige Shade*

0233003/P745 Estructura Marrón Grafito  
Pantalla Marrón Rattan  
*Structure Graphite Brown  
Rattan Brown Shade*

## Amphora 03

Pie Exterior / Outdoor Floor



 IP 65 | 230V  
50Hz





 2 x 30 W E-27

 2 x 9 W LED E-27 A60

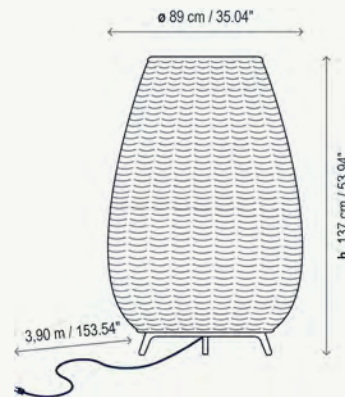

0333003/P747 Estructura Marrón Grafito  
Pantalla Beige Claro  
*Structure Graphite Brown  
Light Beige Shade*

0333003/P748 Estructura Marrón Grafito  
Pantalla Marrón Rattan  
*Structure Graphite Brown  
Rattan Brown Shade*

Consulte las opciones de anclaje al suelo  
*Consult for floor fastening options.*

### Materiales / Materials

Aluminio - Acero inoxidable - Polietileno - Fibra sintética  
*Aluminum - Stainless steel - Polyethylene - Synthetic fiber*

Todas las fibras sintéticas utilizadas por Bover son reciclables y no tóxicas para la sostenibilidad del medio ambiente

*All synthetic fibers used by Bover are recyclable and non-toxic for environmental sustainability.*

### Acabados / Finishing



Marrón Grafito  
*Graphite Brown*

Beige Claro  
*Light Beige*

Marrón Rattan  
*Rattan Brown*

# Atticus

by Joana Bover | 2017

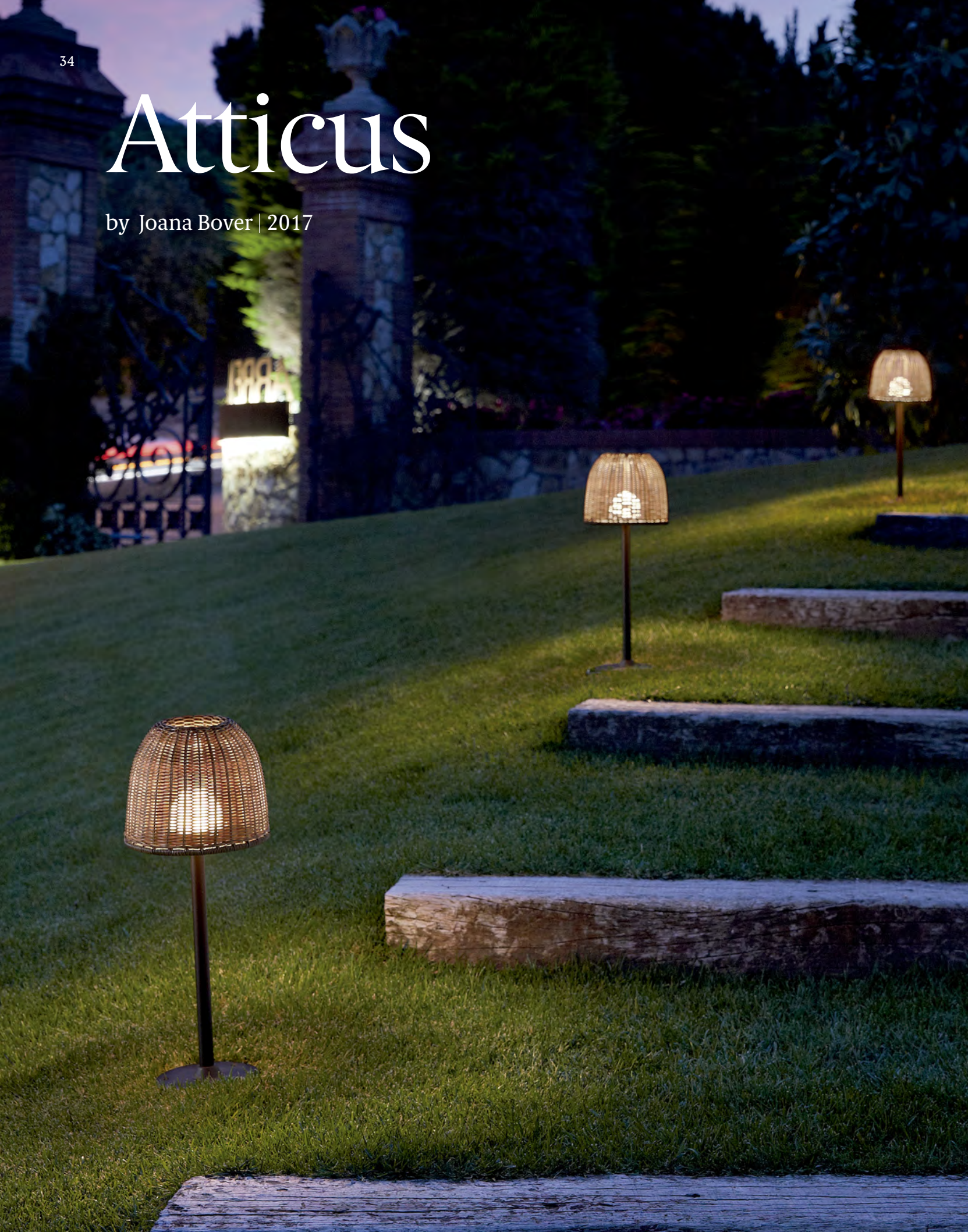



“Hay que estar bien. Estés donde estés, pero bien. Atticus es una lámpara que acoge y acompaña”.

*“We must feel good. Wherever we are, really good. Atticus is a lamp that welcomes and accompanies”.*





## Atticus B/56 - B/66

Baliza Exterior / Outdoor Bollard

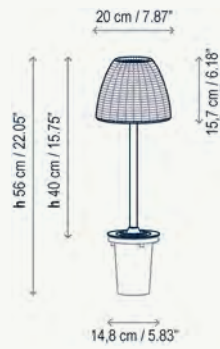

Atticus B/56

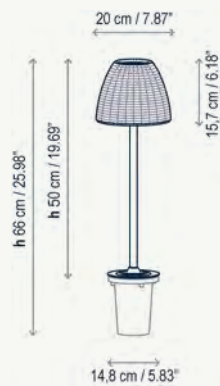

Atticus B/66

### Atticus B/56

- 3100440001 Blanco Roto  
Pantalla Blanca Marfil  
*Natural White*  
*Ivory White Shade*
- 3100440040 Blanco Roto  
Pantalla Beige Claro  
*Natural White*  
*Light Beige Shade*
- 3100440003 Marrón Grafito  
Pantalla Marrón  
*Graphite Brown*  
*Brown Shade*

### Atticus B/66

- 3100540001 Blanco Roto  
Pantalla Blanca Marfil  
*Natural White*  
*Ivory White Shade*
- 3100540040 Blanco Roto  
Pantalla Beige Claro  
*Natural White*  
*Light Beige Shade*
- 3100540003 Marrón Grafito  
Pantalla Marrón  
*Graphite Brown*  
*Brown Shade*

Sistema de regulación TRIAC sin interruptor  
*TRIAC dimming system without switch*

No Incluyen tacos de sujeción a superficie  
*Does not include clamping lugs to surface*

### Materiales / Materials

Aluminio - Acero inoxidable 316 - Latón - Polietileno - Fibra sintética  
*Aluminum - 316 Stainless steel - Brass - Polyethylene - Synthetic fiber*

Todas las fibras sintéticas utilizadas por Bover son reciclables y no tóxicas para la sostenibilidad del medio ambiente

*All synthetic fibers used by Bover are recyclable and non-toxic for environmental sustainability.*

### Acabados / Finishing



Blanco Roto  
*Natural White*

Marrón Grafito  
*Graphite Brown*

Blanco Marfil  
*Ivory White*

Beige Claro  
*Light Beige*

Marrón  
*Brown*









## Atticus P/114/R

Pie Exterior con Bateria  
Outdoor Floor with Battery

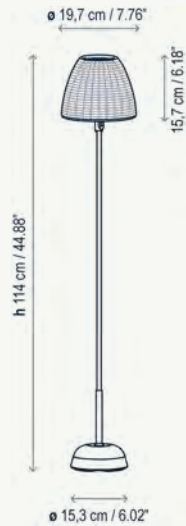

- 3100130901 Blanco Roto - Pantalla Blanco Marfil  
*Natural White - Ivory White Shade*
- 3100130940 Blanco Roto - Pantalla Beige Claro  
*Natural White - Light Beige Shade*
- 3100130903 Marrón Grafito - Pantalla Marrón  
*Graphite Brown - Brown Shade*

Interruptor On-Off, Operativa 50% 100%  
*On-Off Switch, Operation 50% 100%*

Tiempo de carga: +/- 5:30 Horas  
*Battery Charging Time: +/- 5:30 Hours*

Duración batería al 100%: +/- 5 Horas  
*Battery Duration Time 100%: +/- 5 Hours*

Duración batería al 50%: +/- 11 Horas  
*Battery Duration Time 50%: +/- 11 Hours*

Cargador sw batería incluido / *Battery Charger included*

## Atticus P/114

Pie Exterior  
Outdoor Floor



Con interruptor  
*With switch*

Sin interruptor  
*Without switch*

- 3100230201 Blanco Roto - Pantalla Blanco Marfil  
Con Interruptor  
*Natural White - Ivory White Shade  
With Switch*
- 3100230240 Blanco Roto - Pantalla Beige Claro  
Con Interruptor  
*Natural White - Light Beige Shade  
With Switch*
- 3100230203 Marrón Grafito - Pantalla Marrón  
Con Interruptor  
*Graphite Brown - Brown Shade  
With Switch*

Interruptor On-Off debajo de la base  
*On-Off switch under the base*

- 3100330101 Sin Interruptor  
Blanco Roto - Pantalla Blanco Marfil  
*Without Switch  
Natural White - Ivory White Shade*

- 3100330140 Sin Interruptor  
Blanco Roto - Pantalla Beige Claro  
*Without Switch  
Natural White - Light Beige Shade*

- 3100330103 Sin Interruptor  
Marrón Grafito - Pantalla Marrón  
*Without Switch TRIAC  
Graphite Brown - Brown Shade*

Sujeción al suelo opcional / *Optional ground fastening*

### Materiales / Materials

Aluminio - Acero inoxidable 316 - Latón - Polietileno - Fibra sintética  
*Aluminum - 316 Stainless steel - Brass - Polyethylene - Synthetic fiber*

### Acabados / Finishing



# Cornet

by Alex Fernández Camps | 2017





“Cornet es un proyecto con alto contenido técnico y lleno de vida. Sus líneas armónicas y orgánicas consiguen mimetizarse con la naturaleza donde no existen líneas rectas.”

*“Cornet is a highly technical project, yet full of life. Its form is harmonious, organic and it blends in with nature where there are no straight lines.”*

















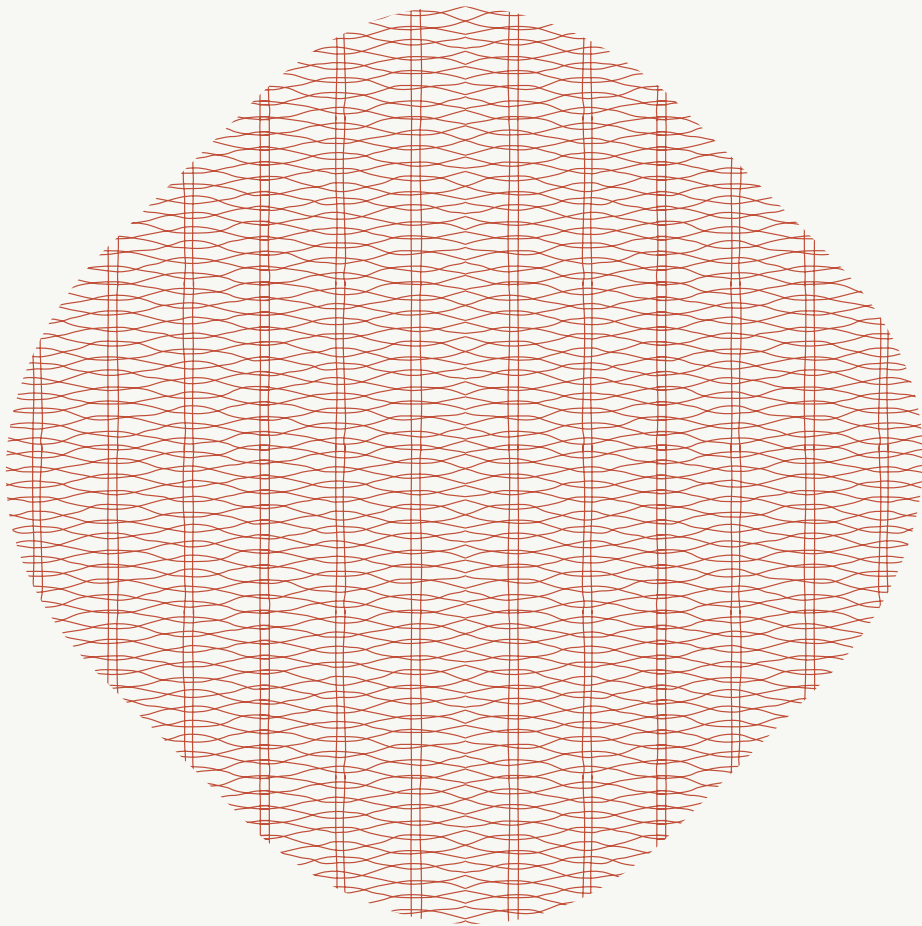





## Cornet A/01

Aplique Exterior / Outdoor Wall Lamp

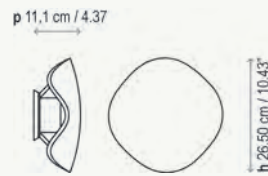

3400101227 Dimable TRIAC - Gris Piedra  
Dimmable TRIAC - Stone Grey

## Cornet B/27

Baliza Exterior / Outdoor Bollard

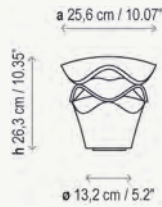

3400240027 Dimable TRIAC - Gris Piedra  
Dimmable TRIAC - Stone Grey

No Incluyen tacos de sujeción a superficie / Does not include clamping lugs to surface

## Cornet B/52

Baliza Exterior / Outdoor Bollard

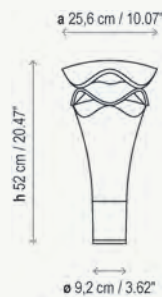

3400340027 Dimable TRIAC - Gris Piedra  
Dimmable TRIAC - Stone Grey

Baliza con dos opciones de sujeción:  
Two anchoring options for bollards:

- Fijación a suelo, tornillería y tacos de sujeción no incluidos.  
Anchoring to ground, screws and anchors accessories not included.
- Fijación por cimentación, accesorio de anclaje no incluido.  
Anchoring for foundation, fasteners accessories not included.

## Cornet B/77

Baliza Exterior / Outdoor Bollard

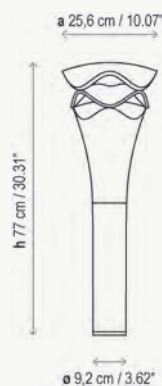

3400440027 Dimable TRIAC - Gris Piedra  
Dimmable TRIAC - Stone Grey

Baliza con dos opciones de sujeción:  
Two anchoring options for bollards:

- Fijación a suelo, tornillería y tacos de sujeción no incluidos.  
Anchoring to ground, screws and anchors accessories not included.
- Fijación por cimentación, accesorio de anclaje no incluido.  
Anchoring for foundation, fasteners accessories not included.

## Materiales / Materials

Poliuretano - Acero inoxidable 316  
Polyurethane - 316 Stainless steel

## Acabados / Finishing



Gris Piedra  
Stone Grey

# Eclipse outdoor

by Alex Fernández Camps / Gonzalo Milà | 2017



Elipse outdoor es una solución sencilla, libre y flexible en su aplicación. Puede actuar de sobremesa colgada de una rama durante una cena, iluminar un rincón de un jardín junto a una hamaca, o crear una atmósfera mágica con un conjunto de Elipses suspendidas en la noche. La belleza de la sencillez.

*Elipse outdoor is a simple, free and flexible solution on its application. It can be used for a table top hanging from a branch during a dinner, to light a corner of a garden next to a hammock, or create a magical atmosphere with a set of ellipses suspended at night. The beauty of simplicity.*







### Elipse PF/30 - PF/50 Outdoor

Plafón Exterior  
Outdoor Ceiling Lamp

-   IP 65 | 230V 50Hz
-  
-  2 x 14 W E-27
-  2 x 6 W LED E-27 A60

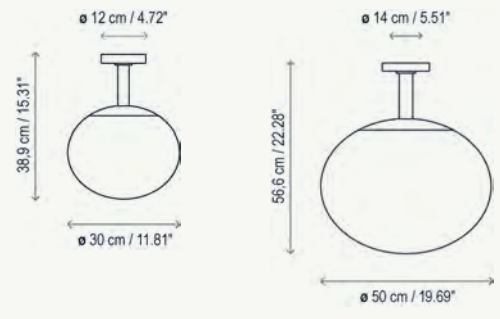

- 3230110013 Bola 30 - Blanco  
Ball 30 - White
- 3230210013 Bola 50 - Blanco  
Ball 50 - White

### Elipse S/30 - S/50 Outdoor

Suspensión Exterior  
Outdoor Pendant Lamp

-   IP 65 | 230V 50Hz
-  
-  2 x 14 W E-27
-  2 x 6 W LED E-27 A60

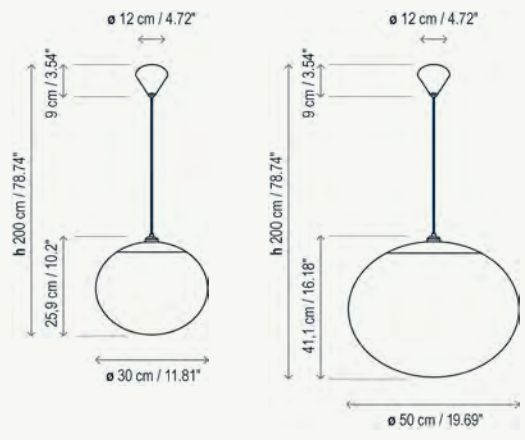

- 3230120213 Bola 30 - Blanco  
Ball 30 - White
- 3230220213 Bola 50 - Blanco  
Ball 50 - White

### Elipse S/30/H - S/50/H Outdoor

Suspensión Exterior  
Outdoor Pendant Lamp

-   IP 65 | 230V 50Hz
-  
-  2 x 14 W E-27
-  2 x 6 W LED E-27 A60

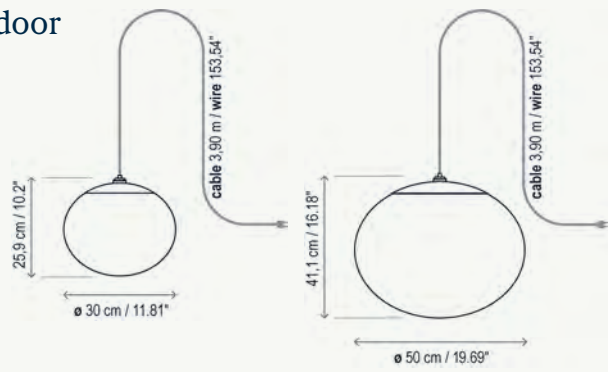

- 3231120213 Bola 30 - Blanco  
Ball 30 - White
- 3231220213 Bola 50 - Blanco  
Ball 50 - White

Esta luminaria no contiene interruptor.  
This luminaire does not include a switch.

Longitud total del cable: 4 metros  
Total cable length: 157.48 inches.

#### Familia / Family

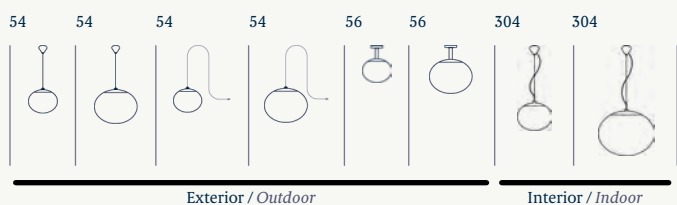

#### Materiales / Materials

Poliétileno de media densidad  
Medium density polyethylene

#### Acabados / Finishing



# Fora

by Alex Fernández Camps / Gonzalo Milà | 2010



“Un globo generoso, suspendido en una pantalla tejida con la técnica tradicional del mimbre; nos da luz eficiente en la proximidad y una luz general tamizada y agradable”.

*“A generous globe, suspended within a woven outer shade with the traditional wicker technique is efficiently illuminating the area with a general and pleasant light.”*



Fora está técnicamente preparada para ser instalada en exteriores, pero la calidez del objeto permite colocarlo también en interiores.

La versión de pie tiene una solución que nos gusta porque respeta la vida vegetal del suelo al permitir que llegue el máximo de luz, agua y aire posibles. La pantalla de fibra sintética de Fora es altamente resistente a los efectos climatológicos; a la vez que aporta una agradable atmósfera de luz difusa o envolvente.

Fora is technically ready to be installed outdoors, but its warmth allows it to be placed indoors as well.

The floor version has a solution that we like because it respects the soil's plant life by allowing as much light, water and air as possible. The Fora synthetic fiber shade is highly resistant to weather, while at the same time providing a pleasant atmosphere of diffused and enveloping light.



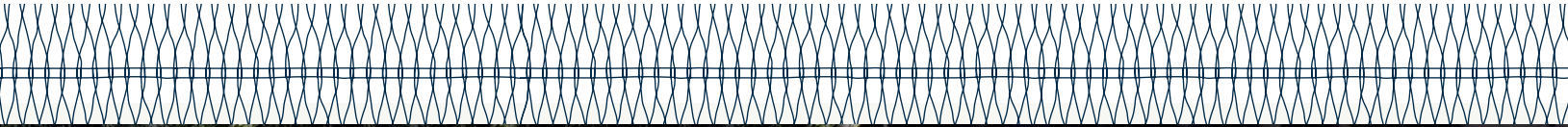

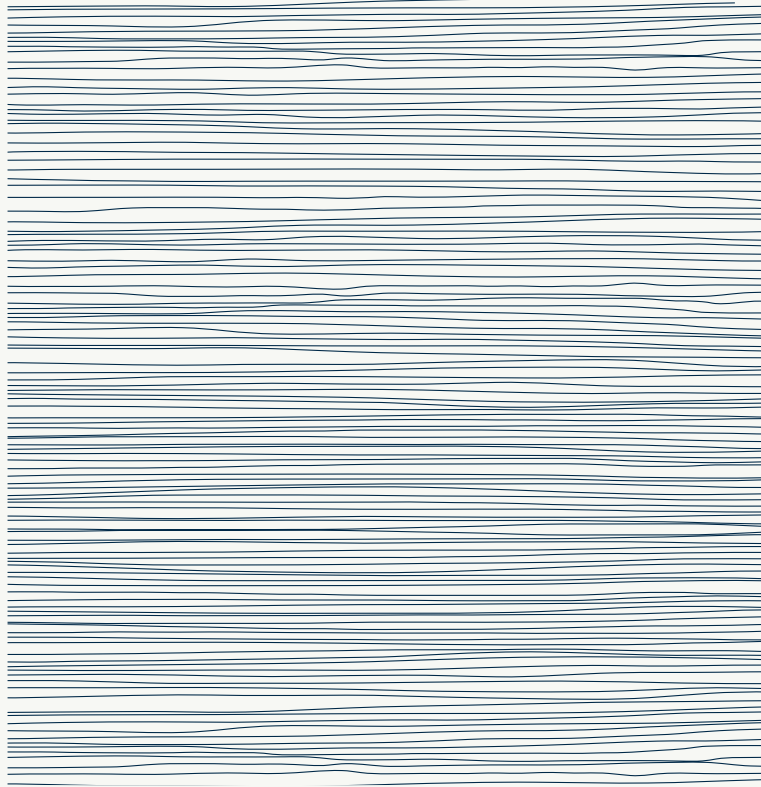



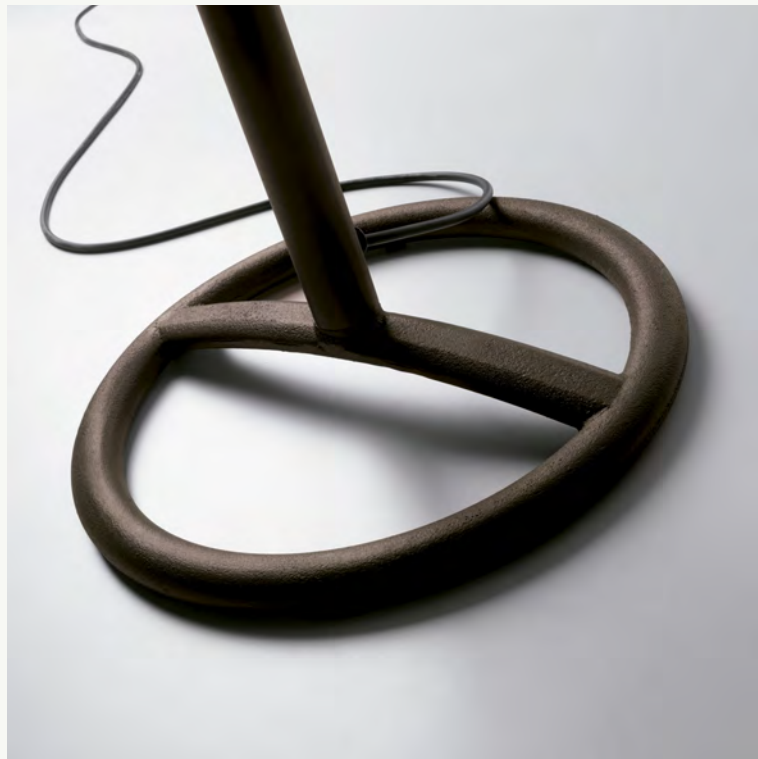
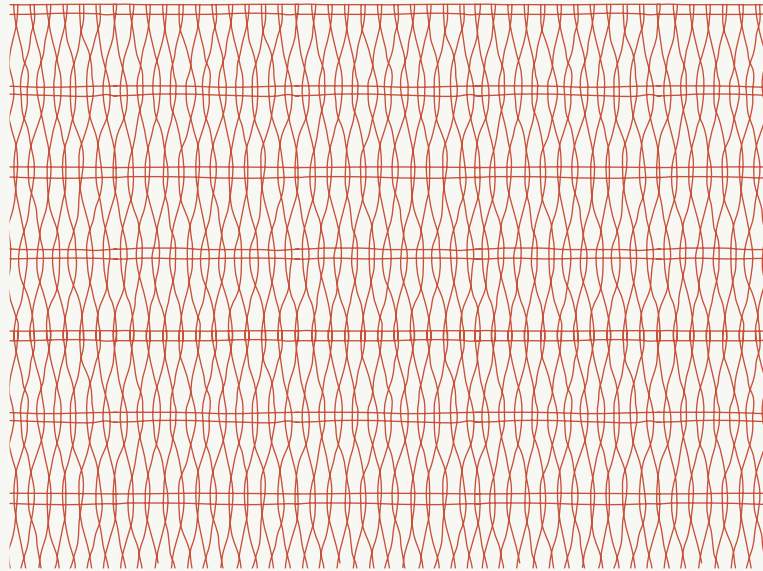









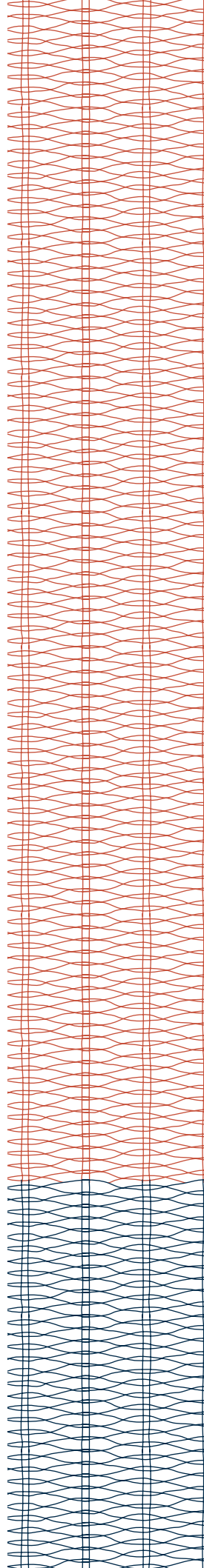









*Moss Floristas / Madrid  
Fotografía: María Nieto Raventós*











## Fora M

Mesa Exterior  
Outdoor Table Lamp

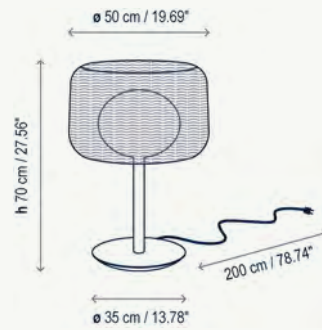

2230301/P695 Blanco Roto - Pantalla Beige Claro  
Natural White - Shade Light Beige

2230303/P696 Marrón Grafito - Pantalla Marrón Rattan  
Graphite Brown - Shade Rattan Brown

## Fora P

Pie Exterior  
Outdoor Floor Lamp

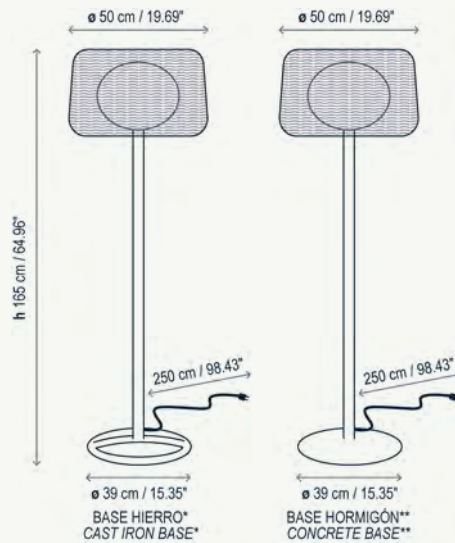

3130301/P695 Blanco Roto - Base Hormigon Beige  
Pantalla Beige Claro  
Natural White - Beige Concrete Base  
Shade Light Beige

3030301/P695 Blanco Roto - Pantalla Beige Claro  
Natural White - Shade Light Beige

3030303/P696 Marrón Grafito - Pantalla Marrón Rattan  
Graphite Brown - Shade Rattan Brown

3130303/P696 Marrón Grafito - Base Hormigon Gris  
Pantalla Marrón Rattan  
Graphite Brown - Gray Concrete Base  
Shade Rattan Brown

\*Consulte las opciones de anclaje al suelo  
\*Consult for floor fastening options.

\*\*Debido a su peso y resistencia, la base de hormigón es aconsejable en zonas con alto grado de salinidad o condiciones climáticas difíciles o adversas.

\*\*For its weight and strength, the concrete base is recommended in areas with high salinity or extremely adverse weather conditions.

## Fora S

Suspensión Exterior  
Outdoor Pendant Lamp



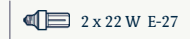

 2 x 22 W E-27

 2 x 9 W LED E-27 A60

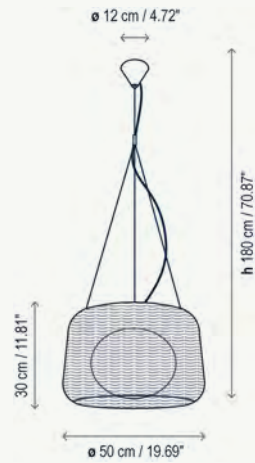

4130301/P695C Blanco Roto - Pantalla Beige Claro  
Natural White - Shade Light Beige

4130303/P696C Marrón Grafito - Pantalla Marrón Rattan  
Graphite Brown - Shade Rattan Brown

## Fora 90

Suspensión Exterior  
Outdoor Pendant Lamp



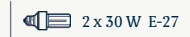

 2 x 30 W E-27

 2 x 9 W LED E-27 A60

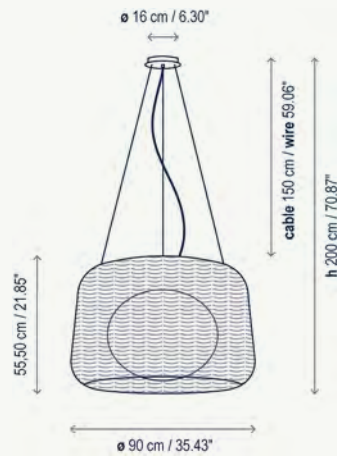

4030301/P707C Blanco Roto - Pantalla Beige Claro  
Natural White - Shade Light Beige

4030303/P708C Marrón Grafito - Pantalla Marrón Rattan  
Graphite Brown - Shade Rattan Brown

## Familia / Family

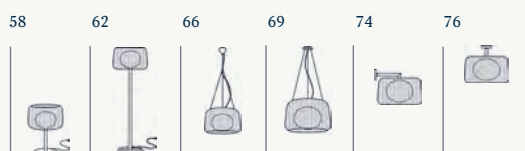

## Materiales / Materials

Aluminio - Acero inoxidable - Polietileno - Fibra sintética  
Aluminum - Stainless steel - Polyethylene - Synthetic fiber

Todas las fibras sintéticas utilizadas por Bover son reciclables y no tóxicas para la sostenibilidad del medio ambiente

All synthetic fibers used by Bover are recyclable and non-toxic for environmental sustainability.

### Fora A

Aplique Exterior  
Outdoor Wall Lamp

- ⎓ | ⚡ | IP 65 | 230V | 50Hz
- ⚡ | CE | ENEC
- 💡 2 x 22 W E-27
- 💡 2 x 9 W LED E-27 A60

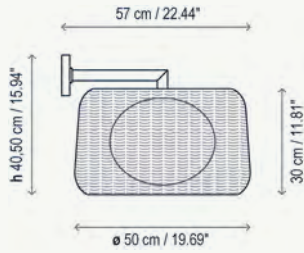

1130301/P695C Blanco Roto - Pantalla Beige Claro  
Natural White - Shade Light Beige

1130303/P696C Marrón Grafito - Pantalla Marrón Rattan  
Graphite Brown - Shade Rattan Brown

### Fora PF

Plafón Exterior  
Outdoor Ceiling Lamp

- ⎓ | ⚡ | IP 65 | 230V | 50Hz
- ⚡ | CE | ENEC
- 💡 2 x 22 W E-27
- 💡 2 x 9 W LED E-27 A60

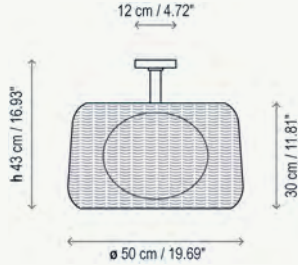

5130301/P695C Blanco Roto - Pantalla Beige Claro  
Natural White - Shade Light Beige

5130303/P696C Marrón Grafito - Pantalla Marrón Rattan  
Graphite Brown - Shade Rattan Brown

### Acabados / Finishing



Blanco Roto  
Natural White

Marrón Grafito  
Graphite Brown

Beige Claro  
Light Beige

Marrón Rattan  
Rattan Brown

# Garota

by Alex Fernández Camps / Gonzalo Milà | 2015





Garota, inspirada en el caparazón de un erizo de mar, nos ofrece una luz cálida y tamizada; envuelta en formas orgánicas, redondeadas y sutiles; pensada para acompañarnos en zonas de interior y exterior indistintamente.

*Garota, inspired by a sea urchin's shell, offers us a warm and dispersed light; wrapped in organic, rounded and subtle forms; designed to indistinctly accompany us in interior and exterior areas.*



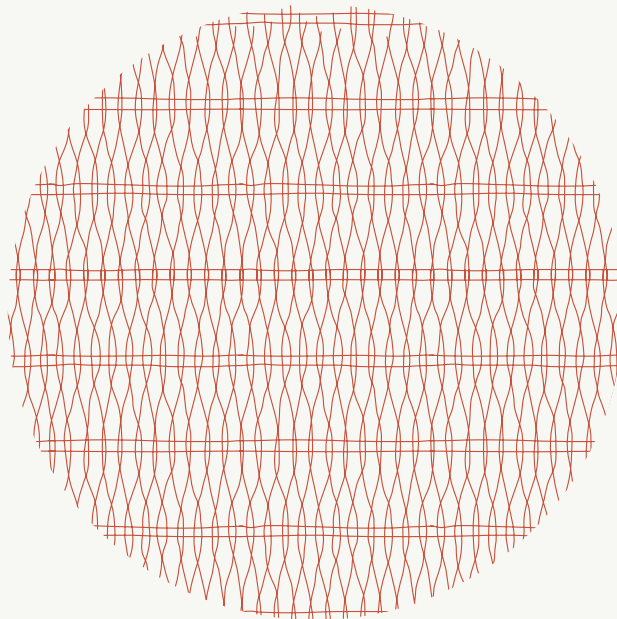







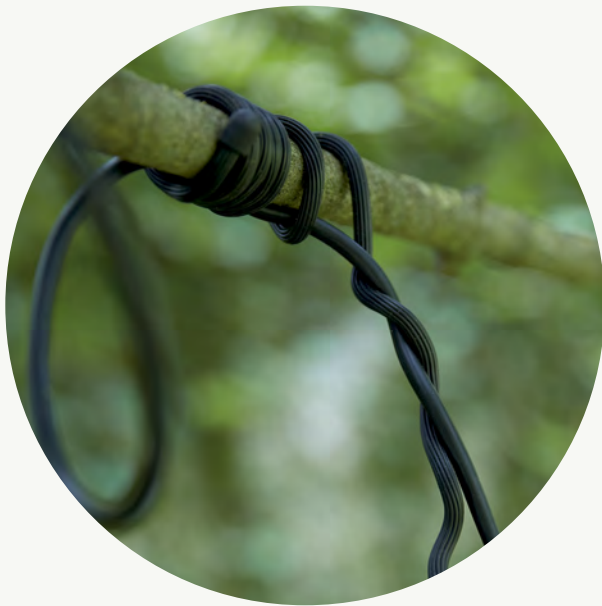





*Gran Meliá Palacio de los Duques / Madrid - Spain*









*Hostal Empúries / L'Escala*





## Garota A/01

Aplique Exterior  
Outdoor Wall Lamp

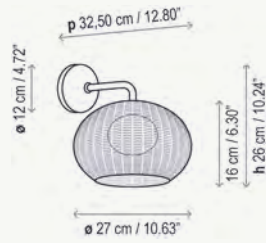

3350701201/P803 Dimable TRIAC - Blanco Roto  
Pantalla Blanco Marfil  
TRIAC Dimmable - Natural White  
Ivory White Shade

3350701203/P804 Dimable TRIAC - Marrón Grafito  
Pantalla Marrón  
TRIAC Dimmable - Graphite Brown  
Brown Shade

3350701201/P804 Dimable TRIAC Blanco Roto  
Pantalla Marrón  
TRIAC Dimmable Natural White  
Brown Shade

3350701203/P803 Dimable TRIAC Marrón Grafito  
Pantalla Blanco Marfil  
TRIAC Dimmable Graphite Brown  
Ivory White Shade

## Garota PF/01

Plafón Exterior  
Outdoor Ceiling Lamp



3350110401/P803 Dimable TRIAC - Blanco Roto  
Pantalla Blanco Marfil  
TRIAC Dimmable - Natural White  
Ivory White Shade

3350110403/P804 Dimable TRIAC - Marrón Grafito  
Pantalla Marrón  
TRIAC Dimmable - Graphite Brown  
Brown Shade

3350110401/P804 Dimable TRIAC Blanco Roto  
Pantalla Marrón  
TRIAC Dimmable - Natural White  
Brown Shade

3350110403/P803 Dimable TRIAC Marrón Grafito  
Pantalla Blanco Marfil  
TRIAC Dimmable - Graphite Brown  
Ivory White Shade

## Garota PF/02

Plafón Exterior  
Outdoor Ceiling Lamp

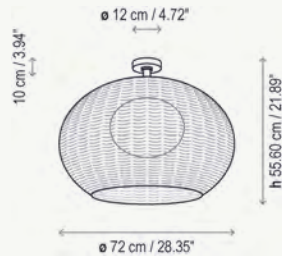

3350210001/P801 Blanco Roto - Pantalla Blanco Marfil  
Natural White - Ivory White Shade

3350210001/P802 Blanco Roto - Pantalla Marrón  
Natural White - Brown Shade

3350210003/P801 Marrón Grafito - Pantalla Blanco Marfil  
Graphite Brown - Ivory White Shade

3350210003/P802 Marrón Grafito - Pantalla Marrón  
Graphite Brown - Brown Shade

## Garota Hang

Suspensión Exterior  
Outdoor Pendant Lamp

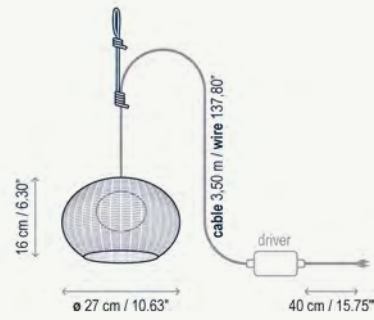

3350720101/P803 Blanco Roto  
Pantalla Blanco Marfil  
*Natural White  
Ivory White Shade*

3350720101/P804 Blanco Roto  
Pantalla Marrón  
*Natural White  
Brown Shade*

3350720103/P804 Marrón Grafito  
Pantalla Marrón  
*Graphite Brown  
Brown Shade*

3350720103/P805 Marrón Grafito  
Pantalla Blanco Marfil  
*Graphite Brown  
Brown Shade*

Sin interruptor. Transformador instalado en el cable.  
*Without switch. The driver is installed on the cable.*

Longitud total del cable: 4 metros  
*Total cable length: 157.48 inches.*

## Garota S/01

Suspensión Exterior  
Outdoor Pendant Lamp

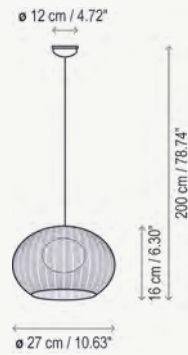

3350121401/P803 Dimable TRIAC - Blanco Roto  
Pantalla Blanco Marfil  
*TRIAC Dimmable - Natural White  
Ivory White Shade*

3350121403/P804 Dimable TRIAC - Marrón Grafito  
Pantalla Marrón  
*TRIAC Dimmable - Graphite Brown  
Brown Shade*

3350121401/P804 Dimable TRIAC - Blanco Roto  
Pantalla Marrón  
*TRIAC Dimmable - Natural White  
Brown Shade*

3350121403/P803 Dimable TRIAC - Marrón Grafito  
Pantalla Blanco Marfil  
*TRIAC Dimmable - Graphite Brown  
Ivory White Shade*

## Garota S/02

Suspensión Exterior  
Outdoor Pendant Lamp

|  |                      |       |              |
|--|----------------------|-------|--------------|
|  |                      | IP 65 | 230V<br>50Hz |
|  |                      |       |              |
|  | 2 x 22 W E-27        |       |              |
|  | 2 x 9 W LED E-27 A60 |       |              |

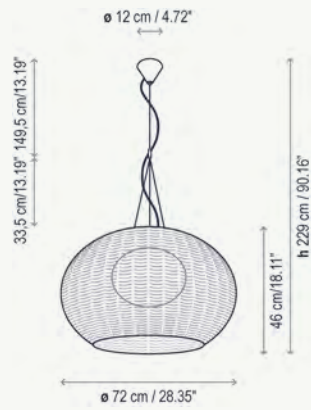

3350220201/P801 Blanco Roto - Pantalla Blanco Marfil  
*Natural White - Ivory White Shade*

3350220203/P802 Marrón Grafito - Pantalla Marrón  
*Graphite Brown - Brown Shade*

3350220201/P802 Blanco Roto - Pantalla Marrón  
*Natural White - Brown Shade*

3350220203/P801 Marrón Grafito - Pantalla Blanco Marfil  
*Graphite Brown - Ivory White Shade*

## Garota Mini

Sobremesa Exterior  
Outdoor Table Lamp

|  |   |       |              |
|--|---|-------|--------------|
|  |   | IP 65 | 230V<br>50Hz |
|  |   |       |              |
|  | 1 x 9 W LED<br>960 lm / CRI: 90 / 2700° K |       |              |

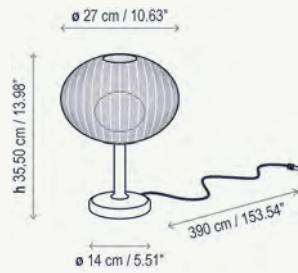

3350630101/P803 Blanco Roto - Pantalla Blanco Marfil  
*Natural White - Ivory White Shade*

3350630103/P804 Marrón Grafito - Pantalla Marrón  
*Graphite Brown - Brown Shade*

Cable neopreno negro directo a corriente sin interruptor  
*Black neoprene cable direct to current*

## Familia / Family

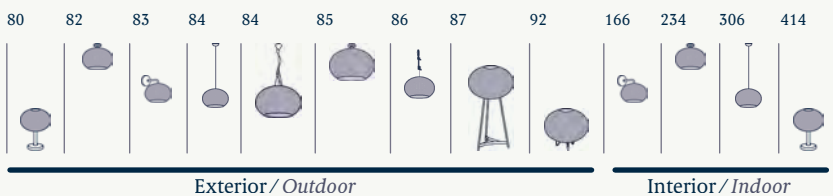



## Garota P/01

Pie Exterior  
Outdoor Floor Lamp

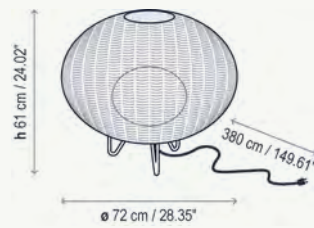

3350130088/P801 Acero Inoxidable 316 - Pantalla Blanco Marfil  
316 Stainless Steel - Ivory White Shade

3350130088/P802 Acero Inoxidable 316 - Pantalla Marrón  
316 Stainless Steel - Brown Shade

Consulte las opciones de anclaje al suelo  
Consult for floor fastening options.

## Garota P/02

Pie Exterior  
Outdoor Floor Lamp

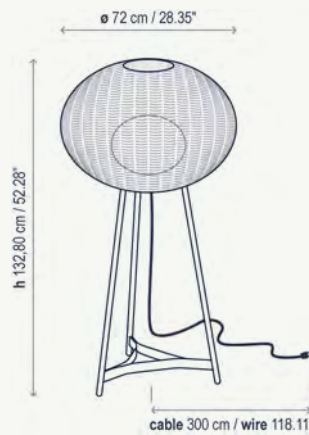

3350230001/P801 Blanco Roto - Pantalla Blanco Marfil  
Natural White - Ivory White Shade

3350230003/P802 Marrón Grafito - Pantalla Marrón  
Graphite Brown - Brown Shade

3350230001/P802 Blanco Roto - Pantalla Marrón  
Natural White - Brown Shade

3350230003/P801 Marrón Grafito - Pantalla Blanco Marfil  
Graphite Brown - Ivory White Shade

Consulte las opciones de anclaje al suelo  
Consult for floor fastening options.  
Altura no modificable / Height non customizable.

### Materiales / Materials

Aluminio - Acero inoxidable - Polietileno - Fibra sintética  
Aluminum - Stainless steel - Polyethylene - Synthetic fiber

Todas las fibras sintéticas utilizadas por Bover son reciclables y no tóxicas para la sostenibilidad del medio ambiente

All synthetic fibers used by Bover are recyclable and non-toxic for environmental sustainability.

### Acabados / Finishing

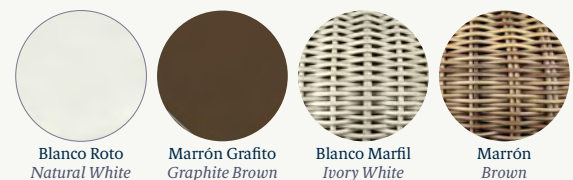

Blanco Roto  
Natural White

Marrón Grafito  
Graphite Brown

Blanco Marfil  
Ivory White

Marrón  
Brown

# Lineana

by Christophe Mathieu | 2010



Contundente y robusta; Lineana es un producto para perdurar. Lineana aporta un renovado aspecto estructural a las persianas de librillo, tan presentes en la arquitectura Mediterránea, que han servido de inspiración para su creación.

*Strong and robust, Lineana is a timeless product. Lineana provides a reference to the structural aspect of window blinds, so present in the Mediterranean architecture which served as an inspiration for its creation.*











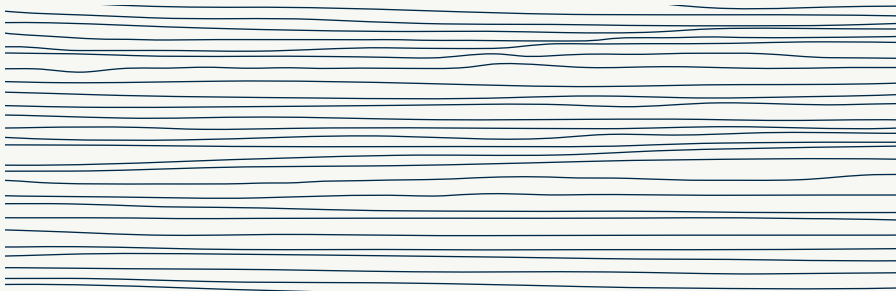



## Lineana H

Aplique Exterior  
Outdoor Wall Lamp



2 x 9 W G9 Bajo consumo

2 x 3,5 W LED G9

26 W LED  
1880 lm / CRI: 80 / 3000° K

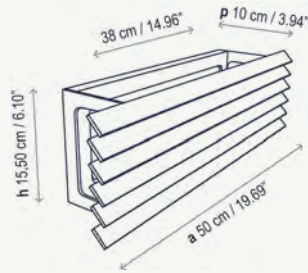

G9

1121208H Gris Grafito  
Grey Graphite

1121203H Marrón Grafito  
Graphite Brown

LED

1121208LH Gris Grafito  
Grey Graphite

1121203LH Marrón Grafito  
Graphite Brown

## Lineana V

Aplique Exterior  
Outdoor Wall Lamp



2 x 9 W G9 Bajo consumo

2 x 3,5 W LED G9

26 W LED  
1880 lm / CRI: 80 / 3000° K

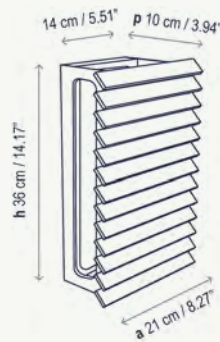

G9

1121208V Gris Grafito  
Grey Graphite

1121203V Marrón Grafito  
Graphite Brown

LED

1121208LV Gris Grafito  
Grey Graphite

1121203LV Marrón Grafito  
Graphite Brown

## Lineana Ipe

Aplique Exterior  
Outdoor Wall Lamp



2 x 9 W G9 Bajo consumo

2 x 3,5 W LED G9

26 W LED  
1880 lm / CRI: 80 / 3000° K

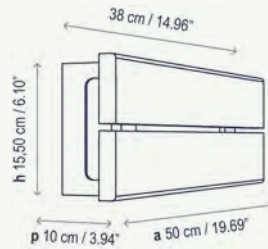

G9

IPE21208H Gris Grafito - Madera Ipe  
Grey Graphite - Ipe Wood

IPE21203H Marrón Grafito - Madera Ipe  
Graphite Brown - Ipe Wood

LED

IPE21208LH Gris Grafito - Madera Ipe  
Grey Graphite - Ipe Wood

IPE21203LH Marrón Grafito - Madera Ipe  
Graphite Brown - Ipe Wood

## Difusor / Diffuser

Polycarbonato  
Polycarbonate

## Materiales / Materials

Acero Inoxidable - Aluminio  
Stainless steel - Aluminum

## Acabados / Finishing



Marrón Grafito  
Graphite Brown

Gris Grafito  
Graphite Grey

IPE  
IPE

# Marietta

by Joana Bover | 2016





Nos llevamos Marietta al exterior; transformando la cinta en una pantalla de polietileno. Resistente, fácil de limpiar y muy polivalente; Marietta se convierte en un todoterreno perfecto para terrazas y restaurantes.

*“We took Marietta outside, transforming the ribbon into a polyethylene shade. Resistant, easy to clean and very versatile; Marietta becomes a perfect all-terrain-lamp for terraces and restaurants.”*









# Marietta S/32 Outdoor

Suspensión Exterior  
Outdoor Pendant Lamp

|  |   |       |              |
|--|---|-------|--------------|
|  |   | IP 65 | 230V<br>50Hz |
|  |   | TRIAC |              |
|  | 1 x 8 W LED<br>664 lm / CRI: 80 / 2700° K |       |              |



3310121413 Dimable TRIAC - Blanco  
Dimmable TRIAC - White

## Familia / Family

|                     |                    |     |
|---------------------|--------------------|-----|
| 106                 | 324                | 324 |
|                     |                    |     |
| Exterior<br>Outdoor | Interior<br>Indoor |     |

## Materiales / Materials

Polietileno de densidad media - Aluminio  
Medium density polyethylen - Aluminum

## Acabados / Finishing

Blanco  
White

# Maxi

by Joana Bover | 2004

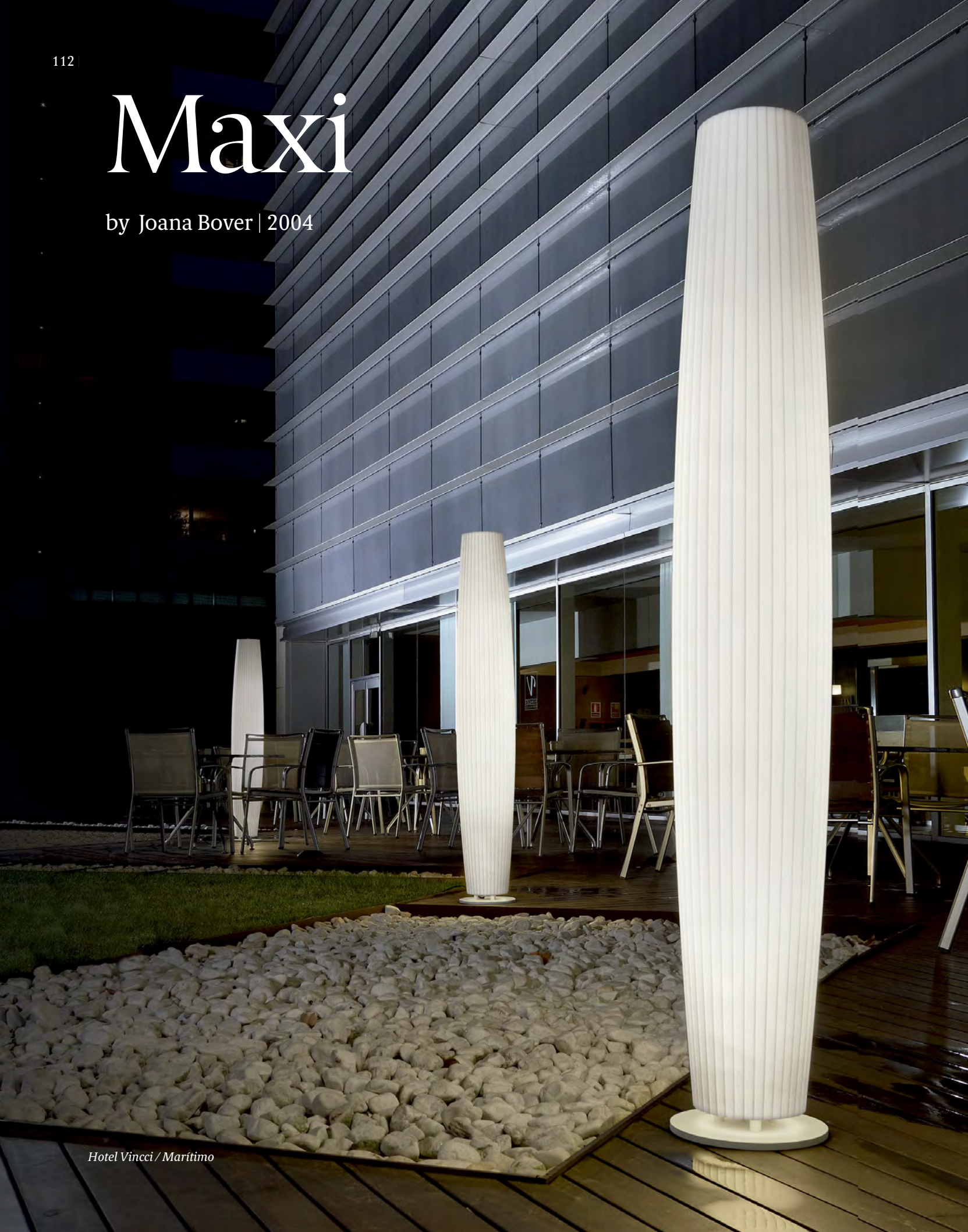





Decidimos dar un paso adelante y llevar a Maxi a jardines y espacios abiertos donde su marcada calidez nos ofrece una buena luz a través de su pantalla de polietileno.

*We decided to reinvent Maxi to bring it to gardens and open spaces where its marked warm feature can offer us a good light coming out from its polythene shade.*



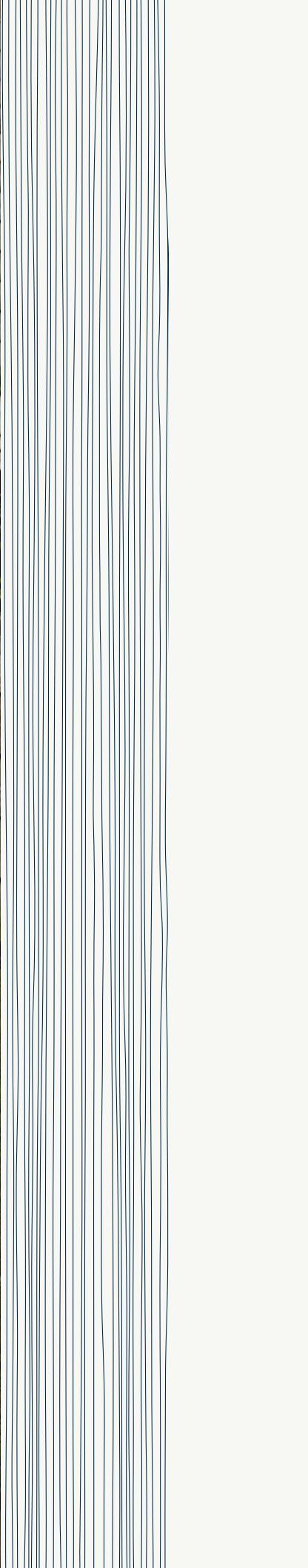



## Maxi S/01 Outdoor

Suspensión Exterior  
Outdoor Pendant Lamp

 IP 65 | 230V  
50Hz



 2 x 28 W T5 HE

 2 x 54 W T5 HO

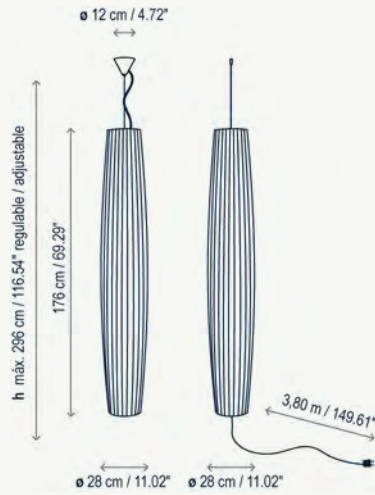

4429500TOP Instalación Superior - Blanco  
Electrical Upper Installation - White

4429500INF Instalación Inferior - Blanco  
Electrical Bottom Installation - White

 IP 65 | 230V  
50Hz



 49,2 W LED  
7500 lm / CRI: 90 / 2700° K

2950120100 Instalación Superior - Blanco - LED  
Electrical Upper Installation - White - LED

2950220100 Instalación Inferior - Blanco - LED  
Electrical Bottom Installation - White - LED

 IP 65 | 230V  
50Hz



 TRIAC

 49,2 W LED  
7500 lm / CRI: 90 / 2700° K

2950121400 LED dimable TRIAC - Instalación Superior - Blanco  
LED TRIAC Dimmable - Electrical Upper Installation  
White

2950221400 LED dimable TRIAC - Instalación Inferior - Blanco  
LED TRIAC Dimmable - Electrical Bottom Installation  
White

Altura regulable cable tensor con seguro / Adjustable tensor wire

Floron acabado blanco (solo para instalacion superior)  
White canopy finished (only for upper installation)

## Familia / Family



## Maxi P/180 Outdoor

Pie Exterior  
Outdoor Floor

IP 65 | 230V  
50Hz



2 x 28 W T5 HE

2 x 54 W T5 HO

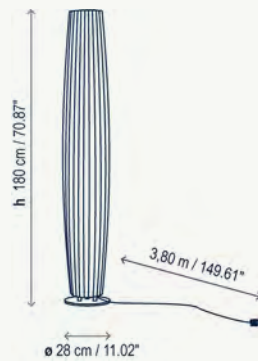

3229500 Blanco  
White

IP 65 | 230V  
50Hz



49.2 W LED  
7500 lm / CRI: 90 / 2700° K

2950130300 LED Blanco  
LED White

IP 65 | 230V  
50Hz



49.2 W LED  
7500 lm / CRI: 90 / 2700° K

2950130400 LED dimable TRIAC - Blanco  
LED TRIAC Dimmable - White

La lámpara de pie puede fijarse al suelo retirando los tapones de goma que se encuentran en la base.

*The floor lamp can be fixed by removing the rubber stoppers placed on the foot base.*

Fijación a suelo con salida de cable empotrado: En este caso el cable utilizado debe ser de goma o superior tipo HO5RN-F de entre 6 y 8 mm de diámetro.

*Floor fastening with built-in cable: In this case, cable should be made out of rubber type HO5RN or superior, with a diameter between 6 and 8 mm.*

### Materiales / Materials

Polietileno de densidad media - Hierro - Acero inoxidable  
Medium density polyethylene - Iron - Stainless steel

### Acabados / Finishing

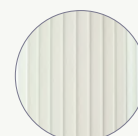

Blanco  
White

# Moai

by Gonzalo Milà | 2017

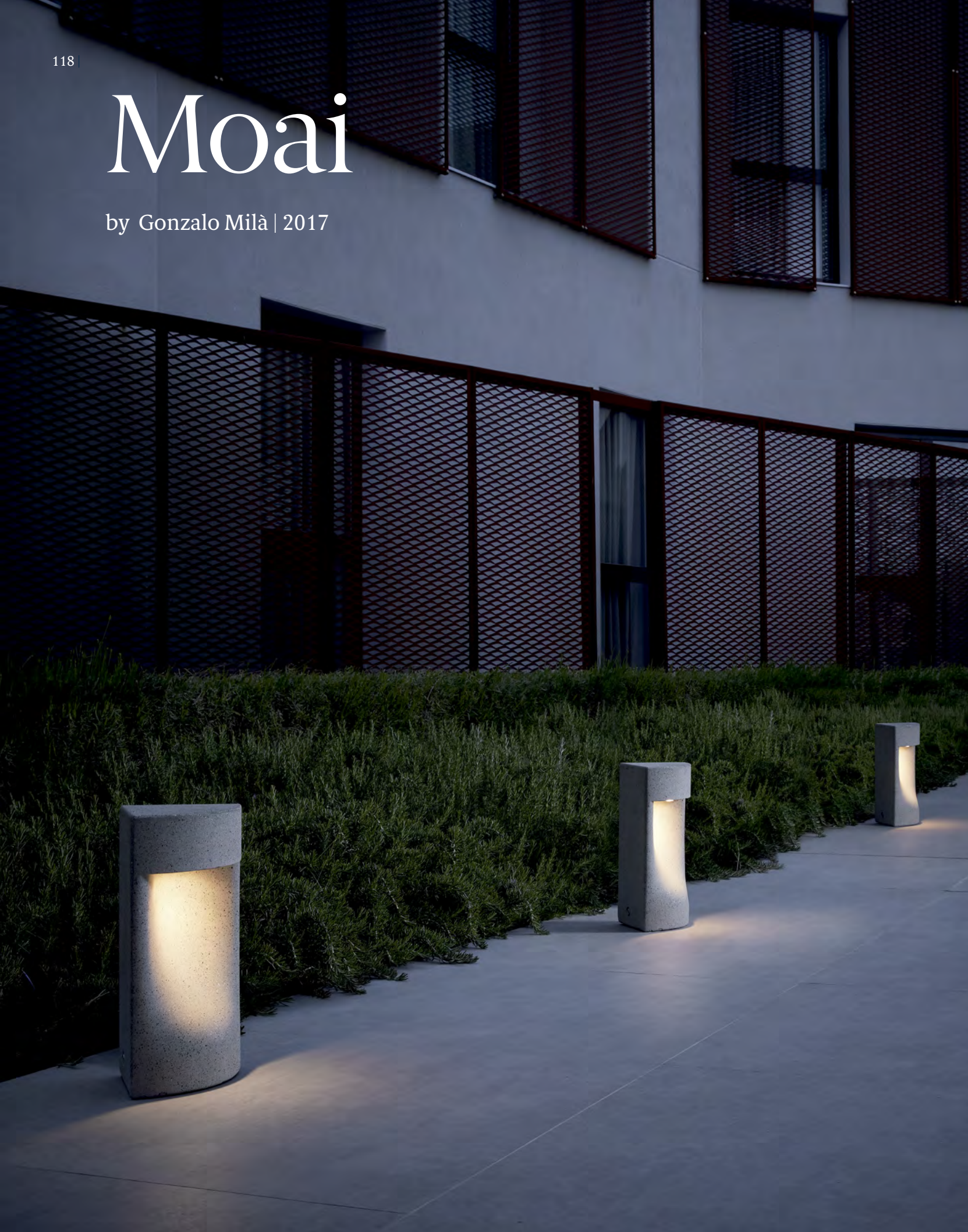



Moai es una lámpara de exterior donde hormigón, forma y luz trabajan juntas para dar protagonismo absoluto a esta sorprendente unión.

*Moai is an outdoor lamp where concrete, shape and light work together to give absolute prominence to this surprising union.*











## Moai B/35

Baliza Exterior  
Outdoor Bollard

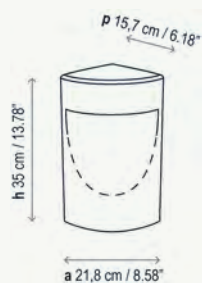

1920140094 Dimable TRIAC - Cemento Gris  
Dimmable TRIAC - Grey Concrete

## Moai B/60

Baliza Exterior  
Outdoor Bollard

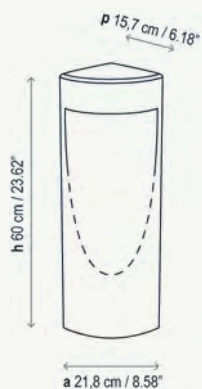

1920240094 Dimable TRIAC - Cemento Gris  
Dimmable TRIAC - Grey Concrete

### Materiales / Materials

Cemento - Acero inoxidable 316  
Concrete - 316 Stainless steel

### Acabados / Finishing

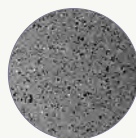

Cemento Gris  
Gray Concrete

Baliza con dos opciones de sujeción:  
Two anchoring options for bollards:

- Fijación a suelo, tornillería y tacos de sujeción no incluidos.  
Anchoring to ground, screws and anchors accessories not included.
- Fijación por cimentación, accesorio de anclaje no incluido.  
Anchoring for foundation, fasteners accessories not included.

# Syra

by Alex Fernández Camps / Gonzalo Milà | 2014



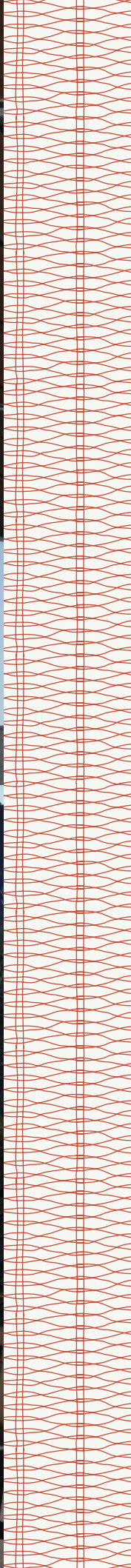

Las Syra son productos ideales para espacios que necesiten luz cálida y elementos amables que ofrezcan buenas dosis de confort.

*The Syra are ideal products for spaces that need warm light and friendly elements that offer good doses of comfort.*



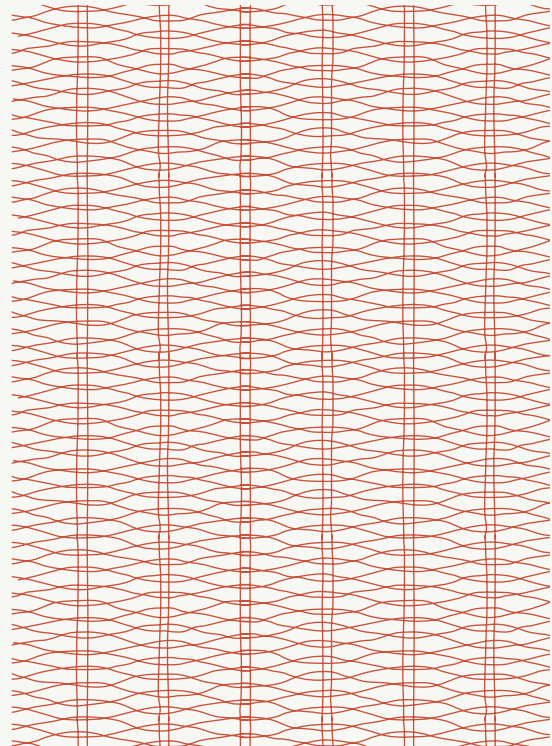







## Syra 60 Outdoor

Suspensión Exterior  
Outdoor Pendant Lamp

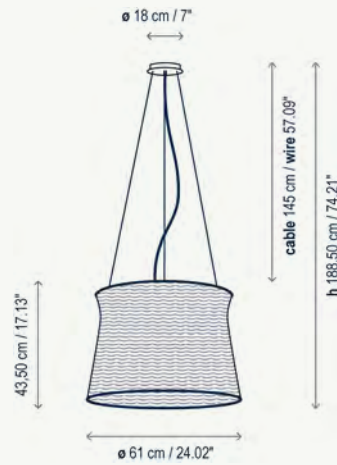

- 26402201100 Estructura Blanco Roto - Pantalla Blanco Marfil  
*Structure Natural White - Ivory White Shade*
- 26402201101 Estructura Marrón Grafito - Pantalla Marrón  
*Structure Graphite Brown - Brown Shade*
- \*26402203100 Regulable Sistema DALI  
Estructura Blanco Roto - Pantalla Blanco Marfil  
*DALI Dimming System*  
*Structure Natural White - Ivory White Shade*
- \*26402203101 Regulable Sistema DALI  
Estructura Marrón Grafito - Pantalla Marrón  
*DALI Dimming System*  
*Structure Graphite Brown - Brown Shade*

## Syra 90 Outdoor

Suspensión Exterior  
Outdoor Pendant Lamp

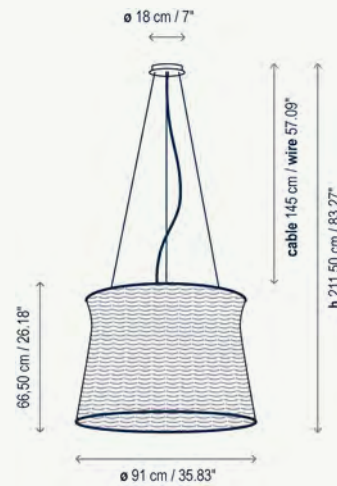

- 26403201100 Estructura Blanco Roto - Pantalla Blanco Marfil  
*Structure Natural White - Ivory White Shade*
- 26403201101 Estructura Marrón Grafito - Pantalla Marrón  
*Structure Graphite Brown - Brown Shade*
- \*26403203100 Regulable Sistema DALI  
Estructura Blanco Roto - Pantalla Blanco Marfil  
*DALI Dimming System*  
*Structure Natural White - Ivory White Shade*
- \*26403203101 Regulable Sistema DALI  
Estructura Marrón Grafito - Pantalla Marrón  
*DALI Dimming System*  
*Structure Graphite Brown - Brown Shade*

### Difusor / Diffuser

Cristal soplado opal  
*Opal blown glass*

### Materiales / Materials

Aluminio - Hierro - Fibra sintética  
*Aluminum - Iron - Syntetic fiber*

### Familia / Family



### Acabados / Finishing

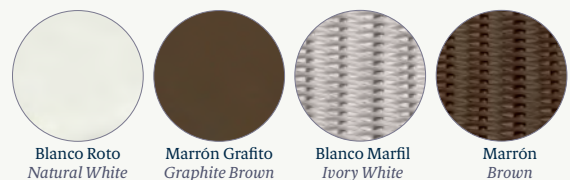

# Indoor





En Bover creemos que la combinación adecuada entre diseño y desarrollo técnico es crucial para el desarrollo de un producto exitoso. Nos gusta decir que creamos iluminación de diseño contemporáneo hecha con el corazón. Contemporáneo porque son piezas que saben mantener el equilibrio entre calidad y las formas dando lugar a un estilo intemporal. Hechas con el corazón porque nos encanta cuidar hasta el más mínimo detalle.

*At Bover we believe that the right combination of design and technical development is crucial to the development of a successful product. We like to say that we create “heart made contemporary design lighting pieces”. Contemporary because they are pieces that know how to maintain the balance between quality and shapes giving way to products that will remain actual in the future. Made with the heart because we love to take care of every detail.*

# Alba

by Rubén Saldaña | 2014





Alba es un aplique de diseño arquitectural con la estructura frontal de madera o acero; especialmente indicado para iluminar elementos que requieran una luz directa y uniforme.

*Alba is an architecturally designed wall sconce with frontal decorative plate in aluminum or wood; especially suitable to project light over elements requiring direct and uniform light.*



## Alba 60

Aplique / Wall Lamp

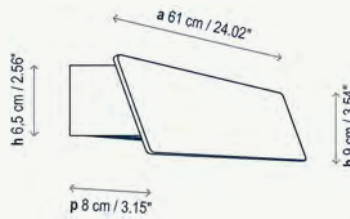

- 2270100263 Blanco - Madera Roble / White - Oak Wood
- 2270100264 Aluminio Pulido / Polished Aluminum
- 2270100265 Blanco / White
- \*2270100463 Regulable Sistema DALI / Blanco - Madera Roble  
DALI Dimming System / White - Oak Wood
- \*2270100464 Regulable Sistema DALI / Aluminio Pulido  
DALI Dimming System / Polished Aluminum
- \*2270100465 Regulable Sistema DALI / Blanco  
DALI Dimming System / White



- 2270100663 Blanco - Madera Roble  
White - Oak Wood
- 2270100664 Aluminio Pulido  
Polished Aluminum
- 2270100665 Blanco  
White

## Alba 90

Aplique / Wall Lamp

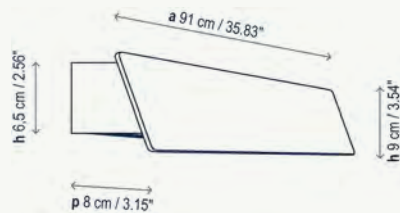

- 2270200263 Blanco - Madera Roble / White - Oak Wood
- 2270200264 Aluminio Pulido / Polished Aluminum
- 2270200265 Blanco / White
- \*2270200463 Regulable Sistema DALI / Blanco - Madera Roble  
DALI Dimming System / White - Oak Wood
- \*2270200464 Regulable Sistema DALI / Aluminio Pulido  
DALI Dimming System / Polished Aluminum
- \*2270200465 Regulable Sistema DALI / Blanco  
DALI Dimming System / White



- 2270200663 Blanco - Madera Roble  
White - Oak Wood
- 2270200664 Aluminio Pulido  
Polished Aluminum
- 2270200665 Blanco  
White

## Difusor / Diffuser

Policarbonato  
Polycarbonate

## Familia / Family

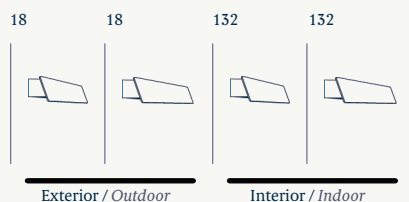

## Materiales / Materials

Aluminio - Hierro - Madera acabado roble  
Aluminum - Iron - Wood finished oak

## Acabados / Finishing



# Basik

by Joana Bover | 2010





## Basik 02

Aplique / Wall Lamp



1 x 46 W Classic P Eco E-27

1 x 11 W E-27

1 x 6 W LED E-27 P48

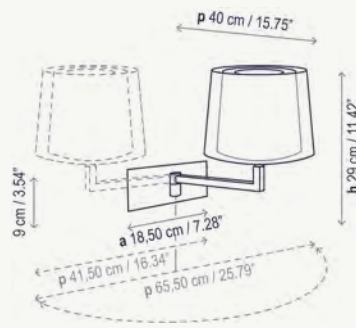

- 1132105/P634E Níquel Satinado - Cinta Translúcida Blanca  
*Satin Nickel - White Translucent Ribbon*
- 1132105/P635E Níquel Satinado - Cinta Translúcida Crema  
*Satin Nickel - Cream Translucent Ribbon*
- 1132105/P633E Níquel Satinado - Cotonet Blanco  
*Satin Nickel - White Cotton*
- 1132105/P636E/P636I  
Níquel Satinado  
Pantalla Interior y Exterior Malla Negra  
*Satin Nickel  
Outer & Inner Lampshade Black Mesh*
- 1132105/P637E/P637I  
Níquel Satinado  
Pantalla Interior y Exterior Malla Roja  
*Satin Nickel  
Outer & Inner Lampshade Red Mesh*
- 1132106/P634E Cromo Brillante - Cinta Translúcida Blanca  
*Brilliant Chrome - White Translucent Ribbon*
- 1132106/P635E Cromo Brillante - Cinta Translúcida Crema  
*Brilliant Chrome - Cream Translucent Ribbon*
- 1132106/P633E Cromo Brillante - Cotonet Blanco  
*Brilliant Chrome - White Cotton*
- 1132106/P636E/P636I  
Cromo Brillante  
Pantalla Interior y Exterior Malla Negra  
*Brilliant Chrome  
Outer & Inner Lampshade Black Mesh*
- 1132106/P637E/P637I  
Cromo Brillante  
Pantalla Interior y Exterior Malla Roja  
*Brilliant Chrome  
Outer & Inner Lampshade Red Mesh*

Basik es una solución de lectura elegante para el cabezal de la cama. Dispone de diversas opciones de pantalla y un brazo que gira 180°.

*Basik is an elegant solution for bedside reading. Showcasing a rich combination of shades and an arm that rotates 180°.*

### Materiales / Materials

Latón - Hierro  
*Brass - Iron*

### Acabados / Finishing

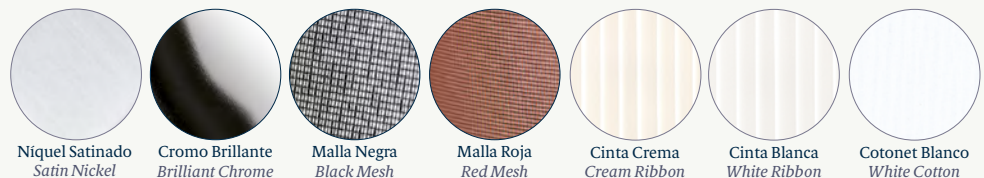

Níquel Satinado  
*Satin Nickel*

Cromo Brillante  
*Brilliant Chrome*

Malla Negra  
*Black Mesh*

Malla Roja  
*Red Mesh*

Cinta Crema  
*Cream Ribbon*

Cinta Blanca  
*White Ribbon*

Cotonet Blanco  
*White Cotton*

# BCN

by Joana Bover | 2012





BCN es un aplique de diseño contemporáneo ideal para iluminar pasillos, espejos o zonas que necesiten una luz clara, directa y uniforme.

*BCN is a wall lamp with a contemporary design especially projected to light corridors, mirrors or areas requiring a clear, direct and uniform light.*





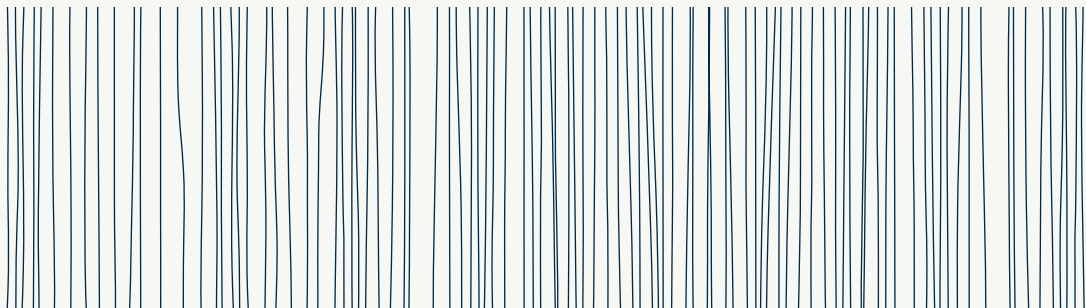



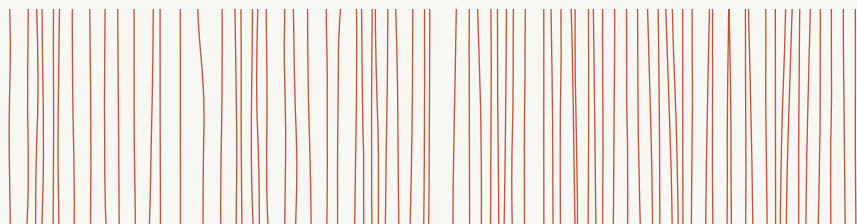





**BCN**

Aplique / Wall Lamp

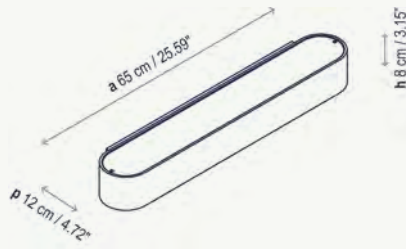

- 1526501 Blanco Lacado Brillante  
*White Brilliant Lacquer*
- 1526523 Negro Lacado Brillante  
*Black Brilliant Lacquer*
- \*D1526501 Regulable Sistema DALI / Blanco Lacado Brillante  
*DALI Dimming System / White Brilliant Lacquer*
- \*D1526523 Regulable Sistema DALI / Negro Lacado Brillante  
*DALI Dimming System / Black Brilliant Lacquer*

**Difusores / Diffusers**Cristal Óptico  
*Optical Glass***Materiales / Materials**Poliuretano lacado brillante  
*Brilliant lacquer polyurethane***Acabados / Finishing****BCN 01**

Aplique / Wall Lamp

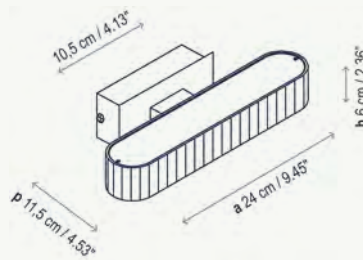

- 2650101247 Dimable TRIAC  
Níquel Satinado - Cinta Translúcida Crema  
*TRIAC Dimmable  
Satin Nickel - Cream Translucent Ribbon*
- 2650101248 Dimable TRIAC  
Níquel Satinado - Cinta Translúcida Blanca  
*TRIAC Dimmable  
Satin Nickel - White Translucent Ribbon*
- 2650101249 Dimable TRIAC  
Níquel Satinado - Cinta Translúcida Roja  
*TRIAC Dimmable  
Satin Nickel - Red Translucent Ribbon*
- 2650101250 Dimable TRIAC  
Cromo - Cinta Translúcida Crema  
*TRIAC Dimmable  
Chrome - Cream Translucent Ribbon*
- 2650101251 Dimable TRIAC  
Cromo - Cinta Translúcida Blanca  
*TRIAC Dimmable  
Chrome - White Translucent Ribbon*
- 2650101252 Dimable TRIAC  
Cromo - Cinta Translúcida Roja  
*TRIAC Dimmable  
Chrome - Red Translucent Ribbon*

## BCN 02

Aplique / Wall Lamp

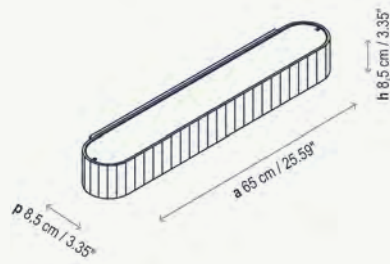

2650200353 Blanco - Cinta Translúcida Crema  
*White - Cream Translucent Ribbon*

2650200354 Blanco - Cinta Translúcida Blanca  
*White - White Translucent Ribbon*

2650200355 Blanco - Cinta Translúcida Roja  
*White - Red Translucent Ribbon*

\*2650200453 Dimable DALI - Blanco  
Cinta Translúcida Crema  
*Dimable DALI - White  
Cream Translucent Ribbon*

\*2650200454 Dimable DALI - Blanco  
Cinta Translúcida Blanca  
*Dimable DALI - White  
White Translucent Ribbon*

\*2650200455 Dimable DALI - Blanco  
Cinta Translúcida Roja  
*Dimable DALI - White  
Red Translucent Ribbon*



2650201253 Dimable TRIAC - Blanco  
Cinta Translúcida Crema  
*TRIAC Dimmable - White  
Cream Translucent Ribbon*

2650201254 Dimable TRIAC - Blanco  
Cinta Translúcida Blanca  
*TRIAC Dimmable - White  
White Translucent Ribbon*

2650201255 Dimable TRIAC - Blanco  
Cinta Translúcida Roja  
*TRIAC Dimmable - White  
Red Translucent Ribbon*

### Difusores / Diffusers

Policarbonato  
*Polycarbonate*

### Materiales / Materials

Hierro  
*Iron*

### Acabados / Finishing



Níquel Satinado  
*Satin Nickel*

Cromo Brillante  
*Brilliant Chrome*

Cinta Crema  
*Cream Ribbon*

Cinta Blanca  
*White Ribbon*

Cinta Roja  
*Red Ribbon*

# Carlota

by Joana Bover | 2003





Carlota es un aplique  
sobrio e intemporal  
que ha conseguido  
superar las tendencias  
y encontrar su lugar sin  
estridencias.

*Carlota is a restrained  
and timeless wall lamp  
that has been able to  
surpass the trends and  
find its place without  
distraction.*



## Carlota A

Aplique / Wall Lamp



1 x 46 W Classic P Eco E-27

1 x 6 W LED E-27 P48



- 1024005/P202 Níquel Satinado / Cinta Translúcida Blanca  
*Satin Nickel / White Translucent Ribbon*
- 1024005/P203 Níquel Satinado / Cinta Translúcida Crema  
*Satin Nickel / Cream Translucent Ribbon*
- 1024005/P107 Níquel Satinado / Cotonet  
*Satin Nickel / Cotton*
- 1024006/P202 Cromo Brillante / Cinta Translúcida Blanca  
*Brilliant Chrome / White Translucent Ribbon*
- 1024006/P203 Cromo Brillante / Cinta Translúcida Crema  
*Brilliant Chrome / Cream Translucent Ribbon*
- 1024006/P107 Cromo Brillante / Cotonet  
*Brilliant Chrome / Cotton*
- 1024060/P202 Níquel Piel Oscura / Cinta Translúcida Blanca  
*Nickel Dark Brown Leather / White Translucent Ribbon*
- 1024060/P203 Níquel Piel Oscura / Cinta Translúcida Crema  
*Nickel Dark Brown Leather / Cream Translucent Ribbon*
- 1024060/P107 Níquel Piel Oscura / Cotonet  
*Nickel Dark Brown Leather / Cotton*

---

Pantalla cuadrada 20 x 15 x 10 cm  
*Square lampshade 7.87" x 5.91" x 3.94"*

Brazo móvil / *Swivel arm*

## Carlota G

Aplique / Wall Lamp



1 x 46 W Classic P Eco E-27

1 x 11 W E-27

1 x 6 W LED E-27 P48



- 1524005/P486 Níquel Satinado / Cinta Translúcida Blanca  
*Satin Nickel / White Translucent Ribbon*
- 1524005/P489 Níquel Satinado / Cinta Translúcida Crema  
*Satin Nickel / Cream Translucent Ribbon*
- 1524005/P487 Níquel Satinado / Cotonet  
*Satin Nickel / Cotton*
- 1524006/P486 Cromo Brillante / Cinta Translúcida Blanca  
*Brilliant Chrome / White Translucent Ribbon*
- 1524006/P489 Cromo Brillante / Cinta Translúcida Crema  
*Brilliant Chrome / Cream Translucent Ribbon*
- 1524006/P487 Cromo Brillante / Cotonet  
*Brilliant Chrome / Cotton*
- 1524060/P486 Níquel Piel Oscura / Cinta Translúcida Blanca  
*Nickel Dark Brown Leather / White Translucent Ribbon*
- 1524060/P489 Níquel Piel Oscura / Cinta Translúcida Crema  
*Nickel Dark Brown Leather / Cream Translucent Ribbon*
- 1524060/P487 Níquel Piel Oscura / Cotonet  
*Nickel Dark Brown Leather / Cotton*

---

Pantalla cuadrada 23 x 17 x 12 cm  
*Square lampshade 9.06" x 6.69" x 4.72"*

Brazo móvil / *Swivel arm*



## Carlota G FL

Aplique / Wall Lamp



1 x 46 W Classic P Eco E-27

1 x 11 W E-27

1 x 6 W LED E-27 P48

1,2 W LED / 45°  
85 lm / CRI: 90 / 2900° K

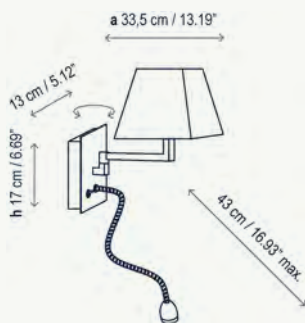

F524005/P486 Níquel Satinado / Cinta Translúcida Blanca  
Satin Nickel / White Translucent Ribbon

F524005/P489 Níquel Satinado / Cinta Translúcida Crema  
Satin Nickel / Cream Translucent Ribbon

F524005/P487 Níquel Satinado / Cotonet  
Satin Nickel / Cotton

F524006/P486 Cromo Brillante / Cinta Translúcida Blanca  
Brilliant Chrome / White Translucent Ribbon

F524006/P489 Cromo Brillante / Cinta Translúcida Crema  
Brilliant Chrome / Cream Translucent Ribbon

F524006/P487 Cromo Brillante / Cotonet  
Brilliant Chrome / Cotton

F524060/P486 Níquel Piel Oscura / Cinta Translúcida Blanca  
Nickel Dark Brown Leather / White Translucent Ribbon

F524060/P489 Níquel Piel Oscura / Cinta Translúcida Crema  
Nickel Dark Brown Leather / Cream Translucent Ribbon

F524060/P487 Níquel Piel Oscura / Cotonet  
Nickel Dark Brown Leather / Cotton

Pantalla cuadrada 23 x 17 x 12 cm  
Square lampshade 9.06" x 6.69" x 4.72"

Brazo móvil / Swivel arm

Flexo de latón para asegurar una mayor flexibilidad y rigidez  
Flexo made in brass to ensure greater flexibility and rigidity

### Materiales / Materials

Latón - Hierro  
Brass - Iron

### Acabados / Finishing



Cotonet  
Cotton



Cinta Blanca  
White Ribbon

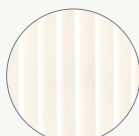

Cinta Crema  
Cream Ribbon



Níquel Satinado  
Satin Nickel



Cromo Brillante  
Brilliant Chrome



Piel Oscura  
Dark Leather

# Drip/Drop

by Christophe Mathieu | 2017





Drip y Drop te cautivan desde la distancia, su diseño te sorprende cuando te acercas y te invita a encenderlas. Es ahí donde la magia alcanza su máximo esplendor:

*Drip and Drop models are captivating from a distance, their design surprises even more when up close, inviting one to illuminate them. That is when they reach their greatest splendor.*









### Drip A/01

Aplique / Wall Lamp

230V  
50Hz  
 3 W LED  
345 lm / CRI: 90 / 2700° K

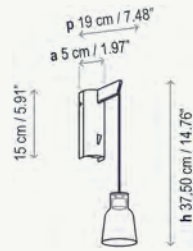

- 2590100738 Ébano Negro - Vidrio Transparente  
*Black Ebony - Transparent Glass*
- 2590100739 Ébano Negro - Vidrio Matizado  
*Black Ebony - Frosted Glass*
- 2590100781 Ébano Negro - Vidrio Verde  
*Black Ebony - Green Glass*
- 2590100786 Ébano Negro - Vidrio Azul  
*Black Ebony - Blue Glass*

Con interruptor / With switch

### Drip A/02

Aplique / Wall Lamp

230V  
50Hz  
 3 W LED  
345 lm / CRI: 90 / 2700° K

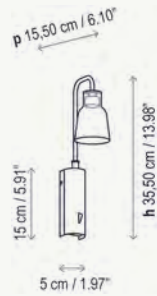

- 2590200738 Ébano Negro - Vidrio Transparente  
*Black Ebony - Transparent Glass*
- 2590200739 Ébano Negro - Vidrio Matizado  
*Black Ebony - Frosted Glass*
- 2590200781 Ébano Negro - Vidrio Verde  
*Black Ebony - Green Glass*
- 2590200786 Ébano Negro - Vidrio Azul  
*Black Ebony - Blue Glass*

Con interruptor / With switch

### Drip A/03

Aplique / Wall Lamp

230V  
50Hz  
 3 W LED  
345 lm / CRI: 90 / 2700° K

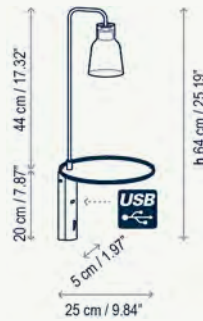

- 2590300738 Ébano Negro - Vidrio Transparente  
*Black Ebony - Transparent Glass*
- 2590300739 Ébano Negro - Vidrio Matizado  
*Black Ebony - Frosted Glass*
- 2590300781 Ébano Negro - Vidrio Verde  
*Black Ebony - Green Glass*
- 2590300786 Ébano Negro - Vidrio Azul  
*Black Ebony - Blue Glass*

Tejido interior de la bandeja en color marrón topo  
*The inside of the tray includes a taupe coated fabric*  
 Capacidad carga de la bandeja : 2 Kg  
*Weight capacity of the tray: 2 Kg*  
 Con interruptor / With switch

### Familia / Family



### Materiales / Materials

Hierro - Vidrio borosilicato  
*Iron - Borosilicate glass*



### Drop A/01

Aplique / Wall Lamp

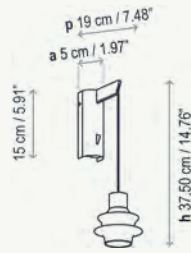

- 2590100756 Ébano Negro - Vidrio Transparente  
*Black Ebony - Transparent Glass*
- 2590100757 Ébano Negro - Vidrio Matizado  
*Black Ebony - Frosted Glass*
- 2590100758 Ébano Negro - Vidrio Verde  
*Black Ebony - Green Glass*
- 2590100759 Ébano Negro - Vidrio Azul  
*Black Ebony - Blue Glass*

Con interruptor / With switch

### Drop A/02

Aplique / Wall Lamp

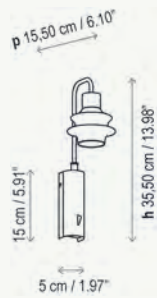

- 2590200756 Ébano Negro - Vidrio Transparente  
*Black Ebony - Transparent Glass*
- 2590200757 Ébano Negro - Vidrio Matizado  
*Black Ebony - Frosted Glass*
- 2590200758 Ébano Negro - Vidrio Verde  
*Black Ebony - Green Glass*
- 2590200759 Ébano Negro - Vidrio Azul  
*Black Ebony - Blue Glass*

Con interruptor / With switch

### Drop A/03

Aplique / Wall Lamp

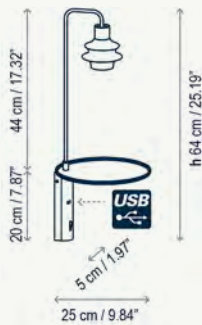

- 2590300756 Ébano Negro - Vidrio Transparente  
*Black Ebony - Transparent Glass*
- 2590300757 Ébano Negro - Vidrio Matizado  
*Black Ebony - Frosted Glass*
- 2590300758 Ébano Negro - Vidrio Verde  
*Black Ebony - Green Glass*
- 2590300759 Ébano Negro - Vidrio Azul  
*Black Ebony - Blue Glass*

Tejido interior de la bandeja en color marrón topo  
*The inside of the tray includes a taupe coated fabric*  
Capacidad carga de la bandeja : 2 Kg  
*Weight capacity of the tray: 2 Kg*  
Con interruptor / With switch

### Acabados Drip / Finishing Drip



Vidrio Transparente  
*Transparent Glass*

Vidrio Matizado  
*Frosted Glass*

Vidrio Verde  
*Green Glass*

Vidrio Azul  
*Blue Glass*

### Acabados Drop / Finishing Drop



Vidrio Transparente  
*Transparent Glass*

Vidrio Matizado  
*Frosted Glass*

Vidrio Verde  
*Green Glass*

Vidrio Azul  
*Blue Glass*

# Flexo

by Joana Bover | 2006



## Flexo

Aplique / Wall Lamp

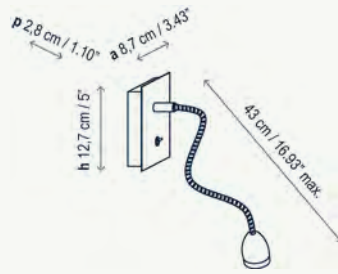

FL25106 Cromo / Chrome

FL25105 Níquel Satinado / Satin Nickel

Flexo realizado en latón para mayor flexibilidad y garantía de rigidez.  
Flexo made in brass to ensure greater flexibility and rigidity.

Flexo es adaptable a cualquier posición y permite focalizar el punto de luz hacia el lugar deseado sin que se produzcan deslumbramientos, la luz que emite es cálida.

*Flexo adapts to different positions and permits focusing light point to the desired place without creating a glare; the emitted light is warm.*



### Materiales / Materials

Latón - Hierro - Aluminio  
Brass - Iron - Aluminum

### Acabados / Finishing

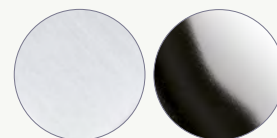

Níquel Satinado  
Satin Nickel

Cromo Brillante  
Brilliant Chrome

# Flexo Lexa

by Christophe Mathieu | 2008



## Flexo Lexa

Aplique / Wall Lamp

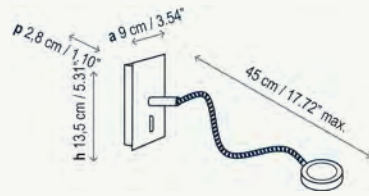

FL20505 Níquel Satinado / *Satin Nickel*

FL20506 Cromo Brillante / *Brilliant Chrome*

Flexo realizado en latón para mayor flexibilidad y garantía de rigidez.  
*Flexo made in brass to ensure greater flexibility and rigidity.*

Flexo Lexa es un aplique con altas prestaciones tanto decorativas como lumínicas. Su brazo es adaptable a cualquier posición y permite focalizar el punto de luz hacia el lugar deseado sin que se produzcan deslumbramientos, la luz que emite es cálida.

*Flexo Lexa is a high performance wall lamp that is both decorative and luminous. Its arm is adaptable to any position and allows you to focus the light point to the desired place without creating a glare; the emitted light is warm.*



### Materiales / *Materials*

Zamac - Latón  
Zamac - Brass

### Acabados / *Finishing*

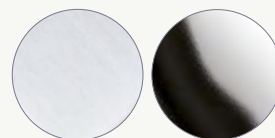

Níquel Satinado  
*Satin Nickel*

Cromo Brillante  
*Brilliant Chrome*

# Garota

by Alex Fernández Camps / Gonzalo Milà | 2015



## Garota A/01

Applique Interior  
Indoor Wall Lamp



1 x 46 W Classic P Eco E-27

1 x 6 W LED E-27 P48

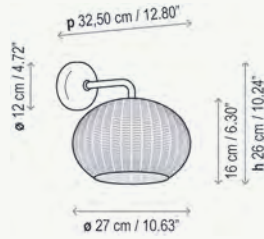

3350100001/P803 Blanco Roto - Pantalla Blanco Marfil  
*Natural White - Ivory White Shade*

3350100001/P804 Blanco Roto - Pantalla Marrón  
*Natural White - Brown Shade*

3350100003/P804 Marrón Grafito - Pantalla Marrón  
*Graphite Brown - Brown Shade*

3350100003/P803 Marrón Grafito - Pantalla Blanco Marfil  
*Graphite Brown - Ivory White Shad*

No incluye globo elipse / *Globe not included*

Garota, inspirada en el caparazón de un erizo de mar, nos ofrece una luz cálida y tamizada; envuelta en formas orgánicas, redondeadas y sutiles; pensada para acompañarnos en zonas de interior y exterior indistintamente.

*Garota, inspired by a sea urchin's shell, offers us a warm and dispersed light; wrapped in organic, rounded and subtle forms; designed to indistinctly accompany us in interior and exterior areas.*

### Familia Interior / Indoor Family

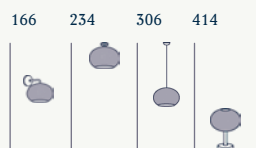

### Familia Exterior / Outdoor Family



### Materiales / Materials

Aluminio - Acero inoxidable - Polietileno - Fibra sintética  
*Aluminum - Stainless steel - Polyethylene - Synthetic fiber*

Todas las fibras sintéticas utilizadas por Bover son reciclables y no tóxicas para la sostenibilidad del medio ambiente

*All synthetic fibers used by Bover are recyclable and non-toxic for environmental sustainability.*

### Acabados / Finishing



# Klar

by Christophe Mathieu | 2006







Klar es un guiño a los 70', retro y funcional recuerda los camerinos de las estrellas de cine. Puede utilizarse tanto en pared como directamente en el techo.

*Klar is a wink to the 70's, retro and functional its design reminiscent of movie star dressing-rooms. It can be used both on the wall and directly on the ceiling.*



# Klar

Applique / Wall Lamp

|  |  | IP 54 | 230V | 50Hz |

|  |  |

|  | 1 x 48 W G-9 (Halopin Eco) |

|  | 1 x 3,5 W LED G-9 |

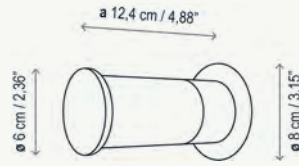

1125421

Cromo Cristal Opal / Chrome Opal Glass

## Materiales / Materials

Hierro - Aluminio - Vidrio borosilicato  
Iron - Aluminum - Borosilicate glass

## Acabados / Finishing

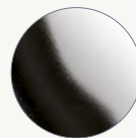

Cromo Brillante  
Brilliant Chrome

# Lea

by Alex Fernández Camps | 2009







**05**

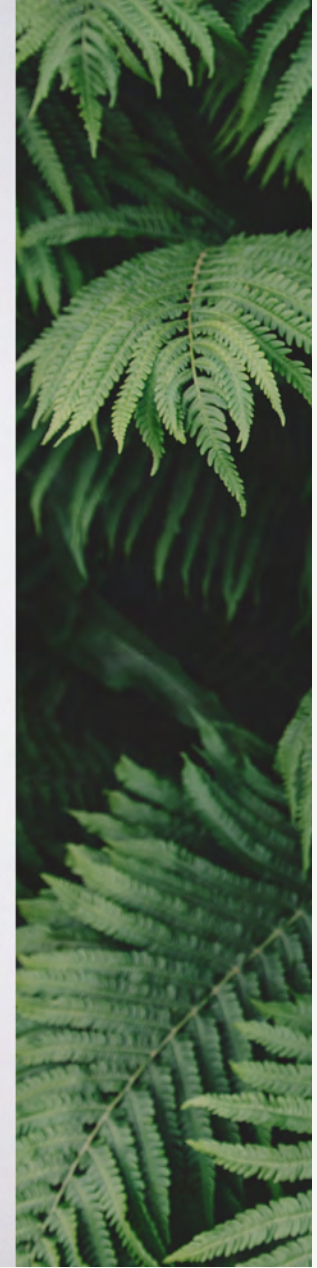

Lea es un aplique arquitectural, libre de ornamentos. Lea es una luz-lugar ya que dispone de una repisa en la parte superior que nos permite depositar libros o revistas, y al mismo tiempo ofrecernos una luz inferior de gran calidad lumínica. Una solución

geométrica pensada para cumplir una función particular en cada proyecto; recibidores, pasillos, mesas de estudio, mesas de restaurante, etc.

*Lea is an architectural wall lamp, free of ornaments. Lea is a light-space because it has a shelf at the top that allow us to place books and magazines, and at the same time offer us a*

*lower light of great quality. A geometric solution designed to fulfill a particular function in each project: for entrances, along aisles, in front of study tables, on restaurant tables, etc.*





Interruptor opcional / Consultar  
*Optional switch / Consult*



## Lea

Aplique / Wall Lamp

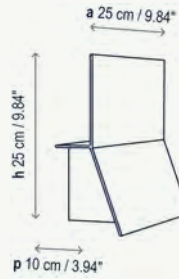

0021501

Blanco / White

## Lea 01

Aplique / Wall Lamp

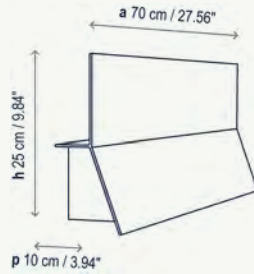

0121501

Blanco / White

\*D0121501

Regulable Sistema DALI / Blanco  
DALI Dimming System / White

## Lea 02

Aplique / Wall Lamp

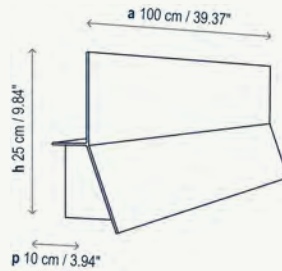

0221501

Blanco / White

\*D0221501

Regulable Sistema DALI / Blanco  
DALI Dimming System / White

## Lea 03

Aplique / Wall Lamp

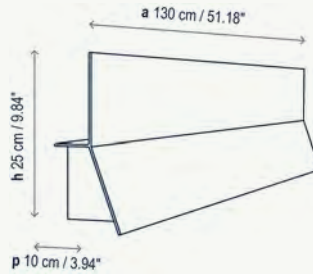

0321501

Blanco / White

\*D0321501

Regulable Sistema DALI / Blanco  
DALI Dimming System / White

Estante superior hasta 4 kg / Upper shelf holds up to 4 kg

### Difusor / Diffuser

Polycarbonato  
Polycarbonate

### Materiales / Materials

Aluminio  
Aluminum

### Acabados / Finishing



Blanco Lea  
Lea White

Colores especiales. Cantidad mínima:  
5 unidades.  
Special colors. Minimum quantity:  
5 pieces.

# Lexa

by Joana Bover | 2008



Lexa es una colección de apliques básicos, fuertes y elegantes, que encajan con facilidad en cualquier ambiente intemporal. Pueden incorporar interruptor y distintas opciones de pantalla que modifican su aspecto formal.

*Lexa is a collection of basic wall sconces, strong yet elegant, that fit easily into any type of any timeless setting. They can incorporate a switch and different screen options that modify their formal appearance.*



## Lexa

Aplique / Wall Lamp



1 x 46 W Classic P Eco E-27

1 x 11 W E-27

1 x 6 W LED E-27 P48

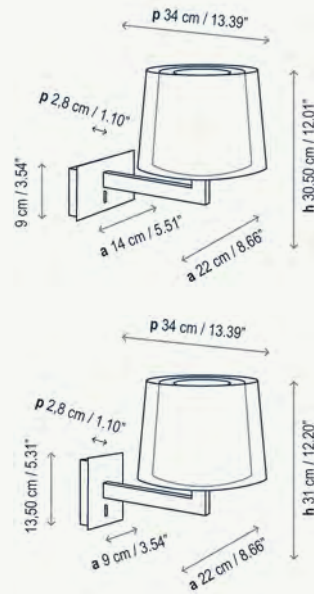

### Caja Horizontal Horizontal Backplate-Box

1320505/P634E Níquel Satinado - Cinta Translúcida Blanca  
*Satin Nickel - White Translucent Ribbon*

1320505/P635E Níquel Satinado - Cinta Translúcida Crema  
*Satin Nickel - Cream Translucent Ribbon*

1320505/P633E Níquel Satinado - Cotonet Blanco  
*Satin Nickel - White Cotton*

1320505/P636E/P636I  
Níquel Satinado  
Pantalla Interior y Exterior Malla Negra  
*Horizontal - Satin Nickel  
Outer & Inner Lampshade Black Mesh*

1320505 /P637E/P637I  
Níquel Satinado  
Pantalla Interior y Exterior Malla Roja  
*Horizontal - Satin Nickel  
Outer & Inner Lampshade Red Mesh*

### Caja Vertical Vertical Backplate-Box

1120505/P634E Níquel Satinado - Cinta Translúcida Blanca  
*Satin Nickel - White Translucent Ribbon*

1120505/P635E Níquel Satinado - Cinta Translúcida Crema  
*Satin Nickel - Cream Translucent Ribbon*

1120505/P633E Níquel Satinado - Cotonet Blanco  
*Satin Nickel - White Cotton*

1120505/P636E/P636I  
Níquel Satinado  
Pantalla Interior y Exterior Malla Negra  
*Satin Nickel  
Outer & Inner Lampshade Black Mesh*

1120505/P637E/P637I  
Níquel Satinado  
Pantalla Interior y Exterior Malla Roja  
*Satin Nickel  
Outer & Inner Lampshade Red Mesh*



Caja Horizontal  
Horizontal Backplate-Box

- 1320506/P634E Cromo Brillante - Cinta Translúcida Blanca  
Brilliant Chrome - White Translucent Ribbon
- 1320506/P635E Cromo Brillante - Cinta Translúcida Crema  
Brilliant Chrome - Cream Translucent Ribbon
- 1320506/P633E Cromo Brillante - Cotonet Blanco  
Brilliant Chrome - White Cotton
- 1320506/P636E/P636I  
Cromo Brillante  
Pantalla Interior i Exterior Malla Negra  
Brilliant Chrome  
Outer & Inner Lampshade Black Mesh
- 1320506 /P637E/P637I  
Cromo Brillante  
Pantalla Interior i Exterior Malla Roja  
Brilliant Chrome  
Outer & Inner Lampshade Red Mesh

Caja Vertical  
Vertical Backplate-Box

- 1120506/P634E Cromo Brillante - Cinta Translúcida Blanca  
Brilliant Chrome - White Translucent Ribbon
- 1120506/P635E Cromo Brillante - Cinta Translúcida Crema  
Brilliant Chrome - Cream Translucent Ribbon
- 1120506/P633E Cromo Brillante - Cotonet Blanco  
Brilliant Chrome - White Cotton
- 1120506/P636E/P636I  
Cromo Brillante  
Pantalla Interior i Exterior Malla Negra  
Brilliant Chrome  
Outer & Inner Lampshade Black Mesh
- 1120506/P637E/P637I  
Cromo Brillante  
Pantalla Interior i Exterior Malla Roja  
Brilliant Chrome  
Outer & Inner Lampshade Red Mesh

Pantalla Exterior : 22 x 16 x 18 cm  
Outer lampshade 8.66" x 6.30" x 7.09"

Materiales / Materials

Latón - Hierro  
Brass - Iron

Acabados / Finishing



Níquel Satinado  
Satin Nickel

Cromo Brillante  
Brilliant Chrome

Malla Negra  
Black Mesh

Malla Roja  
Red Mesh

Cinta Crema  
Cream Ribbon

Cinta Blanca  
White Ribbon

Cotonet Blanco  
White Cotton

# Lexa FL

by Joana Bover / Christophe Mathieu | 2008





Lexa Flexo pensado como lámpara de cabecera, incorpora un led realizado en inyección de aluminio que permite una fácil orientación del cabezal en todos los sentidos gracias a la malla flexible que lo sujeta y une al cuerpo central.

*Lexa Flexo, designed as a reading lamp, features an aluminum injection LED and the head can be moved in all directions thanks to the flexible mesh attaching it to the central body.*

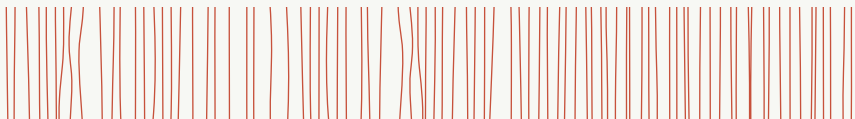

## Lexa FL

Aplique / Wall Lamp



1 x 46 W Classic P Eco E-27

1 x 11 W E-27

1 x 6 W LED E-27 P48

1,2 W LED / 45°  
85 lm / CRI: 90 / 2900° K

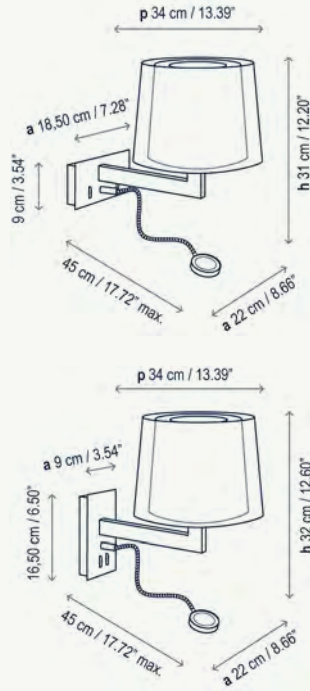

### Caja Horizontal

Horizontal Backplate-Box

1020505/P634E Níquel Satinado - Cinta Translúcida Blanca  
*Satin Nickel - White Translucent Ribbon*

1020505/P635E Níquel Satinado - Cinta Translúcida Crema  
*Satin Nickel - Cream Translucent Ribbon*

1020505/P633E Níquel Satinado - Cotonet Blanco  
*Satin Nickel - White Cotton*

1020505/P636E/P636I  
Níquel Satinado  
Pantalla Interior i Exterior Malla Negra  
*Satin Nickel  
Outer & Inner Lampshade Black Mesh*

1020505 /P637E/P637I  
Níquel Satinado  
Pantalla Interior i Exterior Malla Roja  
*Satin Nickel  
Outer & Inner Lampshade Red Mesh*

### Caja Vertical

Vertical Backplate-Box

1220505 /P634E Níquel Satinado - Cinta Translúcida Blanca  
*Satin Nickel - White Translucent Ribbon*

1220505/P635E Níquel Satinado - Cinta Translúcida Crema  
*Satin Nickel - Cream Translucent Ribbon*

1220505/P633E Níquel Satinado - Cotonet Blanco  
*Satin Nickel - White Cotton*

1220505/P636E/P636I  
Níquel Satinado  
Pantalla Interior i Exterior Malla Negra  
*Satin Nickel  
Outer & Inner Lampshade Black Mesh*

1220505/P637E/P637I  
Níquel Satinado  
Pantalla Interior i Exterior Malla Roja  
*Satin Nickel  
Outer & Inner Lampshade Red Mesh*





Caja Horizontal

Horizontal Backplate-Box

- 1020506/P634E Cromo Brillante - Cinta Translúcida Blanca  
*Brilliant Chrome - White Translucent Ribbon*
- 1020506/P635E Cromo Brillante - Cinta Translúcida Crema  
*Brilliant Chrome - Cream Translucent Ribbon*
- 1020506/P633E Cromo Brillante - Cotonet Blanco  
*Brilliant Chrome - White Cotton*
- 1020506/P636E/P636I  
Cromo Brillante  
Pantalla Interior i Exterior Malla Negra  
*Brilliant Chrome  
Outer & Inner Lampshade Black Mesh*
- 1020506 /P637E/P637I  
Cromo Brillante  
Pantalla Interior i Exterior Malla Roja  
*Brilliant Chrome  
Outer & Inner Lampshade Red Mesh*

Caja Vertical

Vertical Backplate-Box

- 1220506/P634E Cromo Brillante - Cinta Translúcida Blanca  
*Brilliant Chrome - White Translucent Ribbon*
- 1220506/P635E Cromo Brillante - Cinta Translúcida Crema  
*Brilliant Chrome - Cream Translucent Ribbon*
- 1220506/P633E Cromo Brillante - Cotonet Blanco  
*Brilliant Chrome - White Cotton*
- 1220506/P636E/P636I  
Cromo Brillante  
Pantalla Interior i Exterior Malla Negra  
*Brilliant Chrome  
Outer & Inner Lampshade Black Mesh*
- 1220506/P637E/P637I  
Cromo Brillante  
Pantalla Interior i Exterior Malla Roja  
*Brilliant Chrome  
Outer & Inner Lampshade Red Mesh*

Pantalla Exterior : 22 x 16 x 18 cm  
*Outer lampshade 8.66" x 6.30" x 7.09"*

Flexo de latón para asegurar una mayor flexibilidad y rigidez  
*Flexo made in brass to ensure greater flexibility and rigidity*

Materiales / Materials

Latón - Zamac - Hierro  
*Brass - Zamac - Iron*

Acabados / Finishing



Níquel Satinado  
*Satin Nickel*



Cromo Brillante  
*Brilliant Chrome*

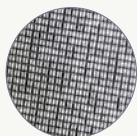

Malla Negra  
*Black Mesh*



Malla Roja  
*Red Mesh*

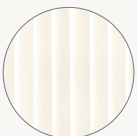

Cinta Crema  
*Cream Ribbon*



Cinta Blanca  
*White Ribbon*



Cotonet Blanco  
*White Cotton*

# Liban

by Lluís Porqueras / Cristian Diez | 2003



## Liban

Aplique / Wall Lamp



1 x 120 W R7S 118 mm

1 x 8 W LED R7S 118 mm

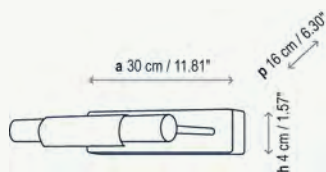

1118605 Níquel Satinado / *Satin Nickel*

1118606 Cromo Brillante / *Brilliant Chrome*

De aspecto sobrio y funcional, Liban ofrece una luz directa sobre el objeto que queremos resaltar. La pantalla difusora de luz permite un leve posicionamiento.

*Liban is a serious and functional wall light which offers direct illumination on the object we need to enhance. The shade can be slightly adjusted.*

### Materiales / *Materials*

Latón - Hierro  
*Brass - Iron*

### Acabados / *Finishing*

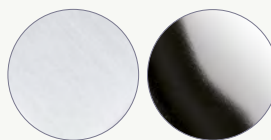

Níquel Satinado  
*Satin Nickel*

Cromo Brillante  
*Brilliant Chrome*

# Nón Lá

by Jorge Pensi Design Studio | 2015









Nón lá es nuestra manera de rendirle un pequeño homenaje al sombrero vietnamita y a su cultura centenaria. Su sencillo cono abierto, nos ofrece una estructura ligera, resistente y un punto vanguardista gracias a la descentralidad de su cavidad lumínica. Su brazo de fundición de hierro en forma de ángulo nos ofrece un aspecto más rudo que contrasta con la sutileza de su pantalla cónica.

*Non La is our way of paying a little homage to the Vietnamese hat and its centenary culture. Its simple open cone offers us a light structure that is resistant and a bit avant-garde, thanks to the decentralization of its light cavity. Its cast iron arm in the shape of an angle gives it a rough look that contrasts with the subtlety of its conical shade.*





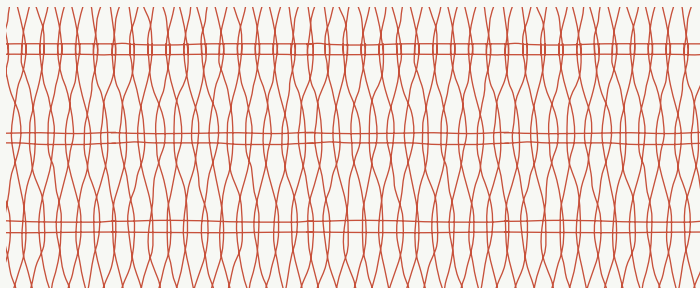
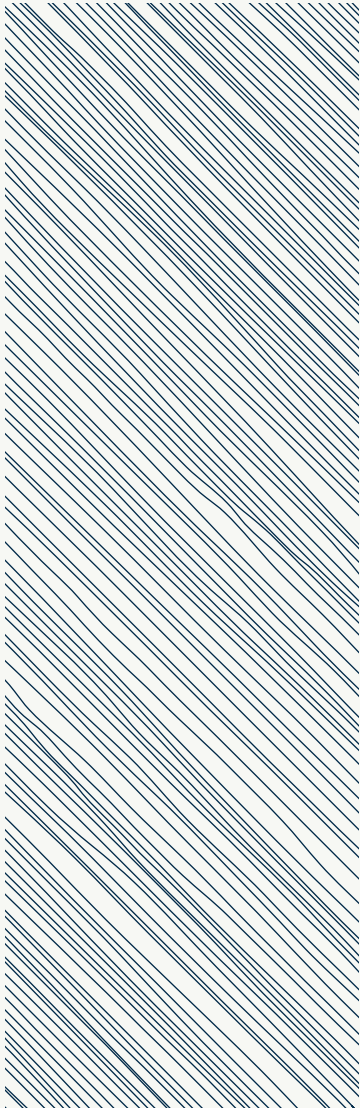

## Nón Lá A/01

Aplique / Wall Lamp

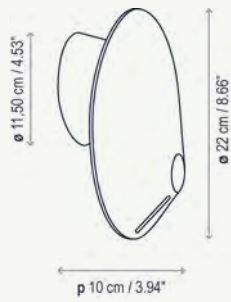

- 3320100601 Blanco Lacado Brillante / *White Brilliant Lacquer*
- 3320100606 Cromo / *Chrome*
- 3320100690 Cobre Brillante / *Brilliant Copper*

---

- \*3320101301 Dimable TRIAC - Blanco Lacado Brillante  
*Dimmable TRIAC - White Brilliant Lacquer*
- \*3320101306 Dimable TRIAC - Cromo  
*Dimmable TRIAC - Chrome*
- \*3320101390 Dimable TRIAC - Cobre Brillante  
*Dimmable TRIAC - Brilliant Copper*

## Nón Lá A/02

Aplique / Wall Lamp

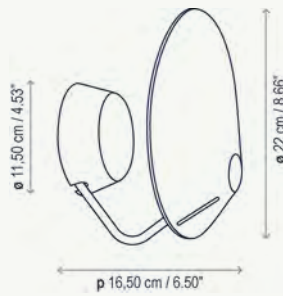

- 3320200601 Blanco Lacado Brillante / *White Brilliant Lacquer*
- 3320200606 Cromo / *Chrome*
- 3320200690 Cobre Brillante / *Brilliant Copper*

---

- \*3320201301 Dimable TRIAC - Blanco Lacado Brillante  
*Dimmable TRIAC - White Brilliant Lacquer*
- \*3320201306 Dimable TRIAC - Cromo  
*Dimmable TRIAC - Chrome*
- \*3320201390 Dimable TRIAC - Cobre Brillante  
*Dimmable TRIAC - Brilliant Copper*

## Familia / Family

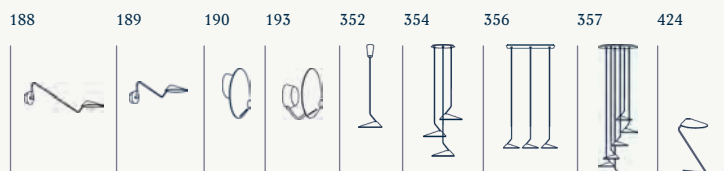

## Nón Lá A/03

Aplique / Wall Lamp

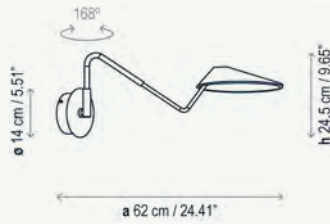

3320301301 Dimable TRIAC - Blanco Lacado Brillante  
*Dimmable TRIAC - White Brilliant Lacquer*

3320301306 Dimable TRIAC - Cromo  
*Dimmable TRIAC - Chrome*

3320301390 Dimable TRIAC - Cobre Brillante  
*Dimmable TRIAC - Brilliant Copper*

3320301601 Blanco Lacado Brillante + Interruptor,  
*White Brilliant Lacquer + Switch*

3320301606 Cromo + Interruptor  
*Chrome + Switch*

3320301690 Cobre Brillante + Interruptor  
*Brilliant Copper + Switch*

Proxy dimmer interruptor  
*Proxy dimmer switch*

El brazo es de color negro grafito.  
*Arm in Black Graphite.*

## Nón Lá A/04

Aplique / Wall Lamp

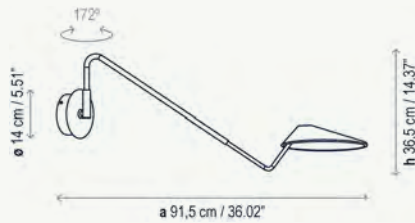

3320401301 Dimable TRIAC - Blanco Lacado Brillante  
*Dimmable TRIAC - White Brilliant Lacquer*

3320401306 Dimable TRIAC - Cromo  
*Dimmable TRIAC - Chrome*

3320401390 Dimable TRIAC - Cobre Brillante  
*Dimmable TRIAC - Brilliant Copper*

3320401601 Blanco Lacado Brillante + Interruptor  
*White Brilliant Lacquer + Switch*

3320401606 Cromo + Interruptor  
*Chrome + Switch*

3320401690 Cobre Brillante + Interruptor  
*Brilliant Copper + Switch*

Proxy dimmer interruptor  
*Proxy dimmer switch*

El brazo es de color negro grafito.  
*Arm in Black Graphite.*

### Materiales / Materials

Aluminio - Hierro fundido  
*Aluminum - Molten Iron*

### Difusor / Diffuser

Metacrilato  
*Methacrylate*

### Acabados / Finishing

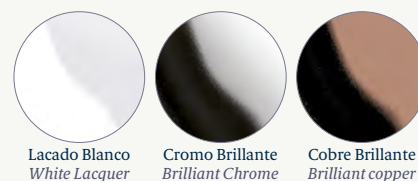

Lacado Blanco  
*White Lacquer*

Cromo Brillante  
*Brilliant Chrome*

Cobre Brillante  
*Brilliant copper*

# Oval

by Joana Bover | 2007





La colección Oval se completa con las versiones de pared, sobremesa y pie que incorporan a la base metálica detalles de vidrio aportando sofisticación.

*The Oval collection is complete with wall, table and floor versions that incorporate glass adding sophistication to the metal base.*



## Oval A/01

Aplique / Wall Lamp



1 x 46 W Classic P Eco E-27

1 x 11 W E-27  
Duluxstar Mini Twist

1 x 6 W LED E-27 P48

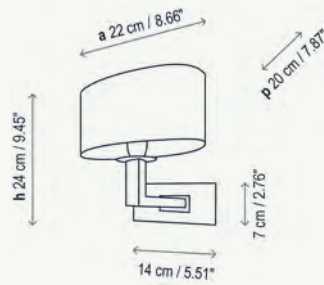

Pantalla oval 21 x 14 x 13 cm (sin difusor)  
Oval lampshade 8.27" x 5.51" x 5.12" (without diffuser)

- |              |   |
|--------------|---|
| 0125006/P600 | Cromo Brillante - Cinta Translúcida Blanca<br><i>Brilliant Chrome - White Translucent Ribbon</i>                                  |
| 0125006/P601 | Cromo Brillante - Cinta Translúcida Crema<br><i>Brilliant Chrome - Cream Translucent Ribbon</i>                                   |
| 0125006/P602 | Cromo Brillante - Cinta Translúcida Negra<br><i>Brilliant Chrome - Black Translucent Ribbon</i>                                   |
| 0125006/P603 | Cromo Brillante - Cotonet Blanco<br><i>Brilliant Chrome - White Cotton</i>  |
| 0125017/P600 | Cromo Brillante - Cristal Negro<br>Cinta Translúcida Blanca<br><i>Brilliant Chrome - Black Glass<br/>White Translucent Ribbon</i> |
| 0125017/P601 | Cromo Brillante - Cristal Negro<br>Cinta Translúcida Crema<br><i>Brilliant Chrome - Black Glass<br/>Cream Translucent Ribbon</i>  |
| 0125017/P602 | Cromo Brillante - Cristal Negro<br>Cinta Translúcida Negra<br><i>Brilliant Chrome - Black Glass<br/>Black Translucent Ribbon</i>  |
| 0125017/P603 | Cromo Brillante - Cristal Negro<br>Cotonet Blanco<br><i>Brilliant Chrome - Black Glass - White Cotton</i>                         |
| 0125005/P600 | Níquel Satinado - Cinta Translúcida Blanca<br><i>Satin Nickel - White Translucent Ribbon</i>                                      |
| 0125005/P601 | Níquel Satinado - Cinta Translúcida Crema<br><i>Satin Nickel - Cream Translucent Ribbon</i>                                       |
| 0125005/P602 | Níquel Satinado - Cinta Translúcida Negra<br><i>Satin Nickel - Black Translucent Ribbon</i>                                       |
| 0125005/P603 | Níquel Satinado - Cotonet Blanco<br><i>Satin Nickel - White Cotton</i>  |

## Oval A/02

Aplique / Wall Lamp



1 x 46 W Classic P Eco E-27

1 x 11 W E-27  
Duluxstar Mini Twist

1 x 6 W LED E-27 P48

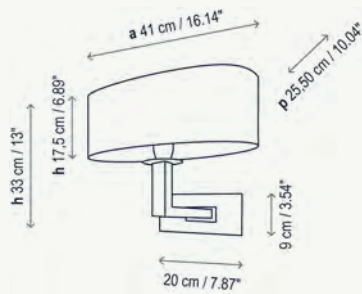

Pantalla oval 41 x 17,5 x 15 cm (sin difusor)  
Oval lampshade 16.14" x 6.89" x 5.91" (without diffuser)

1125005/P551 Níquel Satinado - Cinta Translúcida Blanca  
Satin Nickel - White Translucent Ribbon

1125005/P552 Níquel Satinado - Cinta Translúcida Crema  
Satin Nickel - Cream Translucent Ribbon

1125005/P553 Níquel Satinado - Cinta Translúcida Negra  
Satin Nickel - Black Translucent Ribbon

1125005/P554 Níquel Satinado - Cotonet Blanco  
Satin Nickel - White Cotton

1125006/P551 Cromo Brillante - Cinta Translúcida Blanca  
Brilliant Chrome - White Translucent Ribbon

1125006/P552 Cromo Brillante - Cinta Translúcida Crema  
Brilliant Chrome - Cream Translucent Ribbon

1125006/P553 Cromo Brillante - Cinta Translúcida Negra  
Brilliant Chrome - Black Translucent Ribbon

1125006/P554 Cromo Brillante - Cotonet Blanco  
Brilliant Chrome - White Cotton

1125017/P551 Cromo Brillante - Cristal Negro  
Cinta Translúcida Blanca  
Brilliant Chrome - Black Glass  
White Translucent Ribbon

1125017/P552 Cromo Brillante - Cristal Negro  
Cinta Translúcida Crema  
Brilliant Chrome - Black Glass  
Cream Translucent Ribbon

1125017/P553 Cromo Brillante - Cristal Negro  
Cinta Translúcida Negra  
Brilliant Chrome - Black Glass  
Black Translucent Ribbon

1125017/P554 Cromo Brillante - Cristal Negro  
Cotonet Blanco  
Brilliant Chrome - Black Glass - White Cotton

## Familia / Family



## Difusor / Diffuser

Superior: Cristal Negro  
Upper: Black Glass



Pantalla oval 41 x 17,5 x 15 cm (con difusor)  
Oval lampshade 16.14" x 6.89" x 5.91" (with diffuser)

1125005/P551D Níquel Satinado - Cinta Translúcida Blanca  
Satin Nickel - White Translucent Ribbon

1125005/P552D Níquel Satinado - Cinta Translúcida Crema  
Satin Nickel - Cream Translucent Ribbon

1125005/P553D Níquel Satinado - Cinta Translúcida Negra  
Satin Nickel - Black Translucent Ribbon

1125005/P554D Níquel Satinado - Cotonet Blanco  
Satin Nickel - White Cotton

1125006/P551D Cromo Brillante - Cinta Translúcida Blanca  
Brilliant Chrome - White Translucent Ribbon

1125006/P552D Cromo Brillante - Cinta Translúcida Crema  
Brilliant Chrome - Cream Translucent Ribbon

1125006/P553D Cromo Brillante - Cinta Translúcida Negra  
Brilliant Chrome - Black Translucent Ribbon

1125006/P554D Cromo Brillante - Cotonet Blanco  
Brilliant Chrome - White Cotton

1125017/P551D Cromo Brillante - Cristal Negro  
Cinta Translúcida Blanca  
Brilliant Chrome - Black Glass  
White Translucent Ribbon

1125017/P552D Cromo Brillante - Cristal Negro  
Cinta Translúcida Crema  
Brilliant Chrome - Black Glass  
Cream Translucent Ribbon

1125017/P553D Cromo Brillante - Cristal Negro  
Cinta Translúcida Negra  
Brilliant Chrome - Black Glass  
Black Translucent Ribbon

1125017/P554D Cromo Brillante - Cristal Negro - Cotonet Blanco  
Brilliant Chrome - Black Glass - White Cotton

La pantalla con difusor solo admite bombillas Eco-Classic.  
NO son aptas las bombillas compactas.  
Shade with upper diffuser only suitable with Eco-Classic bulbs.  
NOT suitable with compact bulbs.

## Materiales / Materials

Latón - Cristal  
Brass - Glass

## Acabados / Finishing

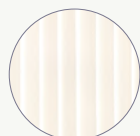

Cinta Crema  
Cream Ribbon



Cinta Blanca  
White Ribbon



Cinta Negra  
Black Ribbon



Cotonet Blanco  
White Cotton



Níquel Satinado  
Satin Nickel



Cromo Brillante  
Brilliant Chrome

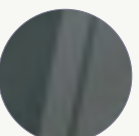

Cristal Negro  
Black Glass

202 |

# Plana

by Christophe Mathieu | 2004





Plana es un aplique  
minimalista.  
Sus líneas rectas  
y estilizadas le  
confieren un  
marcado acento  
contemporáneo.

*Plana is a  
minimalist wall  
lamp. Its straight  
and stylized lines  
give it a marked  
contemporary  
accent.*



### Plana 01

Aplique / Wall Lamp



 1 x 80 W R7S 78 mm

 1 x 6 W LED R7S 78 mm

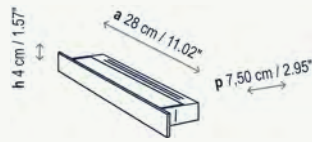

1119805

Níquel Satinado / *Satin Nickel*

1119806

Cromo Brillante / *Brilliant Chrome*

### Plana 02

Aplique / Wall Lamp



 2 x 80 W R7S 78 mm

 2 x 6 W LED R7S 78 mm



1219805

Níquel Satinado / *Satin Nickel*

1219806

Cromo Brillante / *Brilliant Chrome*

### Plana T5

Aplique / Wall Lamp



 2 x 24 W T5

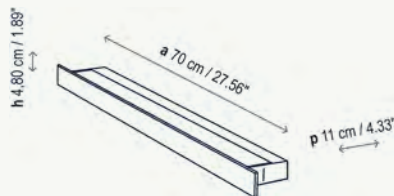

T519805

Níquel Satinado / *Satin Nickel*

T519806

Cromo Brillante / *Brilliant Chrome*

#### Material / Materials

Plana 01 - 02  
Acero inoxidable 304  
*304 Stainless steel*

Plana T5  
Hierro  
*Iron*

#### Difusores / Diffusers

Plana 01 - 02  
Cristal templado  
*Tempered glass*

Plana T5  
Metacrilato  
*Methacrylate*

#### Acabados / Finishing

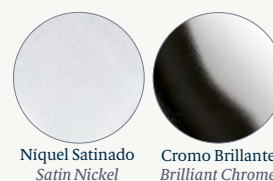

Níquel Satinado  
*Satin Nickel*

Cromo Brillante  
*Brilliant Chrome*

# Spock

by Christophe Mathieu | 2007



## Spock A

Aplique / Wall Lamp

230V  
50Hz



4,8 W LED / 4 x 1,2 W = 4,8 W  
85 x 4 = 340 lm / CRI: 90 / 2900° K

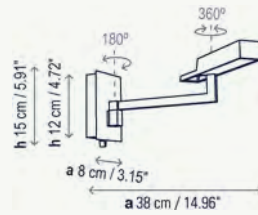

1110505L Níquel / Nickel  
1110506L Cromo / Chrome  
1110511L Cromo-Blanco / Chrome-White

Con interruptor / With switch

Spock tiene un aspecto de gran ligereza; han sido pensadas y producidas utilizando un lenguaje de diseño simple, fácil y cercano. La estructura de la pantalla es orientable y el cabezal tiene una rotación circular de 360°.

*Spock has a very light appearance, and it has been created using simple, easy and clean design language. The structure of the shade is adjustable, the head has 360° circular rotation.*

### Materiales / Materials

Zamac - Hierro - Acero inoxidable 304 - Latón  
Zamac - Iron - 304 Stainless steel - Brass

### Difusor / Diffuser

Policarbonato  
Polycarbonate

### Acabados / Finishing

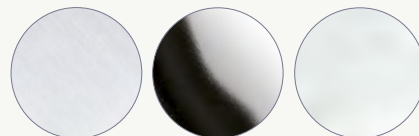

Níquel Satinado  
Satin Nickel

Cromo Brillante  
Brilliant Chrome

Cromo Blanco  
White Chrome

### Familia / Family

206

432

432

456



# Tria

by Rubén Saldaña | 2016







*Hotel Barceló Atenea / Barcelona*





La forma orgánica y modular hace de Tria un objeto singular y original. Tria nos permite instalarlo como aplique individual o por módulos con un solo punto de conexión en pared, facilitando su aplicación como mural en recepciones, pasillos, etc.

*Its organic and modular shape makes Tria a unique and original object. Tria can be installed either as a single wall light or as a light module with a sole connection point on the wall which makes it easier to be displayed as a mural at hotel reception desks, corridors, etc.*





## Tria 01

Aplique / Wall Lamp



230V  
50Hz

8,7 W LED / 24 x 0,36 W = 8,7 W  
960 lm / CRI: 90 / 2700° K

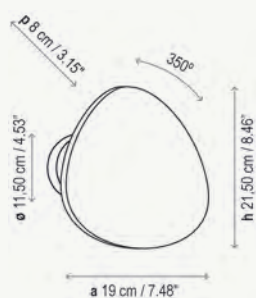

2080100601 Blanco Lacado Satinado / *White Satin Lacquer*

2080100635 Roble Natural / *Natural Oak*

## Tria 02

Aplique / Wall Lamp



230V  
50Hz

13 W LED / 36 x 0,36 W = 13 W  
1440 lm / CRI: 90 / 2700° K

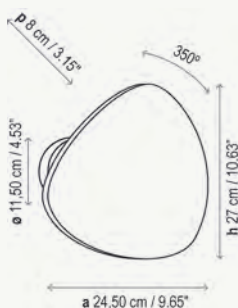

2080200601 Blanco Lacado Satinado / *White Satin Lacquer*

2080200635 Roble Natural / *Natural Oak*

\*2080201301 Dimable TRIAC - Blanco Lacado Satinado  
*Dimmable TRIAC - White Satin Lacquer*

\*2080201335 Dimable TRIAC - Roble Natural  
*Dimmable TRIAC - Natural Oak*

## Tria 03

Aplique / Wall Lamp



230V  
50Hz

17 W LED / 48 x 0,36 W = 17 W  
1920 lm / CRI: 90 / 2700° K

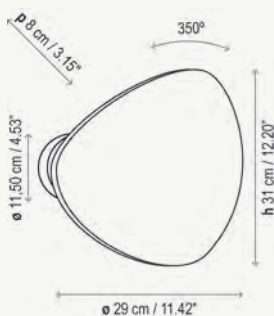

2080300601 Blanco Lacado Satinado / *White Satin Lacquer*

2080300635 Roble Natural / *Natural Oak*

\*2080301401 Dimable TRIAC - Blanco Lacado Satinado  
*Dimmable TRIAC - White Satin Lacquer*

\*2080301435 Dimable TRIAC - Roble Natural  
*Dimmable TRIAC - Natural Oak*

### Tria Set 3

Aplique / Wall Lamp

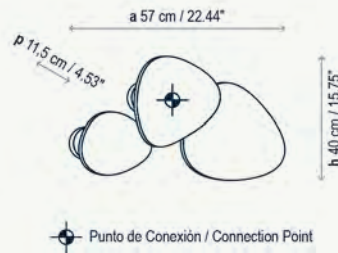

- 2081300601 Blanco Lacado Satinado / *White Satin Lacquer*
- 2081300635 Roble Natural / *Natural Oak*
- 2081300619 Blanco-Roble-Blanco / *White-Natural Oak-White*
- \*2081301301 Dimable TRIAC - Blanco Lacado Satinado  
*Dimmable TRIAC - White Satin Lacquer*
- \*2081301335 Dimable TRIAC - Roble Natural  
*Dimmable TRIAC - Natural Oak*
- \*2081301319 Dimable TRIAC - Blanco-Roble-Blanco  
*Dimmable TRIAC - White-Natural Oak-White*

### Tria Set 6

Aplique / Wall Lamp

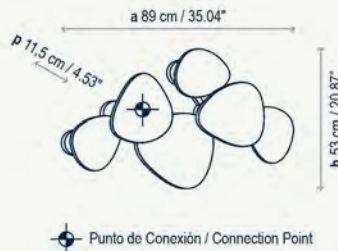

- 2081600601 Blanco Lacado Satinado / *White Satin Lacquer*
- 2081600635 Roble Natural / *Natural Oak*
- \*2081601301 Dimable TRIAC - Blanco Lacado Satinado  
*Dimmable TRIAC - White Satin Lacquer*
- \*2081601335 Dimable TRIAC - Roble Natural  
*Dimmable TRIAC - Natural Oak*

### Tria Set 8

Aplique / Wall Lamp

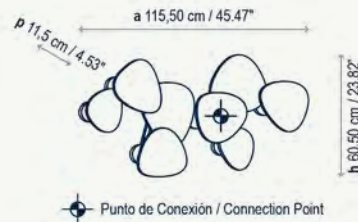

- 2081800601 Blanco Lacado Satinado / *White Satin Lacquer*
- 2081800635 Roble Natural / *Natural Oak*
- \*2081801301 Dimable TRIAC - Blanco Lacado Satinado  
*Dimmable TRIAC - White Satin Lacquer*
- \*2081801335 Dimable TRIAC - Roble Natural  
*Dimmable TRIAC - Natural Oak*

Frontal orientable / *Adjustable frontal*  
 Frontal de madera / *Wood frontal*  
 1 Punto de conexión / *1 Connection point*

#### Materiales / *Materials*

Madera acabado roble - Aluminio  
*Wood finished oak - Aluminum*

#### Acabados / *Finishing*

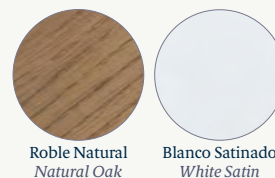

# Twall

by Christophe Mathieu | 2004







Este aplique nos ofrece una luz clara y directa. Está pensado para iluminar escaleras, pasillos o zonas de paso donde sea necesario no sobresalir más de 10 cm.

*This wall lamp offers a clear and direct light. It is designed to illuminate stairwells, corridors or walkways where projection of no more than 10 cm is required.*



## Twall

Aplique / Wall Lamp



2 x 60 W G-9 (Halopin Eco)

2 x 3,5 W LED G-9

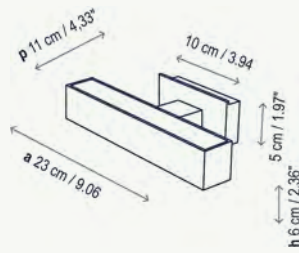

1119705

Níquel Satinado / *Satin Nickel*

1119706

Cromo Brillante / *Brilliant Chrome*

## Twall LED

Aplique / Wall Lamp



8,2 W LED / 24 x 0,34 W = 8,2 W  
840 lm / CRI: 90 / 2700° K

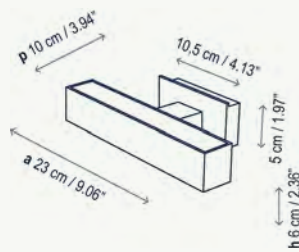

1970101305

Dimable TRIAC - Níquel Satinado  
*Dimmable TRIAC - Satin Nickel*

1970101306

Dimable TRIAC - Cromo Brillante  
*Dimmable TRIAC - Brilliant Chrome*

1970101365

Dimable TRIAC - Blanco  
*Dimmable TRIAC - White*

### Material / Materials

Acero inoxidable 304  
*304 Stainless steel*

### Difusores / Diffusers

Cristal templado  
*Tempered glass*

### Acabados / Finishing



Níquel Satinado  
*Satin Nickel*

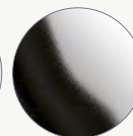

Cromo Brillante  
*Brilliant Chrome*

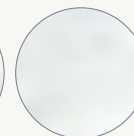

Blanco  
*White*

# Wall Street

by Joana Bover | 2000





Programa básico y funcional de apliques decorativos que facilitan una óptima difusión de la luz, gracias a la pantalla hecha a mano con cinta o algodón.

*Basic and functional collection of decorative wall lamps which do grant an optimal light diffusion thanks it hand wrapped ribbon or cotton fabric shade.*



## Wall Street

Aplique / Wall Lamp



1 x 30 W Classic P Eco E-27

1 x 14 W E-27

1 x 6 W LED E-27 P48

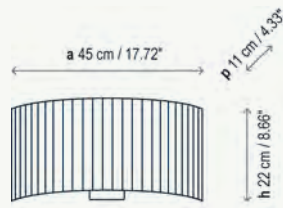

1118505/P299 Níquel Satinado - Cinta Translúcida Blanca  
*Satin Nickel - White Translucent Ribbon*

1118505/P298 Níquel Satinado - Cinta Translúcida Crema  
*Satin Nickel - Cream Translucent Ribbon*

1118505/P297 Níquel Satinado - Cotonet Blanco  
*Satin Nickel - White Cotton*

1118505/P296 Níquel Satinado - Cotonet  
*Satin Nickel - Cotton*

1118505/P295 Níquel Satinado - Plisada  
*Satin Nickel - Pleated*

Caja soporte 8 x 5 cm / Surface back box 3.15" x 1.97"

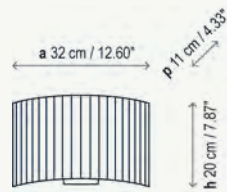

1118505/P334 Níquel Satinado - Cinta Translúcida Blanca  
*Satin Nickel - White Translucent Ribbon*

1118505/P333 Níquel Satinado - Cinta Translúcida Crema  
*Satin Nickel - Cream Translucent Ribbon*

1118505/P332 Níquel Satinado - Cotonet Blanco  
*Satin Nickel - White Cotton*

1118505/P339 Níquel Satinado - Cotonet  
*Satin Nickel - Cotton*

1118505/P338 Níquel Satinado - Plisada  
*Satin Nickel - Pleated*

Caja soporte 8 x 5 cm / Surface back box 3.15" x 1.97"



1 x 30 W Classic P Eco E-27

1 x 8 W E-27  
Duluxstar Mini Twist

1 x 6 W LED E-27 P48

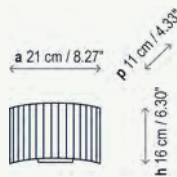

1118505/P356 Níquel Satinado - Cinta Translúcida Blanca  
*Satin Nickel - White Translucent Ribbon*

1118505/P355 Níquel Satinado - Cinta Translúcida Crema  
*Satin Nickel - Cream Translucent Ribbon*

1118505/P342 Níquel Satinado - Cotonet Blanco  
*Satin Nickel - White Cotton*

1118505/P347 Níquel Satinado - Cotonet  
*Satin Nickel - Cotton*

1118505/P346 Níquel Satinado - Plisada  
*Satin Nickel - Pleated*

Caja soporte 8 x 5 cm / Surface back box 3.15" x 1.97"

## Wall Street FL

Aplique / Wall Lamp

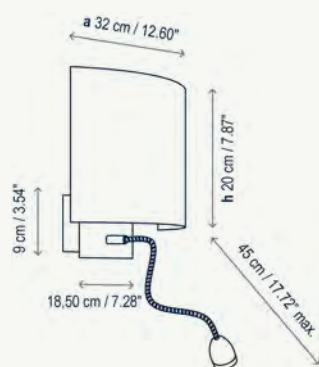

- 1118505FL/P334 Níquel Satinado - Cinta Translúcida Blanca  
*Satin Nickel - White Translucent Ribbon*
- 1118505FL/P333 Níquel Satinado - Cinta Translúcida Crema  
*Satin Nickel - Cream Translucent Ribbon*
- 1118505FL/P332 Níquel Satinado - Cotonet Blanco  
*Satin Nickel - White Cotton*
- 1118505FL/P339 Níquel Satinado - Cotonet  
*Satin Nickel - Cotton*
- 1118505FL/P338 Níquel Satinado - Plisada  
*Satin Nickel - Pleated*
- 1118506FL/P334 Cromo Brillante - Cinta Translúcida Blanca  
*Brilliant Chrome - White Translucent Ribbon*
- 1118506FL/P333 Cromo Brillante - Cinta Translúcida Crema  
*Brilliant Chrome - Cream Translucent Ribbon*
- 1118506FL/P332 Cromo Brillante - Cotonet Blanco  
*Brilliant Chrome - White Cotton*
- 1118506FL/P339 Cromo Brillante - Cotonet  
*Brilliant Chrome - Cotton*
- 1118506FL/P338 Cromo Brillante - Plisada  
*Brilliant Chrome - Pleated*

Flexo de latón para asegurar una mayor flexibilidad y rigidez  
*Flexo made in brass to ensure greater flexibility and rigidity*



## Wall Street T5/01

Aplique / Wall Lamp

230V  
50Hz



2 x 24 W T5

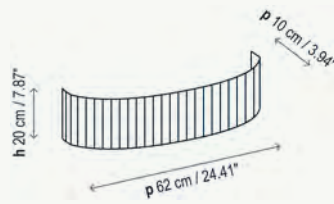

T529001/P606 Estructura Blanca  
Cinta Translúcida Blanca  
*White Structure  
White Translucent Ribbon*

T529001/P607 Estructura Blanca  
Cinta Translúcida Crema  
*White Structure  
Cream Translucent Ribbon*

T529001/P605 Estructura Blanca - Cotonet Blanco  
*White Structure - White Cotton*

## Wall Street T5/02

Aplique / Wall Lamp

230V  
50Hz



2 x 39 W T5

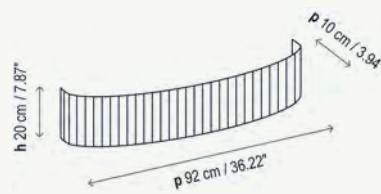

T529002/P612 Estructura Blanca  
Cinta Translúcida Blanca  
*White Structure  
White Translucent Ribbon*

T529002/P613 Estructura Blanca  
Cinta Translúcida Crema  
*White Structure  
Cream Translucent Ribbon*

T529002/P611 Estructura Blanca - Cotonet Blanco  
*White Structure - White Cotton*



### Materiales / Materials

Hierro - Latón  
*Iron - Brass*

### Acabados / Finishing



Níquel Satinado  
*Satin Nickel*

Cromo Brillante  
*Brilliant Chrome*

Cinta Blanca  
*White Ribbon*

Cinta Crema  
*Cream Ribbon*

Cotonet Blanco  
*White Cotton*

Cotonet  
*Cotton*

Plisada  
*Pleated*

# Cala

by Jordi Llopis | 2013



El contorno estilizado y liso, hace de Cala una luminaria contemporánea. El acabado lacado brillo le imprime un aire fresco y actual. La profundidad del difusor inferior aporta mayor calidad lumínica.

*With stylized and smooth outline, Cala is a contemporary lamp. Its bright lacquered external finish gives it a fresh and up-to-date look. The depth of the lower diffuser brings greater light quality.*





## Cala PF/56

Plafón / Ceiling Lamp

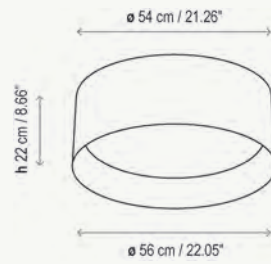
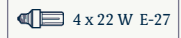

5132601 Blanco Lacado Brillante / *White Brilliant Lacquer*

5132623 Negro Lacado Brillante / *Black Brilliant Lacquer*

5132622 Rojo Lacado Brillante / *Red Brilliant Lacquer*



7132601 Dimable TRIAC - Blanco Lacado Brillante  
*Dimmable TRIAC - White Brilliant Lacquer*

7132623 Dimable TRIAC - Negro Lacado Brillante  
*Dimmable TRIAC - Black Brilliant Lacquer*

7132622 Dimable TRIAC - Rojo Lacado Brillante  
*Dimmable TRIAC - Red Brilliant Lacquer*

## Difusor / Diffuser

Superior: Policarbonato / Inferior: Cristal Óptico  
*Upper: Polycarbonate / Lower: Optical Glass*

## Familia / Family

226 258



## Materiales / Materials

Poliuretano lacado brillante  
*Brilliant lacquer polyurethane*

## Acabados / Finishing

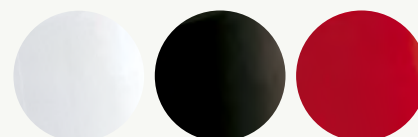

Lacado Blanco  
*White Lacquer*

Lacado Negro  
*Black Lacquer*

Lacado Rojo  
*Red Lacquer*

# Elea

by Joana Bover | 2013



*Hotel Vincci Condal / Barcelona*



Las lámparas Elea debido tanto a su formato, cilíndrico y plano, como a sus materiales, poliuretano acabado lacado brillante; son un producto absolutamente contemporáneo e intemporal.

*Elea lamps with their cylindrical and flat format as well as their glossy lacquered polyurethane materials, are absolutely contemporary and timeless products.*





## Elea PF/55

Plafón / Ceiling Lamp

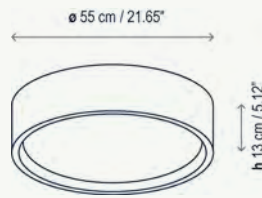
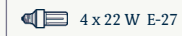

- 510232401 Blanco Lacado Brillante / *White Brilliant Lacquer*
- 510232422 Rojo Lacado Brillante / *Red Brilliant Lacquer*
- 510232423 Negro Lacado Brillante / *Black Brilliant Lacquer*



- 710232401 Dimable TRIAC - Blanco Lacado Brillante  
*Dimmable TRIAC - White Brilliant Lacquer*
- 710232422 Dimable TRIAC - Rojo Lacado Brillante  
*Dimmable TRIAC - Red Brilliant Lacquer*
- 710232423 Dimable TRIAC - Negro Lacado Brillante  
*Dimmable TRIAC - Black Brilliant Lacquer*

## Elea PF/85

Plafón / Ceiling Lamp

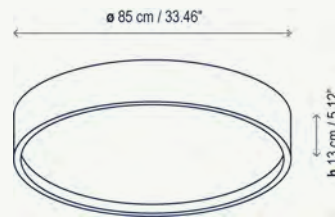

- 510332401 Blanco Lacado Brillante / *White Brilliant Lacquer*
- 510332422 Rojo Lacado Brillante / *Red Brilliant Lacquer*
- 510332423 Negro Lacado Brillante / *Black Brilliant Lacquer*
- \*D510332401 Regulable Sistema DALI-Blanco Lacado Brillante  
*DALI Dimming System-White Brilliant Lacquer*
- \*D510332422 Regulable Sistema DALI-Rojo Lacado Brillante  
*DALI Dimming System-Red Brilliant Lacquer*
- \*D510332423 Regulable Sistema DALI-Negro Lacado Brillante  
*DALI Dimming System-Black Brilliant Lacquer*

## Difusor / Diffuser

Superior: Policarbonato / Inferior: Cristal Óptico  
*Upper: Polycarbonate / Lower: Optical Glass*

## Materiales / Materials

Poliuretano lacado brillante  
*Brilliant lacquer polyurethane*

## Familia / Family



## Acabados / Finishing



# Garota PF

by Alex Fernández Camps / Gonzalo Milà | 2015



## Garota PF/01

Plafón / Ceiling Lamp



1 x 46 W Classic P Eco E-27

1 x 6 W LED E-27 P48

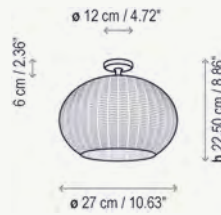

3350110001/P803 Blanco Roto - Pantalla Blanco Marfil  
*Natural White - Ivory White Shade*

3350110001/P804 Blanco Roto - Pantalla Marrón  
*Natural White - Brown Shade*

3350110003/P804 Marrón Grafito - Pantalla Marrón  
*Brown White - Brown Shade*

3350110003/P803 Marrón Grafito - Pantalla Blanco Marfil  
*Brown White - Ivory White Shade*

No incluye globo elipse / *Globe not included*

Garota, inspirada en el caparazón de un erizo de mar, nos ofrece una luz cálida y tamizada; envuelta en formas orgánicas, redondeadas y sutiles; pensada para acompañarnos en zonas de interior y exterior indistintamente.

*Garota, inspired by a sea urchin's shell, offers us a warm and dispersed light; wrapped in organic, rounded and subtle forms; designed to indistinctly accompany us in interior and exterior areas.*

### Familia Interior / Indoor Family

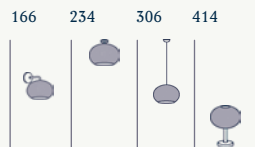

### Familia Exterior / Outdoor Family



### Materiales / Materials

Aluminio - Acero inoxidable - Polietileno - Fibra sintética  
*Aluminum - Stainless steel - Polyethylene - Synthetic fiber*

Todas las fibras sintéticas utilizadas por Bover son reciclables y no tóxicas para la sostenibilidad del medio ambiente

*All synthetic fibers used by Bover are recyclable and non-toxic for environmental sustainability.*

### Acabados / Finishing



# Oliver

by Sergi Devesa / Òscar Devesa | 2013

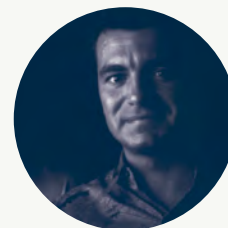
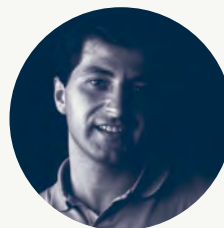

## Oliver

Plafón / Ceiling Lamp

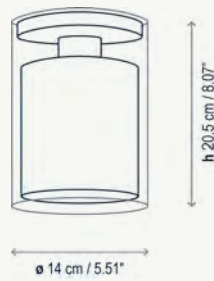

- 5131306/P734C Cromo - Cinta Translúcida Blanca  
Chrome - White Translucent Ribbon
- 5131306/P735C Cromo - Cinta Translúcida Crema  
Chrome - Cream Translucent Ribbon
- 5131306/P736C Cromo - Cinta Translúcida Rojo  
Chrome - Red Translucent Ribbon
- 5131306/P737C Cromo - Cotonet Blanco  
Chrome - White Cotton
- 5131306/P738C Cromo - Cotonet Negro  
Chrome - Black Cotton

Pantalla 12 x 13 cm / Lampshade 4.72"x 5.12"

Oliver consiste en una de las típicas pantallas de Bover recubierta por un cristal de borosilicato; el resultado es una elegante lámpara que ofrece tanto luz directa como de ambiente. Al estar la pantalla textil protegida del polvo, la hace además ideal para proyectos contract.

*Oliver consists of one of the typical Bover shades covered by borosilicate glass; the result is an elegant lamp that offers both direct and ambient light. As the textile shade is protected from dust, it is also ideal for commercial projects.*

### Familia / Family

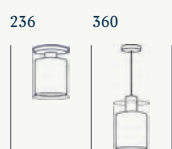

### Materiales / Materials

Vidrio borosilicato - Hierro  
Borosilicate glass - Iron

### Acabados / Finishing

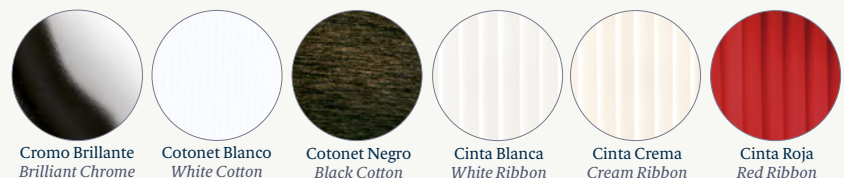

# Plafonet

by Carles Riart / Lluís Porqueras / Joana Bover | 2005



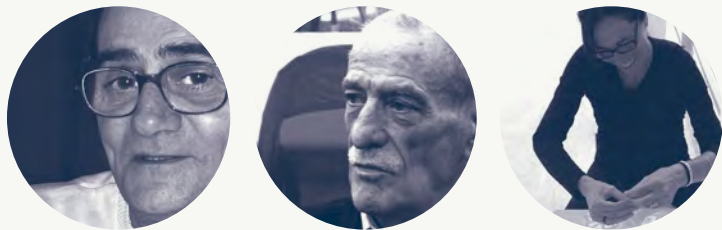

Elegante por su forma, armónico y de discretas proporciones, este plafón ha sido pensado para dar luz a recibidores y pasillos.

*Elegant with its shape, harmonious and of discrete proportions, this ceiling lamp provides light to entrances and corridors.*





## Plafonet 43

Plafón / Ceiling Lamp



2 x 46 W Classic P Eco E-27

2 x 14 W E-27

2 x 6 W LED E-27 P48

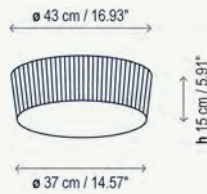

- 0124905B Cromo - Cinta Translúcida Blanca  
*Chrome - White Translucent Ribbon*
- 0124905C Cromo - Cinta Translúcida Crema  
*Chrome - Cream Translucent Ribbon*
- 0124905T Cromo - Cotonet Blanco  
*Chrome - White Cotton*

## Plafonet 60

Plafón / Ceiling Lamp



4 x 46 W Classic P Eco E-27

4 x 14 W E-27

4 x 6 W LED E-27 P48

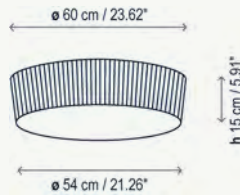

- 0224905B Cromo - Cinta Translúcida Blanca  
*Chrome - White Translucent Ribbon*
- 0224905C Cromo - Cinta Translúcida Crema  
*Chrome - Cream Translucent Ribbon*
- 0224905T Cromo - Cotonet Blanco  
*Chrome - White Cotton*

## Plafonet 95

Plafón / Ceiling Lamp



6 x 22 W E-27

6 x 9 W LED E-27 A60

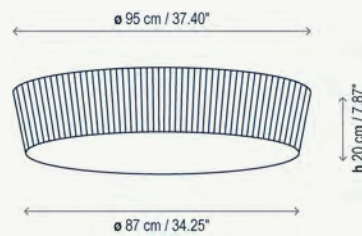

- 0324905B Cromo - Cinta Translúcida Blanca  
*Chrome - White Translucent Ribbon*
- 0324905C Cromo - Cinta Translúcida Crema  
*Chrome - Cream Translucent Ribbon*
- 0324905T Cromo - Cotonet Blanco  
*Chrome - White Cotton*

### Diffusores / Diffusers

Plafonet 43 - 60:  
Cristal Óptico / Optical Glass

Plafonet 95:  
Metacrilato / Methacrylate

### Materiales / Materials

Hierro - Latón  
Iron - Brass

### Acabados / Finishing



Cinta Blanca  
White Ribbon

Cinta Crema  
Cream Ribbon

Cotonet Blanco  
White Cotton

# Siam

by Joana Bover | 2010





Siam nos permiten  
realizar distintas  
composiciones,  
sobreponiendo las  
pantallas parcialmente,  
creando un mural  
adecuado a cada  
espacio y necesidad.

*Siam can be grouped in  
varying compositions,  
superimposing shades  
partially one over the  
other, and creating a  
perfect mural for any  
space and need.*









## Siam 80

Plafón / Ceiling Lamp

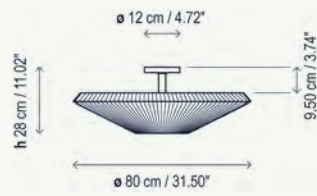
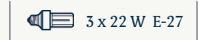

0132005/P686C Estructura Níquel Satinado  
Cinta Translúcida Blanca  
*Satin Nickel - White Translucent Ribbon*

0132005/P687C Estructura Níquel Satinado  
Cinta Translúcida Crema  
*Satin Nickel - Cream Translucent Ribbon*

0132005/P688C Estructura Níquel Satinado  
Cinta Translúcida Roja  
*Satin Nickel - Red Translucent Ribbon*

0132001/P686C Estructura Blanco 9010 Crudo  
Cinta Translúcida Blanca  
*White 9010 - White Translucent Ribbon*

0132001/P687C Estructura Blanco 9010 Crudo  
Cinta Translúcida Crema  
*White 9010 - Cream Translucent Ribbon*

0132001/P688C Estructura Blanco 9010 Crudo  
Cinta Translúcida Roja  
*White 9010 - Red Translucent Ribbon*



# Siam 120

Plafón / Ceiling Lamp

|  |                             |
|--|-----------------------------|
|  | 230V<br>50Hz                |
|  | 6 x 46 W Classic P Eco E-27 |
|  | 6 x 30 W E-27               |
|  | 6 x 9 W LED E-27 A60        |

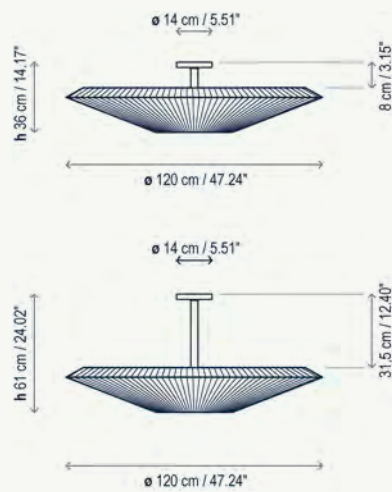

- 0232005P/P698C Estructura Níquel Satinado  
Cinta Translúcida Blanca  
*Satin Nickel - White Translucent Ribbon*
- 0232005P/P699C Estructura Níquel Satinado  
Cinta Translúcida Crema  
*Satin Nickel - Cream Translucent Ribbon*
- 0232005P/P700C Estructura Níquel Satinado  
Cinta Translúcida Roja  
*Satin Nickel - Red Translucent Ribbon*
- 0232001P/P698C Estructura Blanco 9010 Crudo  
Cinta Translúcida Blanca  
*White 9010 - White Translucent Ribbon*
- 0232001P/P699C Estructura Blanco 9010 Crudo  
Cinta Translúcida Crema  
*White 9010 - Cream Translucent Ribbon*
- 0232001P/P700C Estructura Blanco 9010 Crudo  
Cinta Translúcida Roja  
*White 9010 - Red Translucent Ribbon*
- 0232005G/P698C Estructura Grande Níquel Satinado  
Cinta Translúcida Blanca  
*Big Structure - Satin Nickel  
White Translucent Ribbon*
- 0232005G/P699C Estructura Grande Níquel Satinado  
Cinta Translúcida Crema  
*Big Structure - Satin Nickel  
Cream Translucent Ribbon*
- 0232005G/P700C Estructura Grande Níquel Satinado  
Cinta Translúcida Roja  
*Big Structure - Satin Nickel  
Red Translucent Ribbon*
- 0232001G/P698C Estructura Grande Blanco 9010 Crudo  
Cinta Translúcida Blanca  
*Big Structure - White 9010  
White Translucent Ribbon*
- 0232001G/P699C Estructura Grande Blanco 9010 Crudo  
Cinta Translúcida Crema  
*Big Structure - White 9010  
Cream Translucent Ribbon*
- 0232001G/P700C Estructura Grande Blanco 9010 Crudo  
Cinta Translúcida Roja  
*Big Structure - White 9010  
Red Translucent Ribbon*

## Siam 150

Plafón / Ceiling Lamp

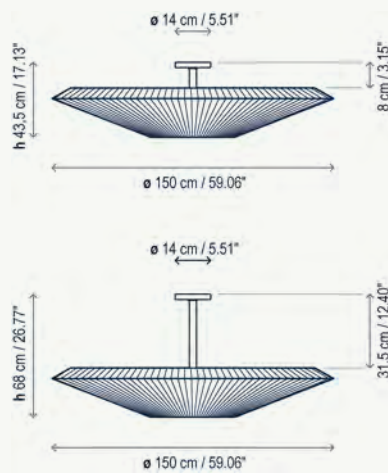

- 0232005P/P773C Estructura Níquel Satinado  
Cinta Translúcida Blanca  
*Satin Nickel - White Translucent Ribbon*
- 0232005P/P774C Estructura Níquel Satinado  
Cinta Translúcida Crema  
*Satin Nickel - Cream Translucent Ribbon*
- 0232005P/P775C Estructura Níquel Satinado  
Cinta Translúcida Roja  
*Satin Nickel - Red Translucent Ribbon*
- 0232001P/P773C Estructura Blanco 9010 Crudo  
Cinta Translúcida Blanca  
*White 9010 - White Translucent Ribbon*
- 0232001P/P774C Estructura Blanco 9010 Crudo  
Cinta Translúcida Crema  
*White 9010 - Cream Translucent Ribbon*
- 0232001P/P775C Estructura Blanco 9010 Crudo  
Cinta Translúcida Roja  
*White 9010 - Red Translucent Ribbon*
- 0232005G/P773C Estructura Grande Níquel Satinado  
Cinta Translúcida Blanca  
*Big Structure - Satin Nickel  
White Translucent Ribbon*
- 0232005G/P774C Estructura Grande Níquel Satinado  
Cinta Translúcida Crema  
*Big Structure - Satin Nickel  
Cream Translucent Ribbon*
- 0232005G/P775C Estructura Grande Níquel Satinado  
Cinta Translúcida Roja  
*Big Structure - Satin Nickel  
Red Translucent Ribbon*
- 0232001G/P773C Estructura Grande Blanco 9010 Crudo  
Cinta Translúcida Blanca  
*Big Structure - White 9010  
White Translucent Ribbon*
- 0232001G/P774C Estructura Grande Blanco 9010 Crudo  
Cinta Translúcida Crema  
*Big Structure - White 9010  
Cream Translucent Ribbon*
- 0232001G/P775C Estructura Grande Blanco 9010 Crudo  
Cinta Translúcida Roja  
*Big Structure - White 9010  
Red Translucent Ribbon*

## Familia / Family



## Siam 200

Plafón / Ceiling Lamp

230V  
50Hz

8 x 46 W Classic P Eco E-27

8 x 30 W E-27

8 x 9 W LED E-27 A60

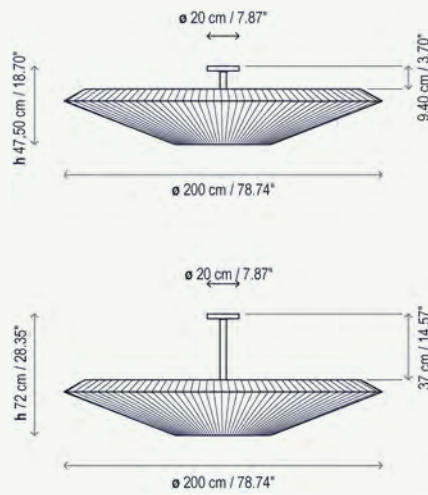

0332005P/P690C Estructura Níquel Satinado  
Cinta Translúcida Blanca  
*Satin Nickel - White Translucent Ribbon*

0332005P/P691C Estructura Níquel Satinado  
Cinta Translúcida Crema  
*Satin Nickel - Cream Translucent Ribbon*

0332005P/P692C Estructura Níquel Satinado  
Cinta Translúcida Roja  
*Satin Nickel - Red Translucent Ribbon*

0332001P/P690C Estructura Blanco 9010 Crudo  
Cinta Translúcida Blanca  
*White 9010 - White Translucent Ribbon*

0332001P/P691C Estructura Blanco 9010 Crudo  
Cinta Translúcida Crema  
*White 9010 - Cream Translucent Ribbon*

0332001P/P692C Estructura Blanco 9010 Crudo  
Cinta Translúcida Roja  
*White 9010 - Red Translucent Ribbon*

0332005G/P690C Estructura Grande Níquel Satinado  
Cinta Translúcida Blanca  
*Big Structure - Satin Nickel  
White Translucent Ribbon*

0332005G/P691C Estructura Grande Níquel Satinado  
Cinta Translúcida Crema  
*Big Structure - Satin Nickel  
Cream Translucent Ribbon*

0332005G/P692C Estructura Grande Níquel Satinado  
Cinta Translúcida Roja  
*Big Structure - Satin Nickel  
Red Translucent Ribbon*

0332001G/P690C Estructura Grande Blanco 9010 Crudo  
Cinta Translúcida Blanca  
*Big Structure - White 9010  
White Translucent Ribbon*

0332001G/P691C Estructura Grande Blanco 9010 Crudo  
Cinta Translúcida Crema  
*Big Structure - White 9010  
Cream Translucent Ribbon*

0332001G/P692C Estructura Grande Blanco 9010 Crudo  
Cinta Translúcida Roja  
*Big Structure - White 9010  
Red Translucent Ribbon*

### Difusor / Diffuser

Inferior: PVC 500  
Lower: PVC 500

### Materiales / Materials

Hierro  
Iron

### Acabados / Finishing



# Urban

by Joana Bover | 2011





La colección Urban ofrece luz de ambiente a través de la pantalla de cinta hecha a mano y del difusor de metacrilato; aportando calidez e intemporalidad tanto a ambientes residenciales como contract.

*The Urban collection offers ambient light through its handmade ribbon shade and the methacrylate diffuser; bringing warmth and timelessness to both residential and commercial environments.*



*Custom product*  
*Restaurant Club Nàutic L'Escala / Girona*



### Urban PF/37

Plafón / Ceiling Lamp



2 x 46 W Classic P Eco E-27

2 x 22 W E-27

2 x 6 W LED E-27 P48

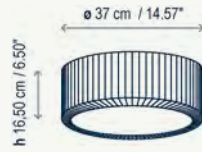

0132506B Cromo - Cinta Translúcida Blanca  
*Chrome - White Translucent Ribbon*

0132506C Cromo - Cinta Translúcida Crema  
*Chrome - Cream Translucent Ribbon*

0132506R Cromo - Cinta Translúcida Roja  
*Chrome - Red Translucent Ribbon*

### Urban PF/60

Plafón / Ceiling Lamp



4 x 46 W Classic P Eco E-27

4 x 22 W E-27

4 x 6 W LED E-27 P48

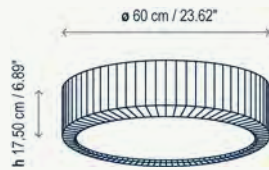

0232506B Cromo - Cinta Translúcida Blanca  
*Chrome - White Translucent Ribbon*

0232506C Cromo - Cinta Translúcida Crema  
*Chrome - Cream Translucent Ribbon*

0232506R Cromo - Cinta Translúcida Roja  
*Chrome - Red Translucent Ribbon*



34 W LED  
2686 lm / CRI: 80 / 2700° K

710232506B Dimable TRIAC - Cromo  
Cinta Translúcida Blanca  
*Dimmable TRIAC - Chrome  
White Translucent Ribbon*

710232506C Dimable TRIAC - Cromo  
Cinta Translúcida Crema  
*Dimmable TRIAC - Chrome  
Cream Translucent Ribbon*

710232506R Dimable TRIAC - Cromo  
Cinta Translúcida Roja  
*Dimmable TRIAC - Chrome  
Red Translucent Ribbon*

### Familia / Family





## Urban PF/90

Plafón / Ceiling Lamp

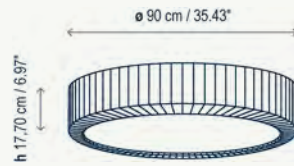

- 0432506B Cromo - Cinta Translúcida Blanca  
*Chrome - White Translucent Ribbon*
- 0432506C Cromo - Cinta Translúcida Crema  
*Chrome - Cream Translucent Ribbon*
- 0432506R Cromo - Cinta Translúcida Roja  
*Chrome - Red Translucent Ribbon*
- \*D0432506B Regulable Sistema DALI - Cromo  
Cinta Translúcida Blanca  
*DALI Dimming System - Chrome  
White Translucent Ribbon*
- \*D0432506C Regulable Sistema DALI - Cromo  
Cinta Translúcida Crema  
*DALI Dimming System - Chrome  
Cream Translucent Ribbon*
- \*D0432506R Regulable Sistema DALI - Cromo  
Cinta Translúcida Roja  
*DALI Dimming System - Chrome  
Red Translucent Ribbon*

## Urban PF/120

Plafón / Ceiling Lamp



- 0332506B Cromo - Cinta Translúcida Blanca  
*Chrome - White Translucent Ribbon*
- 0332506C Cromo - Cinta Translúcida Crema  
*Chrome - Cream Translucent Ribbon*
- 0332506R Cromo - Cinta Translúcida Roja  
*Chrome - Red Translucent Ribbon*
- \*D0332506B Regulable Sistema DALI - Cromo  
Cinta Translúcida Blanca  
*DALI Dimming System - Chrome  
White Translucent Ribbon*
- \*D0332506C Regulable Sistema DALI - Cromo  
Cinta Translúcida Crema  
*DALI Dimming System - Chrome  
Cream Translucent Ribbon*
- \*D0332506R Regulable Sistema DALI - Cromo  
Cinta Translúcida Roja  
*DALI Dimming System - Chrome  
Red Translucent Ribbon*

### Diffusor / Diffuser

Urban PF/37 - Urban PF/60:  
Cristal Óptico / Optical Glass

Urban PF/90 - Urban PF/120:  
Superior / Upper:  
Policarbonato / Polycarbonate  
Inferior / Lower:  
Metacrilato / Methacrylate

### Materiales / Materials

Hierro  
Iron

### Acabados / Finishing



# Cala

by Jordi Llopis | 2013



El contorno estilizado y liso, hace de Cala una luminaria contemporánea. El acabado lacado brillo le imprime un aire fresco y actual. La profundidad del difusor inferior aporta mayor calidad lumínica.

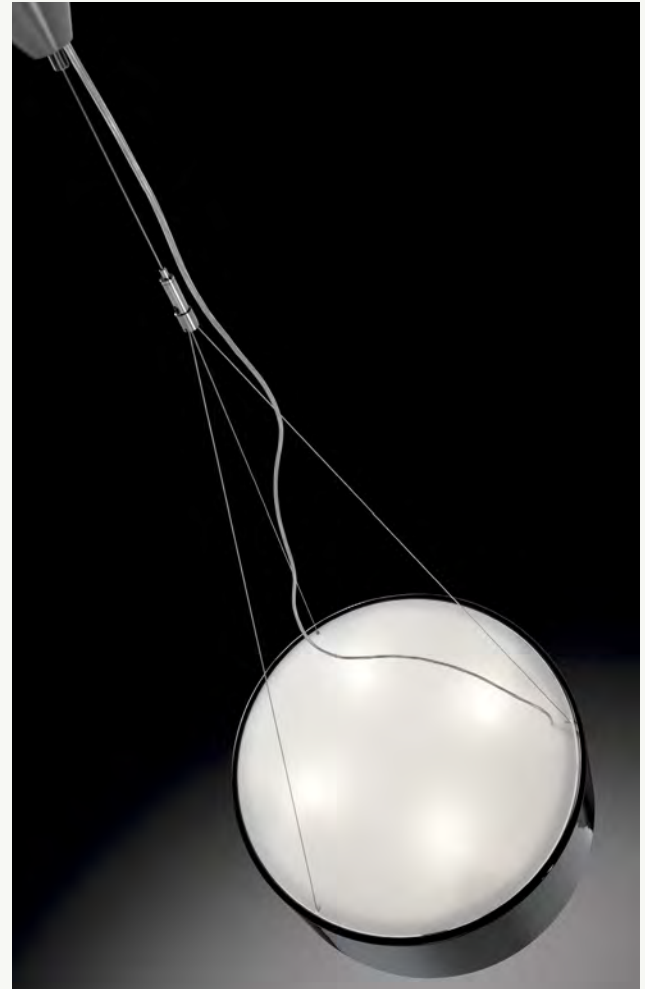
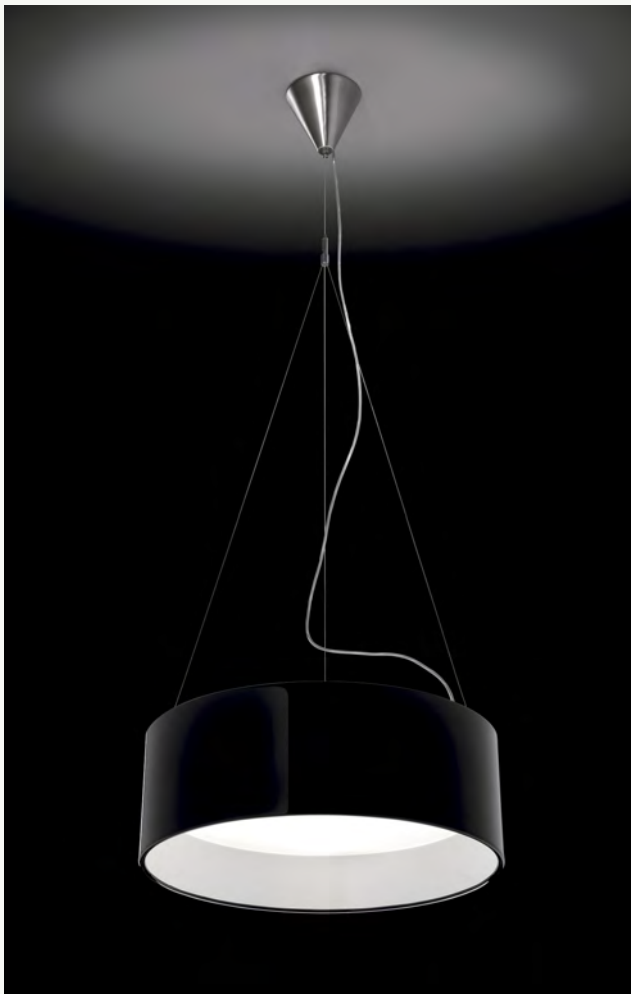

*With stylized and smooth outline, Cala is a contemporary lamp. Its bright lacquered external finish gives it a fresh and up-to-date look. The depth of the lower diffuser brings greater light quality.*



## Cala S/56

Suspensión / Pendant Lamp



4 x 46 W Classic P Eco E-27

4 x 22 W E-27

4 x 9 W LED E-27 A60

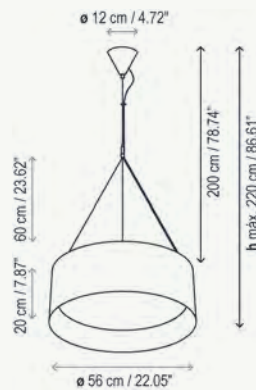

34 W LED  
2686 lm / CRI: 80 / 2700° K

4132601 Blanco Lacado Brillante / *White Brilliant Lacquer*

4132623 Negro Lacado Brillante / *Black Brilliant Lacquer*

4132622 Rojo Lacado Brillante / *Red Brilliant Lacquer*

6132601 Dimable TRIAC - Blanco Lacado Brillante  
*Dimmable TRIAC - White Brilliant Lacquer*

6132623 Dimable TRIAC - Negro Lacado Brillante  
*Dimmable TRIAC - Black Brilliant Lacquer*

6132622 Dimable TRIAC - Rojo Lacado Brillante  
*Dimmable TRIAC - Red Brilliant Lacquer*

### Difusores / Diffusers

Superior: Policarbonato / Inferior: Cristal Óptico  
*Upper: Polycarbonate / Lower: Optical Glass*

### Familia / Family

226 258



### Materiales / Materials

Poliuretano lacado brillante  
*Brilliant lacquer polyurethane*

### Acabados / Finishing

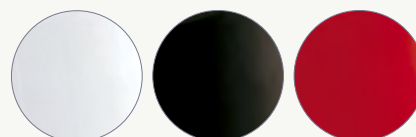

Lacado Blanco  
*White Lacquer*

Lacado Negro  
*Black Lacquer*

Lacado Rojo  
*Red Lacquer*

# Danona

by Joana Bover | 2002





Danona es un claro ejemplo de un producto contemporáneo e intemporal que se adapta a cualquier ambiente o aplicación. Tanto la piel como las pantallas le aportan calidez.

*Danona is a good example of contemporaneous and timeless product adaptable to any environment. Both leather along with the shades contribute to its warmth.*





## Danona 1L

Suspensión / Pendant Lamp



1 x 77 W Classic A Eco E-27

1 x 18 W E-27

1 x 9 W LED E-27 A60

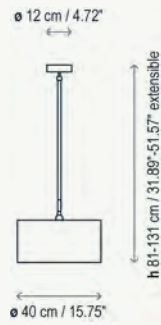

- 4123105/P416 Níquel Satinado - Cotonet  
*Satin Nickel - Cotton*
- 4123105/P421 Níquel Satinado - Cinta Translúcida Crema  
*Satin Nickel - Cream Translucent Ribbon*
- 4123105/P420 Níquel Satinado - Cinta Translúcida Blanca  
*Satin Nickel - White Translucent Ribbon*
- 4123160/P416 Níquel Piel Oscura - Cotonet  
*Nickel Dark Brown Leather - Cotton*
- 4123160/P421 Níquel Piel Oscura  
Cinta Translúcida Crema  
*Nickel Dark Brown Leather  
Cream Translucent Ribbon*
- 4123160/P420 Níquel Piel Oscura  
Cinta Translúcida Blanca  
*Nickel Dark Brown Leather  
White Translucent Ribbon*

Pantalla 40 x 22 x 40 cm / Lampshade 15.75" x 8.66" x 15.75"

## Danona 3L

Suspensión / Pendant Lamp



3 x 77 W Classic A Eco E-27

3 x 18 W E-27

3 x 9 W LED E-27 A60

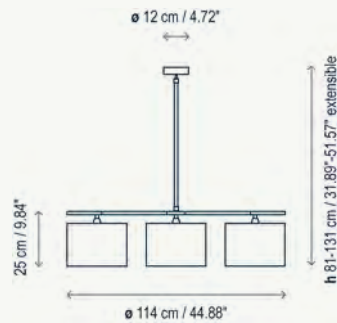

- 4323105/P150 Níquel Satinado - Cotonet  
*Satin Nickel - Cotton*
- 4323105/P005C Níquel Satinado - Cinta Translúcida Crema  
*Satin Nickel - Cream Translucent Ribbon*
- 4323105/P006C Níquel Satinado - Cinta Translúcida Blanca  
*Satin Nickel - White Translucent Ribbon*
- 4323160/P150 Níquel Piel Oscura - Cotonet  
*Nickel Dark Brown Leather - Cotton*
- 4323160/P005C Níquel Piel Oscura  
Cinta Translúcida Crema  
*Nickel Dark Brown Leather  
Cream Translucent Ribbon*
- 4323160/P006C Níquel Piel Oscura  
Cinta Translúcida Blanca  
*Nickel Dark Brown Leather  
White Translucent Ribbon*

Pantalla 27 x 18 x 27 cm / Lampshade 10.63" x 7.09" x 10.63"

### Difusor / Diffuser

Metacrilato / Methacrylate

### Materiales / Materials

Hierro  
Iron

### Familia / Family

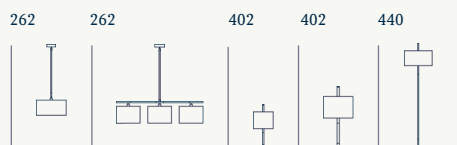

### Acabados / Finishing



# Dome

by Benedetta Tagliabue / EMBT | 2015



**BEST of year** INTERIOR DESIGN  
HONOREE 2015



Dome es una escultura lumínica que crea un juego de luces y sombras a través de sus más de 170 piezas de madera entrelazadas.

*Dome is a sculpture that creates a play of light and shadow through its more than 170 intertwined wood pieces.*

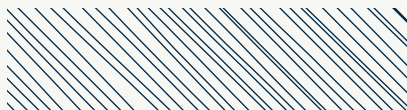





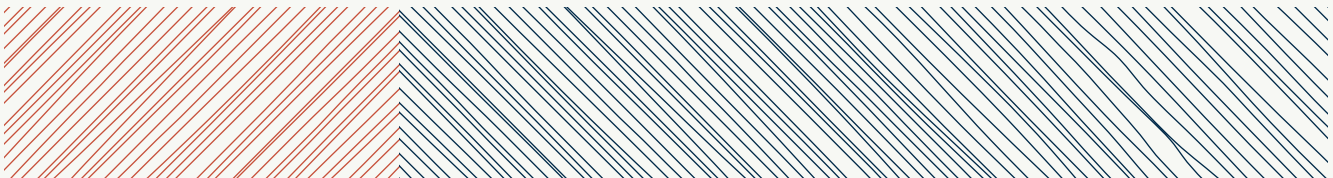

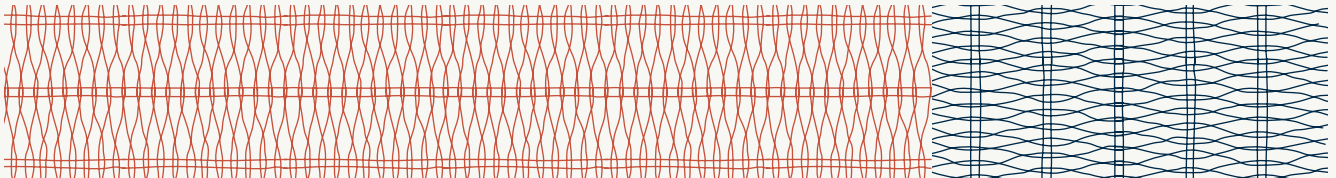







## Dome 60/01

Suspensión / Pendant Lamp



12,3 W LED  
1332 lm / CRI: 90 / 2700° K

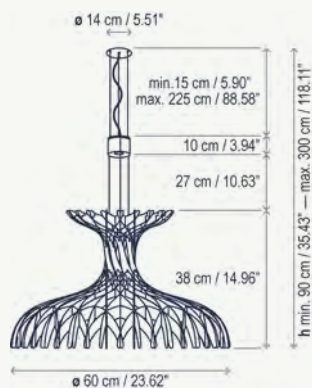

2580621400/P829 Reflector Lumínico Directo - Blanco Mate  
Pantalla Madera Natural  
*Direct Electric Set - Matte White  
Natural Wood Shade*

2580621412/P829 Reflector Lumínico Directo - Negro Mate  
Pantalla Madera Natural  
*Direct Electric Set - Matte Black  
Natural Wood Shade*

Sistema de regulación TRIAC / TRIAC dimming system

## Dome 60/02

Suspensión / Pendant Lamp



24,6 W LED / 2 x 12,3 W = 24,6 W  
2664 lm / CRI: 90 / 2700° K

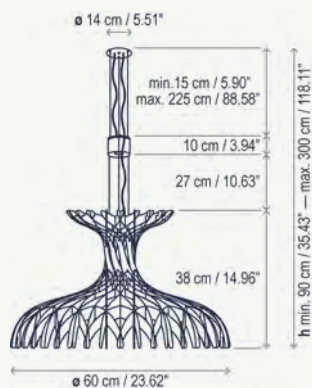

2580721400/P829 Reflector Lumínico Directo e Indirecto  
Blanco Mate  
Pantalla Madera Natural  
*Direct/Indirect Electric Set - Matte White  
Natural Wood Shade*

2580721412/P829 Reflector Lumínico Directo e Indirecto  
Negro Mate  
Pantalla Madera Natural  
*Direct/Indirect Electric Set - Matte Black  
Natural Wood Shade*

Sistema de regulación TRIAC / TRIAC dimming system

## Dome 90

Suspensión / Pendant Lamp

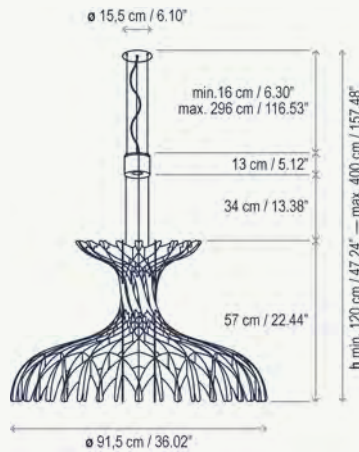

2580921400/P811 Reflector Lumínico Directo - Blanco Mate  
Pantalla Madera Natural  
*Direct Electric Set - Matte White*  
*Natural Wood Shade*

2580921412/P811 Reflector Lumínico Directo - Negro Mate  
Pantalla Madera Natural  
*Direct Electric Set - Matte Black*  
*Natural Wood Shade*

Sistema de regulación TRIAC / *TRIAC dimming system*

## Dome 180

Suspensión / Pendant Lamp

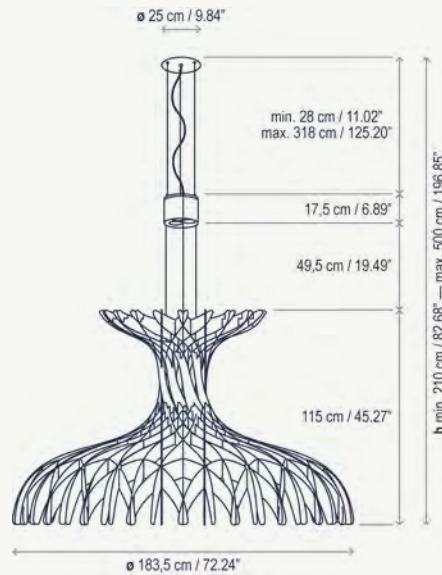

2581821400/P812 Reflector Lumínico Directo - Blanco Mate  
Pantalla Madera Natural  
*Direct Electric Set - Matte White*  
*Natural Wood Shade*

2581821412/P812 Reflector Lumínico Directo - Negro Mate  
Pantalla Madera Natural  
*Direct Electric Set - Matte Black*  
*Natural Wood Shade*

Sistema de regulación TRIAC / *TRIAC dimming system*

### Materiales / Materials

Madera acabado haya - Hierro o Aluminio  
*Wood finished beech - Iron or Aluminum*

### Acabados / Finishing

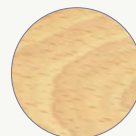

Madera Natural  
*Natural Wood*



Blanco Mate  
*Matte White*



Negro Mate  
*Matte Black*

# Drip/Drop

by Christophe Mathieu | 2017



Con Drip & Drop el objetivo estuvo claro desde el principio: hacer una lámpara de suspensión en cascada. El resultado, más de diez formatos que satisface tanto las necesidades residenciales como las del sector contract.

*With Drip & Drop, the goal was clear from the beginning: make a cascading pendant lamp. The result is a design with more than ten references that satisfies both residential and commercial sector needs.*

























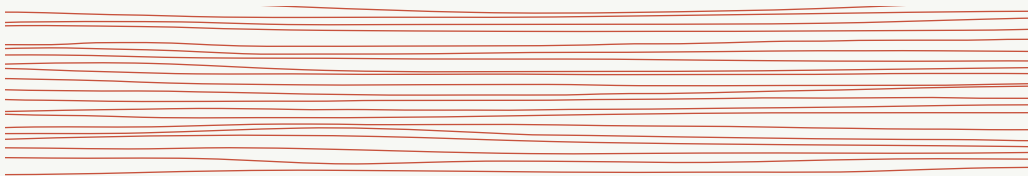





## Drip S/01L

Suspensión / Pendant Lamp



230V  
50Hz



TRIAC



3 W LED  
345 lm / CRI: 90 / 2700° K

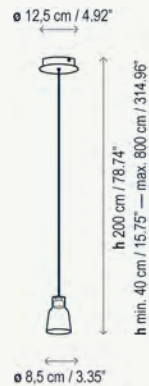

- 2590120838 Ébano Negro - Vidrio Transparente  
*Black Ebony - Transparent Glass*
- 2590120839 Ébano Negro - Vidrio Matizado  
*Black Ebony - Frosted Glass*
- 2590120881 Ébano Negro - Vidrio Verde  
*Black Ebony - Green Glass*
- 2590120886 Ébano Negro - Vidrio Azul  
*Black Ebony - Blue Glass*

Cable coaxial negro / *Black coaxial cable*

No se pueden cortar o manipular los cables  
*Each light has a different cable length. The cables cannot be cut or handled.*

## Drip S/03L

Suspensión / Pendant Lamp



230V  
50Hz



TRIAC



8,4 W LED / 3 x 2,8 W = 8,4 W  
2070 lm / CRI: 90 / 2700° K

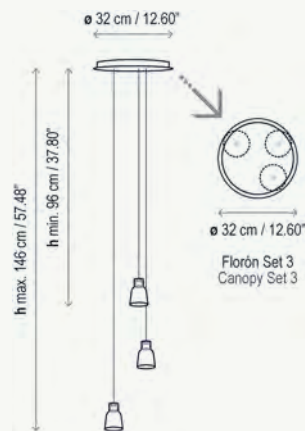

- 2590321538 Ébano Negro - Vidrio Transparente  
Dimable TRIAC  
*Black Ebony - Transparente Glass  
Dimmable TRIAC*
- 2590321539 Ébano Negro - Vidrio Matizado  
Dimable TRIAC  
*Black Ebony - Frosted Glass  
Dimmable TRIAC*
- 2590321581 Ébano Negro - Vidrio Verde  
Dimable TRIAC  
*Black Ebony - Green Glass  
Dimmable TRIAC*
- 2590321586 Ébano Negro - Vidrio Azul  
Dimable TRIAC  
*Black Ebony - Blue Glass  
Dimmable TRIAC*

Cable coaxial negro, altura máxima 13 mts.  
*Black coaxial cable, max. Height 13 mts.*

Existen 13 largos de cable estándar para realizar diferentes composiciones. Consultar hoja técnica.  
*There are 13 standard cable lengths to make different compositions. Refer to Technical Data Sheet.*

No se pueden cortar o manipular los cables  
*Each light has a different cable length. The cables cannot be cut or handled.*

## Drop S/01L

Suspensión / Pendant Lamp

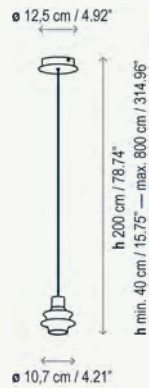

- 2590120856 Ébano Negro - Vidrio Transparente  
*Black Ebony - Transparent Glass*
- 2590120857 Ébano Negro - Vidrio Matizado  
*Black Ebony - Frosted Glass*
- 2590120858 Ébano Negro - Vidrio Verde  
*Black Ebony - Green Glass*
- 2590120859 Ébano Negro - Vidrio Azul  
*Black Ebony - Blue Glass*

Cable coaxial negro / *Black coaxial cable*

No se pueden cortar o manipular los cables  
*Each light has a different cable length. The cables cannot be cut or handled.*

## Drop S/03L

Suspensión / Pendant Lamp

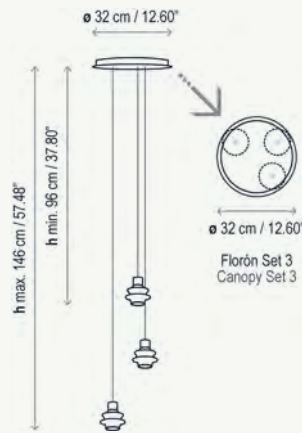

- 2590321556 Ébano Negro - Vidrio Transparente  
Dimable TRIAC  
*Black Ebony - Transparente Glass  
Dimmable TRIAC*
- 2590321557 Ébano Negro - Vidrio Matizado  
Dimable TRIAC  
*Black Ebony - Frosted Glass  
Dimmable TRIAC*
- 2590321558 Ébano Negro - Vidrio Verde  
Dimable TRIAC  
*Black Ebony - Green Glass  
Dimmable TRIAC*
- 2590321559 Ébano Negro - Vidrio Azul  
Dimable TRIAC  
*Black Ebony - Blue Glass  
Dimmable TRIAC*

Cable coaxial negro, altura máxima 13 mts.  
*Black coaxial cable, max. Height 13 mts.*

Existen 13 largos de cable estándar para realizar diferentes composiciones. Consultar hoja técnica.  
*There are 13 standard cable lengths to make different compositions. Refer to Technical Data Sheet.*

No se pueden cortar o manipular los cables  
*Each light has a different cable length. The cables cannot be cut or handled.*

## Drip S/06L

Suspensión / Pendant Lamp

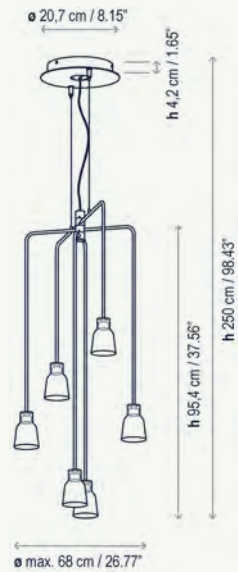

- 2590621538 Ébano Negro - Vidrio Transparente  
Dimable TRIAC  
*Black Ebony - Transparente Glass  
Dimmable TRIAC*
- 2590621539 Ébano Negro - Vidrio Matizado  
Dimable TRIAC  
*Black Ebony - Frosted Glass  
Dimmable TRIAC*
- 2590621581 Ébano Negro - Vidrio Verde  
Dimable TRIAC  
*Black Ebony - Green Glass  
Dimmable TRIAC*
- 2590621586 Ébano Negro - Vidrio Azul  
Dimable TRIAC  
*Black Ebony - Blue Glass  
Dimmable TRIAC*

Lámpara con estructura tubular móvil / *Swivel tubular structure*

## Drip S/07L

Suspensión / Pendant Lamp

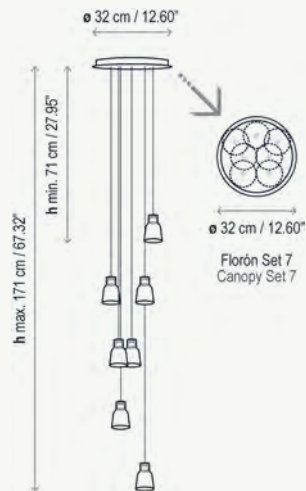

- 2590721538 Ébano Negro - Vidrio Transparente  
Dimable TRIAC  
*Black Ebony - Transparente Glass  
Dimmable TRIAC*
- 2590721539 Ébano Negro - Vidrio Matizado  
Dimable TRIAC  
*Black Ebony - Frosted Glass  
Dimmable TRIAC*
- 2590721581 Ébano Negro - Vidrio Verde  
Dimable TRIAC  
*Black Ebony - Green Glass  
Dimmable TRIAC*
- 2590721586 Ébano Negro - Vidrio Azul  
Dimable TRIAC  
*Black Ebony - Blue Glass  
Dimmable TRIAC*

Cable coaxial negro, altura máxima 13 mts.  
*Black coaxial cable, max. Height 13 mts.*

Existen 13 largos de cable estándar para realizar diferentes composiciones. Consultar hoja técnica.  
*There are 13 standard cable lengths to make different compositions. Refer to Technical Data Sheet.*

No se pueden cortar o manipular los cables  
*Each light has a different cable length. The cables cannot be cut or handled.*

## Drop S/06L

Suspensión / Pendant Lamp

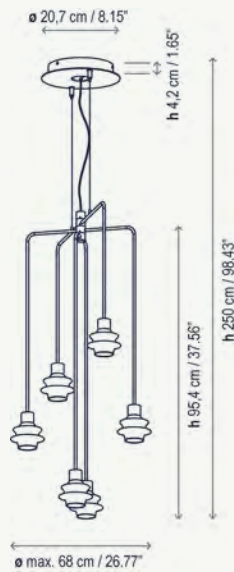

- 2590621556 Ébano Negro - Vidrio Transparente  
Dimable TRIAC  
*Black Ebony - Transparente Glass  
Dimmable TRIAC*
- 2590621557 Ébano Negro - Vidrio Matizado  
Dimable TRIAC  
*Black Ebony - Frosted Glass  
Dimmable TRIAC*
- 2590621558 Ébano Negro - Vidrio Verde  
Dimable TRIAC  
*Black Ebony - Green Glass  
Dimmable TRIAC*
- 2590621559 Ébano Negro - Vidrio Azul  
Dimable TRIAC  
*Black Ebony - Blue Glass  
Dimmable TRIAC*

Lámpara con estructura tubular móvil / *Swivel tubular structure*

## Drop S/07L

Suspensión / Pendant Lamp

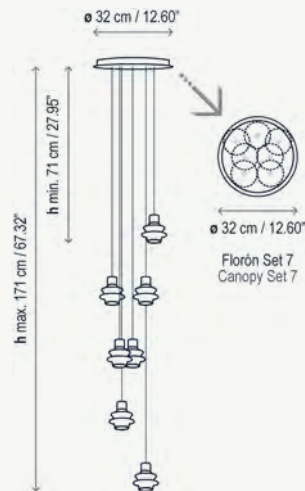

- 2590721556 Ébano Negro - Vidrio Transparente  
Dimable TRIAC  
*Black Ebony - Transparente Glass  
Dimmable TRIAC*
- 2590721557 Ébano Negro - Vidrio Matizado  
Dimable TRIAC  
*Black Ebony - Frosted Glass  
Dimmable TRIAC*
- 2590721558 Ébano Negro - Vidrio Verde  
Dimable TRIAC  
*Black Ebony - Green Glass  
Dimmable TRIAC*
- 2590721559 Ébano Negro - Vidrio Azul  
Dimable TRIAC  
*Black Ebony - Blue Glass  
Dimmable TRIAC*

Cable coaxial negro, altura máxima 13 mts.  
*Black coaxial cable, max. Height 13 mts.*

Existen 13 largos de cable estándar para realizar diferentes composiciones. Consultar hoja técnica.  
*There are 13 standard cable lengths to make different compositions. Refer to Technical Data Sheet.*

No se pueden cortar o manipular los cables  
*Each light has a different cable length. The cables cannot be cut or handled.*

## Drip S/12L

Suspensión / Pendant Lamp

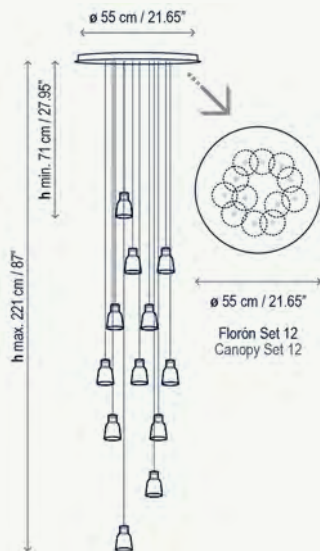

- 2591221538 Ébano Negro - Vidrio Transparente  
Dimable TRIAC  
*Black Ebony - Transparente Glass  
Dimmable TRIAC*
- 2591221539 Ébano Negro - Vidrio Matizado  
Dimable TRIAC  
*Black Ebony - Frosted Glass  
Dimmable TRIAC*
- 2591221581 Ébano Negro - Vidrio Verde  
Dimable TRIAC  
*Black Ebony - Green Glass  
Dimmable TRIAC*
- 2591221586 Ébano Negro - Vidrio Azul  
Dimable TRIAC  
*Black Ebony - Blue Glass  
Dimmable TRIAC*

Cable coaxial negro, altura máxima 13 mts.  
*Black coaxial cable, max. Height 13 mts.*

Existen 13 largos de cable estándar para realizar diferentes composiciones. Consultar hoja técnica.  
*There are 13 standard cable lengths to make different compositions. Refer to Technical Data Sheet.*

No se pueden cortar o manipular los cables / Each light has a different cable length. The cables cannot be cut or handled.

## Drip S/24L

Suspensión / Pendant Lamp

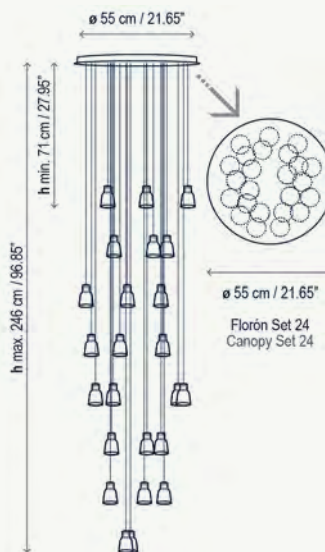

- 2592421038 Ébano Negro - Vidrio Transparente  
Dimable TRIAC  
*Black Ebony - Transparente Glass  
Dimmable TRIAC*
- 2592421039 Ébano Negro - Vidrio Matizado  
Dimable TRIAC  
*Black Ebony - Frosted Glass  
Dimmable TRIAC*
- 2592421081 Ébano Negro - Vidrio Verde  
Dimable TRIAC  
*Black Ebony - Green Glass  
Dimmable TRIAC*
- 2592421086 Ébano Negro - Vidrio Azul  
Dimable TRIAC  
*Black Ebony - Blue Glass  
Dimmable TRIAC*

Cable coaxial negro, altura máxima 13 mts.  
*Black coaxial cable, max. Height 13 mts.*

Existen 13 largos de cable estándar para realizar diferentes composiciones. Consultar hoja técnica.  
*There are 13 standard cable lengths to make different compositions. Refer to Technical Data Sheet.*

No se pueden cortar o manipular los cables / Each light has a different cable length. The cables cannot be cut or handled.

## Drop S/12L

Suspensión / Pendant Lamp

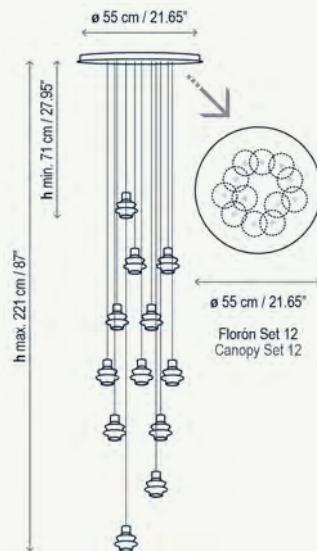

- 2591221556 Ébano Negro - Vidrio Transparente  
Dimable TRIAC  
*Black Ebony - Transparente Glass  
Dimmable TRIAC*
- 2591221557 Ébano Negro - Vidrio Matizado  
Dimable TRIAC  
*Black Ebony - Frosted Glass  
Dimmable TRIAC*
- 2591221558 Ébano Negro - Vidrio Verde  
Dimable TRIAC  
*Black Ebony - Green Glass  
Dimmable TRIAC*
- 2591221559 Ébano Negro - Vidrio Azul  
Dimable TRIAC  
*Black Ebony - Blue Glass  
Dimmable TRIAC*

Cable coaxial negro, altura máxima 13 mts.  
*Black coaxial cable, max. Height 13 mts.*

Existen 13 largos de cable estándar para realizar diferentes composiciones. Consultar hoja técnica.  
*There are 13 standard cable lengths to make different compositions. Refer to Technical Data Sheet.*

No se pueden cortar o manipular los cables / Each light has a different cable length. The cables cannot be cut or handled.

## Drop S/24L

Suspensión / Pendant Lamp

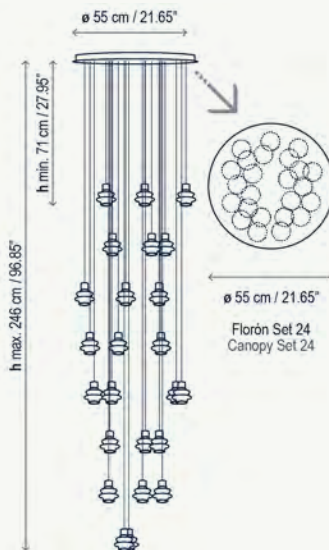

- 2592421056 Ébano Negro - Vidrio Transparente  
Dimable TRIAC  
*Black Ebony - Transparente Glass  
Dimmable TRIAC*
- 2592421057 Ébano Negro - Vidrio Matizado  
Dimable TRIAC  
*Black Ebony - Frosted Glass  
Dimmable TRIAC*
- 2592421058 Ébano Negro - Vidrio Verde  
Dimable TRIAC  
*Black Ebony - Green Glass  
Dimmable TRIAC*
- 2592421059 Ébano Negro - Vidrio Azul  
Dimable TRIAC  
*Black Ebony - Blue Glass  
Dimmable TRIAC*

Cable coaxial negro, altura máxima 13 mts.  
*Black coaxial cable, max. Height 13 mts.*

Existen 13 largos de cable estándar para realizar diferentes composiciones. Consultar hoja técnica.  
*There are 13 standard cable lengths to make different compositions. Refer to Technical Data Sheet.*

No se pueden cortar o manipular los cables / Each light has a different cable length. The cables cannot be cut or handled.

## Drip S/36L

Suspensión / Pendant Lamp

100,8 W LED / 36 x 2,8 W = 100,8 W
   
 13392 lm / CRI: 90 / 2700° K

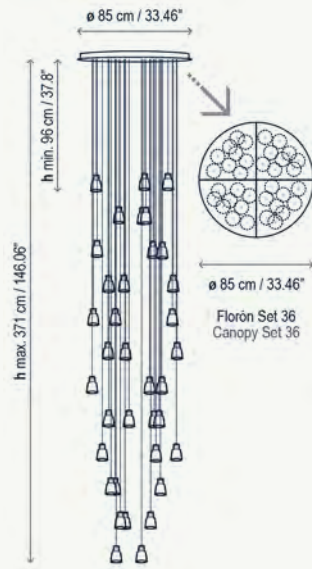

- 2593621038 Ébano Negro - Vidrio Transparente  
Dimable TRIAC  
Black Ebony - Transparente Glass  
Dimmable TRIAC
- 2593621039 Ébano Negro - Vidrio Matizado  
Dimable TRIAC  
Black Ebony - Frosted Glass  
Dimmable TRIAC
- 2593621081 Ébano Negro - Vidrio Verde  
Dimable TRIAC  
Black Ebony - Green Glass  
Dimmable TRIAC
- 2593621086 Ébano Negro - Vidrio Azul  
Dimable TRIAC  
Black Ebony - Blue Glass  
Dimmable TRIAC

Cable coaxial negro, altura máxima 13 mts.  
Black coaxial cable, max. Height 13 mts.

Existen 13 largos de cable estándar para realizar diferentes composiciones. Consultar hoja técnica.  
There are 13 standard cable lengths to make different compositions. Refer to Technical Data Sheet.

No se pueden cortar o manipular los cables / Each light has a different cable length. The cables cannot be cut or handled.

## Drip S/48L

Suspensión / Pendant Lamp

134,4 W LED / 48 x 2,8 W = 134,4 W
   
 17856 lm / CRI: 90 / 2700° K

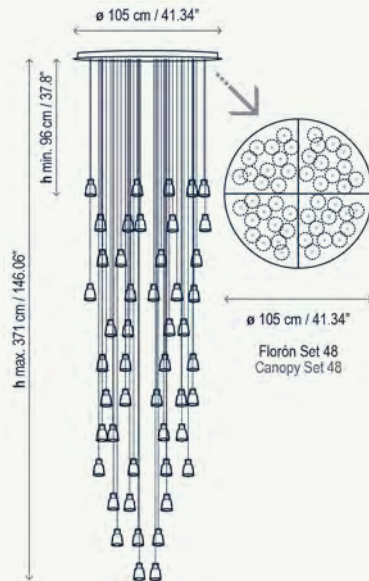

- 2594821038 Ébano Negro - Vidrio Transparente  
Dimable TRIAC  
Black Ebony - Transparente Glass  
Dimmable TRIAC
- 2594821039 Ébano Negro - Vidrio Matizado  
Dimable TRIAC  
Black Ebony - Frosted Glass  
Dimmable TRIAC
- 2594821081 Ébano Negro - Vidrio Verde  
Dimable TRIAC  
Black Ebony - Green Glass  
Dimmable TRIAC
- 2594821086 Ébano Negro - Vidrio Azul  
Dimable TRIAC  
Black Ebony - Blue Glass  
Dimmable TRIAC

Cable coaxial negro, altura máxima 13 mts.  
Black coaxial cable, max. Height 13 mts.

Existen 13 largos de cable estándar para realizar diferentes composiciones. Consultar hoja técnica.  
There are 13 standard cable lengths to make different compositions. Refer to Technical Data Sheet.

No se pueden cortar o manipular los cables / Each light has a different cable length. The cables cannot be cut or handled.

### Familia / Family



### Materiales / Materials

Hierro - Vidrio borosilicato  
Iron - Borosilicate glass



## Drop S/36L

Suspensión / Pendant Lamp

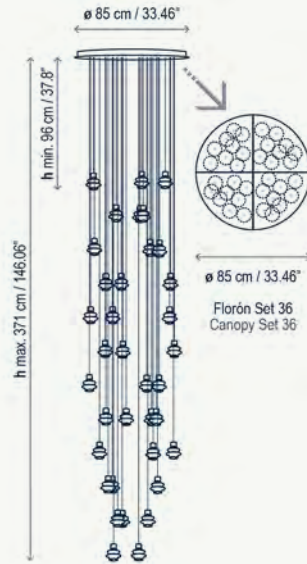

- 2593621056 Ébano Negro - Vidrio Transparente  
Dimable TRIAC  
Black Ebony - Transparente Glass  
Dimmable TRIAC
- 2593621057 Ébano Negro - Vidrio Matizado  
Dimable TRIAC  
Black Ebony - Frosted Glass  
Dimmable TRIAC
- 2593621058 Ébano Negro - Vidrio Verde  
Dimable TRIAC  
Black Ebony - Green Glass  
Dimmable TRIAC
- 2593621059 Ébano Negro - Vidrio Azul  
Dimable TRIAC  
Black Ebony - Blue Glass  
Dimmable TRIAC

Cable coaxial negro, altura máxima 13 mts.  
Black coaxial cable, max. Height 13 mts.

Existen 13 largos de cable estándar para realizar diferentes composiciones. Consultar hoja técnica.  
There are 13 standard cable lengths to make different compositions. Refer to Technical Data Sheet.

No se pueden cortar o manipular los cables / Each light has a different cable length. The cables cannot be cut or handled.

## Drop S/48L

Suspensión / Pendant Lamp

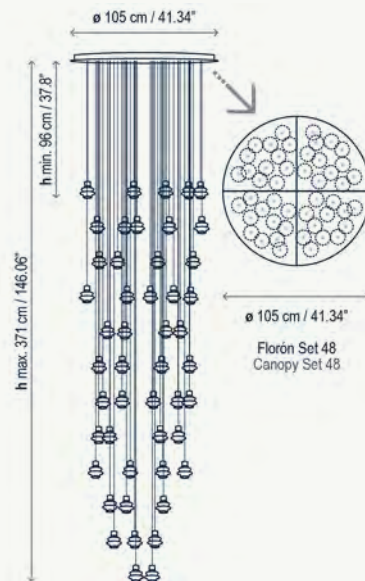

- 2594821056 Ébano Negro - Vidrio Transparente  
Dimable TRIAC  
Black Ebony - Transparente Glass  
Dimmable TRIAC
- 2594821057 Ébano Negro - Vidrio Matizado  
Dimable TRIAC  
Black Ebony - Frosted Glass  
Dimmable TRIAC
- 2594821058 Ébano Negro - Vidrio Verde  
Dimable TRIAC  
Black Ebony - Green Glass  
Dimmable TRIAC
- 2594821059 Ébano Negro - Vidrio Azul  
Dimable TRIAC  
Black Ebony - Blue Glass  
Dimmable TRIAC

Cable coaxial negro, altura máxima 13 mts.  
Black coaxial cable, max. Height 13 mts.

Existen 13 largos de cable estándar para realizar diferentes composiciones. Consultar hoja técnica.  
There are 13 standard cable lengths to make different compositions. Refer to Technical Data Sheet.

No se pueden cortar o manipular los cables / Each light has a different cable length. The cables cannot be cut or handled.

## Acabados Drip / Finishing Drip



Vidrio Transparente  
Transparent Glass

Vidrio Matizado  
Frosted Glass

Vidrio Verde  
Green Glass

Vidrio Azul  
Blue Glass

## Acabados Drop / Finishing Drop

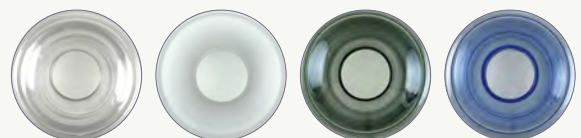

Vidrio Transparente  
Transparent Glass

Vidrio Matizado  
Frosted Glass

Vidrio Verde  
Green Glass

Vidrio Azul  
Blue Glass

# Elea

by Joana Bover | 2013





Las lámparas Elea debido tanto a su formato, como a sus materiales, poliuretano acabado lacado brillante; son un producto absolutamente contemporáneo e intemporal.

*Elea lamps with their shaper as well as their glossy lacquered polyurethane materials, are absolutely contemporary and timeless products.*







## Elea S/55

Suspensión / Pendant Lamp



- 410232401 Blanco Lacado Brillante / *White Brilliant Lacquer*
- 410232422 Rojo Lacado Brillante / *Red Brilliant Lacquer*
- 410232423 Negro Lacado Brillante / *Black Brilliant Lacquer*



- 610232401 Dimable TRIAC - Blanco Lacado Brillante  
*Dimmable TRIAC - White Brilliant Lacquer*
- 610232422 Dimable TRIAC - Rojo Lacado Brillante  
*Dimmable TRIAC - Red Brilliant Lacquer*
- 610232423 Dimable TRIAC - Negro Lacado Brillante  
*Dimmable TRIAC - Black Brilliant Lacquer*

## Elea S/85

Suspensión / Pendant Lamp



- 410332401 Blanco Lacado Brillante / *White Brilliant Lacquer*
- 410332422 Rojo Lacado Brillante / *Red Brilliant Lacquer*
- 410332423 Negro Lacado Brillante / *Black Brilliant Lacquer*
- \*D410332401 Regulable Sistema DALI - Blanco Lacado Brillante  
*DALI Dimming System - White Brilliant Lacquer*
- \*D410332422 Regulable Sistema DALI - Rojo Lacado Brillante  
*DALI Dimming System - Red Brilliant Lacquer*
- \*D410332423 Regulable Sistema DALI - Negro Lacado Brillante  
*DALI Dimming System - Black Brilliant Lacquer*

## Familia / Family



## Materiales / Materials

Poliuretano lacado brillante  
*Brilliant lacquer polyurethane*

## Elea S/95

Suspensión / Pendant Lamp

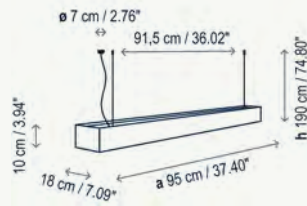

- 3330121101 Blanco Lacado Brillante / *White Brilliant Lacquer*
- 3330121122 Rojo Lacado Brillante / *Red Brilliant Lacquer*
- 3330121123 Negro Lacado Brillante / *Black Brilliant Lacquer*
- \*3330121201 Regulable Sistema DALI / Blanco Lacado Brillante  
*DALI Dimming System / White Brilliant Lacquer*
- \*3330121222 Regulable Sistema DALI / Rojo Lacado Brillante  
*DALI Dimming System / Red Brilliant Lacquer*
- \*3330121223 Regulable Sistema DALI / Negro Lacado Brillante  
*DALI Dimming System / Black Brilliant Lacquer*

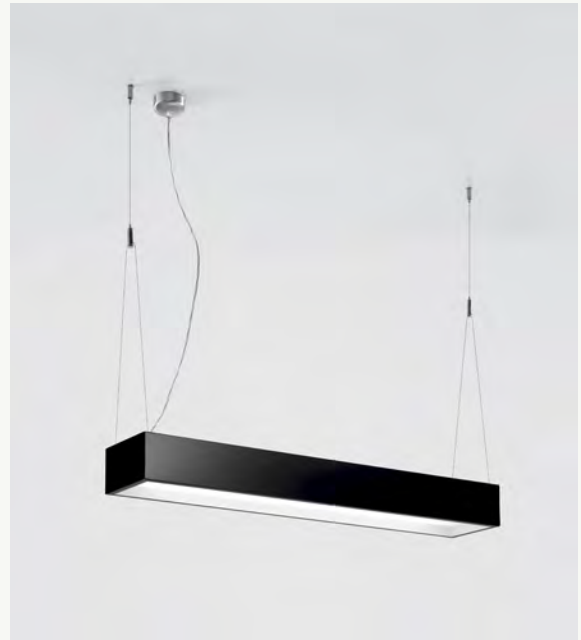

### Difusores / Diffusers

Superior e inferior:  
Cristal Óptico  
Upper & lower:  
Optical Glass

Elea S/55  
Superior: Policarbonato  
Inferior: Cristal Óptico

Elea S/55  
Upper: Polycarbonate  
Lower: Optical Glass

### Acabados / Finishing



Lacado Blanco  
White Lacquer

Lacado Negro  
Black Lacquer

Lacado Rojo  
Red Lacquer

# Elipse

by Alex Fernández Camps / Gonzalo Milà | 2011





### Elipse S/30

Suspensión / Pendant Lamp

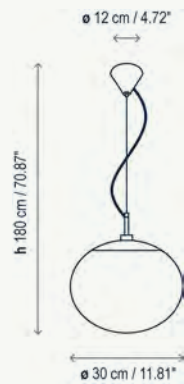

4032301 Bola 30 - Blanco / Ball 30 - White

4032305 Bola 30 - Níquel / Ball 30 - Nickel

### Elipse S/50

Suspensión / Pendant Lamp

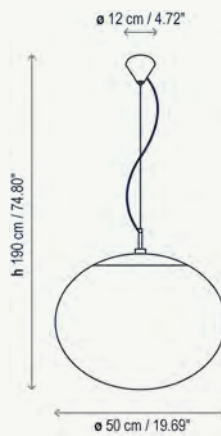
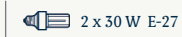

4132301 Bola 50 - Blanco / Ball 50 - White

4132305 Bola 50 - Níquel / Ball 50 - Nickel

Elipse es nuestra lámpara planeta. Su forma de Elipse enriquece los ambientes con una luz confortable y generosa a la vez; tanto de forma individual como combinando diferentes tamaños. La belleza de la sencillez.

*Its our planet lamp. Its elliptical shape enriches spaces with a comfortable and generous light; either individually or by combining different sizes. The beauty of simplicity.*

#### Material / Materials

Aluminio - Polietileno de media densidad  
Aluminum - Medium density polyethylene

#### Familia / Family

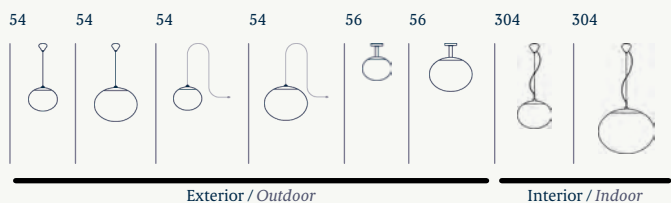

#### Acabados / Finishing



# Garota

by Alex Fernández Camps / Gonzalo Milà | 2015



## Garota S/01

Suspensión / Pendant Lamp



1 x 46 W Classic P Eco E-27

1 x 6 W LED E-27 P48

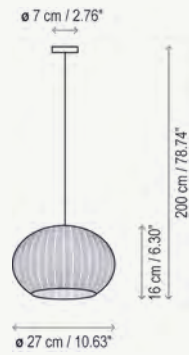

3350120201/P803 Blanco Roto - Pantalla Blanco Marfil  
Natural White - Ivory White Shade

3350120203/P804 Marrón Grafito - Pantalla Marrón  
Brown White - Brown Shade

No incluye globo elipse / Globe not included

Garota, inspirada en el caparazón de un erizo de mar, nos ofrece una luz cálida y tamizada; envuelta en formas orgánicas, redondeadas y sutiles; pensada para acompañarnos en zonas de interior y exterior indistintamente.

Garota, inspired by a sea urchin's shell, offers us a warm and dispersed light; wrapped in organic, rounded and subtle forms; designed to indistinctly accompany us in interior and exterior areas.

### Familia Interior / Indoor Family

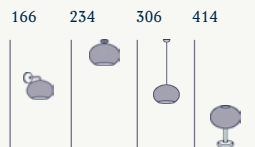

### Familia Exterior / Outdoor Family



### Materiales / Materials

Aluminio - Acero inoxidable - Polietileno - Fibra sintética  
Aluminum - Stainless steel - Polyethylene - Synthetic fiber

Todas las fibras sintéticas utilizadas por Bover son reciclables y no tóxicas para la sostenibilidad del medio ambiente

All synthetic fibers used by Bover are recyclable and non-toxic for environmental sustainability.

### Acabados / Finishing



# Hardy

by Sergi Devesa / Òscar Devesa | 2013

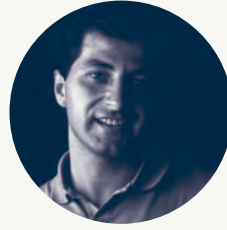



Realizadas en cristal de borosilicato, las Hardy aportan una luz directa, eficiente y sin deslumbramiento. Los dos cilindros concéntricos hacen de la Hardy un colgante simple y elegante con amplias aplicaciones tanto en proyectos residencial como contract.

*Made of borosilicate glass, Hardy provides direct, efficient and glare-free light. The two concentric cylinders make Hardy a simple and elegant pendant with wide applications in both residential and contract projects.*



*Hotel Vincci Bit / Barcelona*

## Hardy

Suspensión / Pendant Lamp

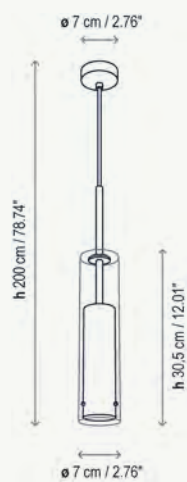

4131206 Cromo - Vidrio / Chrome - Glass

4131221 Blanco - Vidrio / White - Glass

4131299 Dorado - Vidrio / Gold - Glass

Altura regulable / Adjustable height

### Materiales / Materials

Cristal de borosilicato - Hierro - Latón  
 Borosilicate glass - Iron - Brass

### Acabados / Finishing



# Inari

by Joana Bover | 2010







Inari es una colección de lámparas de cristal soplado opal. Su característica principal reside en el grabado de sus líneas irregulares que dan forma y carácter al producto. Inari es una luminaria que emite una luz clara y envolvente que le confiere un alto grado de confort.

*Inari is a collection of opal blown glass lamps, having its main feature on the irregularity of its lines which confer form and character to the product. Inari emits a soft, cozy and diffused light with a great degree of comfort.*



# Inari

Suspensión / Pendant Lamp



3 x 46 W Classic P Eco E-27

3 x 11 W E-27

3 x 6 W LED E-27 P48

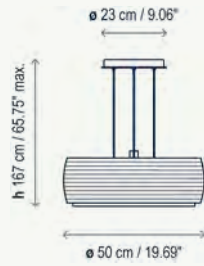

4120205

Níquel-Cristal Opal Grabado  
*Nickel-Opal Glass*

4120206

Cromo-Cristal Opal Grabado  
*Chrome-Opal Glass*

## Familia / Family

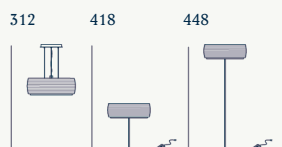

## Difusor / Diffuser

Cristal Óptico  
*Optic Glass*

## Materiales / Materials

Hierro - Cristal soplado  
*Iron - Blown glass*

## Acabados / Finishing

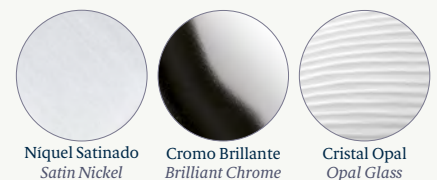

Níquel Satinado  
*Satin Nickel*

Cromo Brillante  
*Brilliant Chrome*

Cristal Opal  
*Opal Glass*

# Lua

by Joana Bover | 2002





Lua es un colgante con tubo telescópico que permite ajustar su longitud. Es una combinación de trabajo artesanal y diseño intemporal; dos características esenciales de Bover. Lua aporta iluminación cálida a cualquier ambiente.



*Lua is a pendant with a telescopic stem that allows you to adjust its length. It is a combination of craftsmanship and timeless design; two of Bover's essential characteristics. Lua brings warm lighting to any environment.*



## Lua 1L

Suspensión / Pendant Lamp

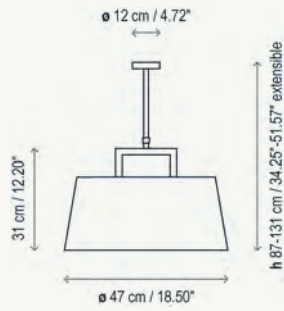

- 4122905/P160C Níquel Satinado - Cotonet  
*Satin Nickel - Cotton*
- 4122905/P183C Níquel Satinado - Cinta Translúcida Crema  
*Satin Nickel - Cream Translucent Ribbon*
- 4122905/P184C Níquel Satinado - Cinta Translúcida Blanca  
*Satin Nickel - White Translucent Ribbon*
- 4122960/P160C Níquel Piel Oscura - Cotonet  
*Nickel Dark Brown Leather - Cotton*
- 4122960/P183C Níquel Piel Oscura  
Cinta Translúcida Crema  
*Nickel Dark Brown Leather  
Cream Translucent Ribbon*
- 4122960/P184C Níquel Piel Oscura  
Cinta Translúcida Blanca  
*Nickel Dark Brown Leather  
White Translucent Ribbon*

Pantalla 47 x 21 x 40 cm / Lampshade 18.50" x 8.27" x 15.75"

## Lua 2L

Suspensión / Pendant Lamp

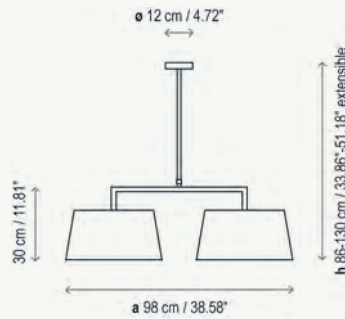

- 4222905/P163C Níquel Satinado - Cotonet  
*Satin Nickel - Cotton*
- 4222905/P167C Níquel Satinado - Cinta Translúcida Crema  
*Satin Nickel - Cream Translucent Ribbon*
- 4222905/P168C Níquel Satinado - Cinta Translúcida Blanca  
*Satin Nickel - White Translucent Ribbon*
- 4222960/P163C Níquel Piel Oscura - Cotonet  
*Nickel Dark Brown Leather - Cotton*
- 4222960/P167C Níquel Piel Oscura  
Cinta Translúcida Crema  
*Nickel Dark Brown Leather  
Cream Translucent Ribbon*
- 4222960/P168C Níquel Piel Oscura  
Cinta Translúcida Blanca  
*Nickel Dark Brown Leather  
White Translucent Ribbon*

Pantalla 38 x 20 x 30 cm / Lampshade 14.96" x 7.87" x 11.81"

### Diffusor / Diffuser

Superior: Metacrilato  
*Upper: Methacrylate*

### Materiales / Materials

Latón - Hierro  
*Brass - Iron*

### Acabados / Finishing



Níquel Satinado  
*Satin Nickel*

Piel Oscura  
*Dark Leather*

Cotonet  
*Cotton*

Cinta Crema  
*Cream Ribbon*

Cinta Blanca  
*White Ribbon*

# Mar

by Joana Bover | 2004







Mar es una lámpara de suspensión serena y decorativa, con una estructura lineal de formas lisas que nos ofrece una luz directa y confortable.

*Mar is a straightforward decorative pendant lamp, with linear and clean shapes. MAR offers a direct and comfortable light.*



*Difusor / Diffuser*

Inferior: PVC 500  
Lower: PVC 500

*Materiales / Materials*

Hierro - Piel  
Iron - Leather

## Mar

Suspensión / Pendant Lamp



3 x 46 W Classic P Eco E-27

3 x 11 W E-27

3 x 6 W LED E-27 P48

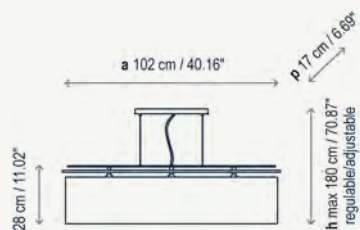

4324405T/P521 Níquel Satinado - Cinta Translúcida Crema  
*Satin Nickel - Cream Translucent Ribbon*

4324405T/P522 Níquel Satinado - Cinta Translúcida Blanca  
*Satin Nickel - White Translucent Ribbon*

4324405T/P523 Níquel Satinado - Cinta Translúcida Roja  
*Satin Nickel - Red Translucent Ribbon*

4324405T/P524 Níquel Satinado - Cotonet  
*Satin Nickel - Cotton*

4324460/P521 Níquel Piel Oscura  
Cinta Translúcida Crema  
*Nickel Dark Brown Leather  
Cream Translucent Ribbon*

4324460/P522 Níquel Piel Oscura  
Cinta Translúcida Blanca  
*Nickel Dark Brown Leather  
White Translucent Ribbon*

4324460/P523 Níquel Piel Oscura  
Cinta Translúcida Roja  
*Nickel Dark Brown Leather  
Red Translucent Ribbon*

4324460/P524 Níquel Piel Oscura - Cotonet  
*Nickel Dark Brown Leather - Cotton*

Pantalla rectangular plana 100 x 17 cm.  
*Rectangular lampshade 39.37" x 6.69".*

### Acabados / Finishing



Níquel Satinado  
*Satin Nickel*



Piel Oscura  
*Dark Leather*



Cotonet  
*Cotton*

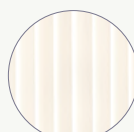

Cinta Crema  
*Cream Ribbon*



Cinta Blanca  
*White Ribbon*



Cinta Roja  
*Red Ribbon*

# Marietta

by Joana Bover | 2015





Marietta es una brillante interpretación de las clásicas campanas de suspensión industriales, que a principios del siglo XX iluminaban la mayor parte de los talleres y fábricas de Europa. Marietta es una lámpara de gran formato. Es contemporánea, decorativa, cálida y envolvente. Capaz de adaptarse a cualquier entorno y convivir con otros productos en ocasiones más puristas y menos presenciales.

*Marietta is an outstanding interpretation of the classical industrial lights installed in most of the warehouses and factories in Europe during the beginning of the Twentieth Century. Marietta is warm, contemporary and decorative. It can adapt to any environment and live together with other products without distraction.*

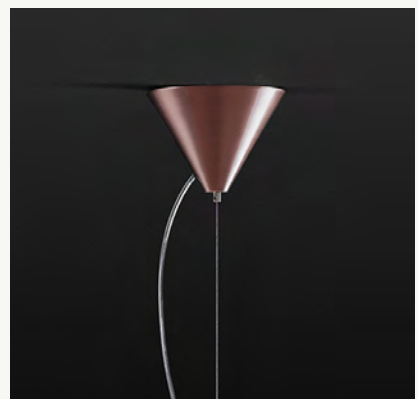
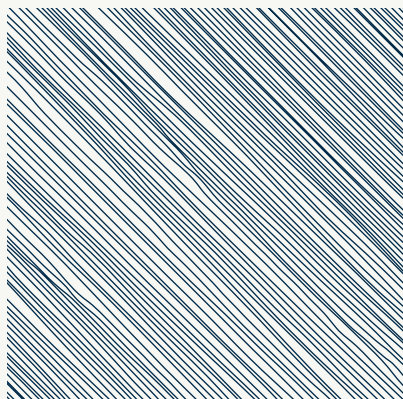



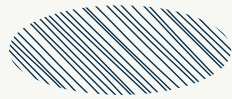
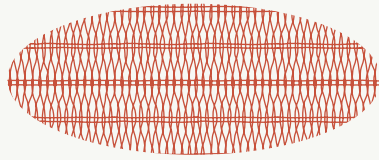





## Marietta 90

Suspensión / Pendant Lamp

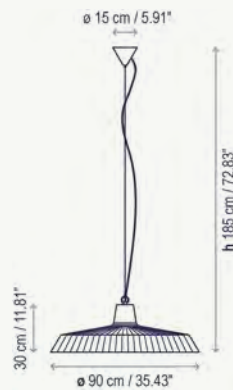

- 3310220262/P785 Aluminio Satinado - Cinta Translúcida Blanca  
*Satin Aluminum - White Translucent Ribbon*
- 3310220262/P786 Aluminio Satinado - Cinta Translúcida Crema  
*Satin Aluminum - Cream Translucent Ribbon*
- 3310220262/P787 Aluminio Satinado - Cinta Translúcida Roja  
*Satin Aluminum - Red Translucent Ribbon*
- 3310220262/P826 Aluminio Satinado - Cinta Translúcida Negra  
*Satin Aluminum - Black Translucent Ribbon*
- 3310220289/P785 Cobre Satinado - Cinta Translúcida Blanca  
*Satin Copper - White Translucent Ribbon*
- 3310220289/P786 Cobre Satinado - Cinta Translúcida Crema  
*Satin Copper - Cream Translucent Ribbon*
- 3310220289/P787 Cobre Satinado - Cinta Translúcida Roja  
*Satin Copper - Red Translucent Ribbon*
- 3310220289/P826 Cobre Satinado - Cinta Translúcida Negra  
*Satin Copper - Black Translucent Ribbon*

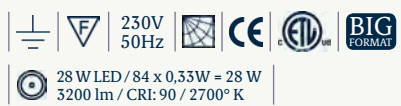

- 3310220862/P785 Aluminio Satinado - Cinta Translúcida Blanca  
*Satin Aluminum - White Translucent Ribbon*
- 3310220862/P786 Aluminio Satinado - Cinta Translúcida Crema  
*Satin Aluminum - Cream Translucent Ribbon*
- 3310220862/P787 Aluminio Satinado - Cinta Translúcida Roja  
*Satin Aluminum - Red Translucent Ribbon*
- 3310220862/P826 Aluminio Satinado - Cinta Translúcida Negra  
*Satin Aluminum - Black Translucent Ribbon*
- 3310220889/P785 Cobre Satinado - Cinta Translúcida Blanca  
*Satin Copper - White Translucent Ribbon*
- 3310220889/P786 Cobre Satinado - Cinta Translúcida Crema  
*Satin Copper - Cream Translucent Ribbon*
- 3310220889/P787 Cobre Satinado - Cinta Translúcida Roja  
*Satin Copper - Red Translucent Ribbon*
- 3310220889/P826 Cobre Satinado - Cinta Translúcida Negra  
*Satin Copper - Black Translucent Ribbon*

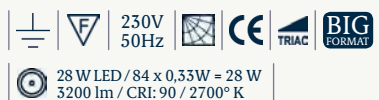

- 3310221562/P785 Dimable TRIAC - Aluminio Satinado  
Cinta Translúcida Blanca  
*Dimmable TRIAC - Satin Aluminum  
White Translucent Ribbon*
- 3310221562/P786 Dimable TRIAC - Aluminio Satinado  
Cinta Translúcida Crema  
*Dimmable TRIAC - Satin Aluminum  
Cream Translucent Ribbon*
- 3310221562/P787 Dimable TRIAC - Aluminio Satinado  
Cinta Translúcida Roja  
*Dimmable TRIAC - Satin Aluminum  
Red Translucent Ribbon*
- 3310221562/P826 Dimable TRIAC - Aluminio Satinado  
Cinta Translúcida Negra  
*Dimmable TRIAC - Satin Aluminum  
Black Translucent Ribbon*
- 3310221589/P785 Dimable TRIAC - Cobre Satinado  
Cinta Translúcida Blanca  
*Dimmable TRIAC - Satin Copper  
White Translucent Ribbon*
- 3310221589/P786 Dimable TRIAC - Cobre Satinado  
Cinta Translúcida Crema  
*Dimmable TRIAC - Satin Copper  
Cream Translucent Ribbon*
- 3310221589/P787 Dimable TRIAC - Cobre Satinado  
Cinta Translúcida Roja  
*Dimmable TRIAC - Satin Copper  
Red Translucent Ribbon*
- 3310221589/P826 Dimable TRIAC - Cobre Satinado  
Cinta Translúcida Negra  
*Dimmable TRIAC - Satin Copper  
Black Translucent Ribbon*

### Material / Materials

Aluminio - Hierro  
*Aluminum - Iron*

### Difusor / Diffuser

Polycarbonato  
*Polycarbonate*

### Familia / Family



Exterior  
*Outdoor*

Interior  
*Indoor*

## Marietta 120

Suspensión / Pendant Lamp

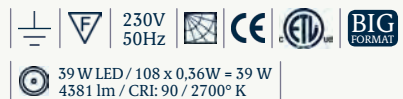

- 3310320262/P788 Aluminio Satinado - Cinta Translúcida Blanca  
*Satin Aluminum - White Translucent Ribbon*
- 3310320262/P789 Aluminio Satinado - Cinta Translúcida Crema  
*Satin Aluminum - Cream Translucent Ribbon*
- 3310320262/P800 Aluminio Satinado - Cinta Translúcida Roja  
*Satin Aluminum - Red Translucent Ribbon*
- 3310320262/P827 Aluminio Satinado - Cinta Translúcida Negra  
*Satin Aluminum - Black Translucent Ribbon*
- 3310320289/P788 Cobre Satinado - Cinta Translúcida Blanca  
*Satin Copper - White Translucent Ribbon*
- 3310320289/P789 Cobre Satinado - Cinta Translúcida Crema  
*Satin Copper - Cream Translucent Ribbon*
- 3310320289/P800 Cobre Satinado - Cinta Translúcida Roja  
*Satin Copper - Red Translucent Ribbon*
- 3310320289/P827 Cobre Satinado - Cinta Translúcida Negra  
*Satin Copper - Black Translucent Ribbon*

- 3310320862/P788 Aluminio Satinado - Cinta Translúcida Blanca  
*Satin Aluminum - White Translucent Ribbon*
- 3310320862/P789 Aluminio Satinado - Cinta Translúcida Crema  
*Satin Aluminum - Cream Translucent Ribbon*
- 3310320862/P800 Aluminio Satinado - Cinta Translúcida Roja  
*Satin Aluminum - Red Translucent Ribbon*
- 3310320862/P827 Aluminio Satinado - Cinta Translúcida Negra  
*Satin Aluminum - Black Translucent Ribbon*
- 3310320889/P788 Cobre Satinado - Cinta Translúcida Blanca  
*Satin Copper - White Translucent Ribbon*
- 3310320889/P789 Cobre Satinado - Cinta Translúcida Crema  
*Satin Copper - Cream Translucent Ribbon*
- 3310320889/P800 Cobre Satinado - Cinta Translúcida Roja  
*Satin Copper - Red Translucent Ribbon*
- 3310320889/P827 Cobre Satinado - Cinta Translúcida Negra  
*Satin Copper - Black Translucent Ribbon*

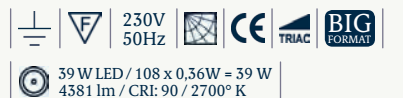

- 3310321562/P788 Dimable TRIAC - Aluminio Satinado  
Cinta Translúcida Blanca  
*Dimmable TRIAC - Satin Aluminum  
White Translucent Ribbon*
- 3310321562/P789 Dimable TRIAC - Aluminio Satinado  
Cinta Translúcida Crema  
*Dimmable TRIAC - Satin Aluminum  
Cream Translucent Ribbon*
- 3310321562/P800 Dimable TRIAC - Aluminio Satinado  
Cinta Translúcida Roja  
*Dimmable TRIAC - Satin Aluminum  
Red Translucent Ribbon*
- 3310321562/P827 Dimable TRIAC - Aluminio Satinado  
Cinta Translúcida Negra  
*Dimmable TRIAC - Satin Aluminum  
Black Translucent Ribbon*
- 3310321589/P788 Dimable TRIAC - Cobre Satinado  
Cinta Translúcida Blanca  
*Dimmable TRIAC - Satin Copper  
White Translucent Ribbon*
- 3310321589/P789 Dimable TRIAC - Cobre Satinado  
Cinta Translúcida Crema  
*Dimmable TRIAC - Satin Copper  
Cream Translucent Ribbon*
- 3310321589/P800 Dimable TRIAC - Cobre Satinado  
Cinta Translúcida Roja  
*Dimmable TRIAC - Satin Copper  
Red Translucent Ribbon*
- 3310321589/P827 Dimable TRIAC - Cobre Satinado  
Cinta Translúcida Negra  
*Dimmable TRIAC - Satin Copper  
Black Translucent Ribbon*

### Acabados / Finishing

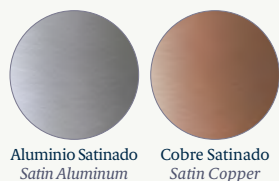

# Maxi

by Joana Bover | 2004





Elegante, sutil e imponente;  
Maxi aporta iluminación  
cálida y diseño intemporal,  
que se adapta sin  
estridentes al paso del  
tiempo sin perder su acento  
contemporáneo.

*Elegant, subtle and imposing;  
Maxi provides warm lighting  
and timeless design, which  
gracefully adapts to the  
passage of time without losing  
its contemporary feel.*



*S.T. OR Lighting / Israel*





## Maxi S/01

Suspensión / Pendant Lamp

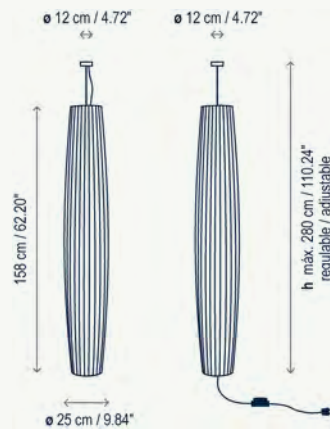

- 43195TOP/P507T Instalación Superior - Níquel Satinado  
Cinta Translúcida Crema  
*Electrical Upper Installation - Satin Nickel  
Cream Translucent Ribbon*
- 43195TOP/P508T Instalación Superior - Níquel Satinado  
Cinta Translúcida Blanca  
*Electrical Upper Installation - Satin Nickel  
White Translucent Ribbon*
- 4319505/P507I Instalación Inferior - Níquel Satinado  
Cinta Translúcida Crema  
*Electrical Bottom Installation - Satin Nickel  
Cream Translucent Ribbon*
- 4319505/P508I Instalación Inferior - Níquel Satinado  
Cinta Translúcida Blanca  
*Electrical Bottom Installation - Satin Nickel  
White Translucent Ribbon*

Pantalla 158 x 25 cm / Lampshade 62.20" x 9.84"

## Maxi S/02

Suspensión / Pendant Lamp

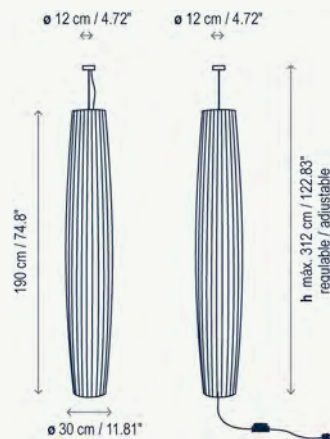

- 44195TOP/P506T Instalación Superior - Níquel Satinado  
Cinta Translúcida Crema  
*Electrical Upper Installation - Satin Nickel  
Cream Translucent Ribbon*
- 44195TOP/P509T Instalación Superior - Níquel Satinado  
Cinta Translúcida Blanca  
*Electrical Upper Installation - Satin Nickel  
White Translucent Ribbon*
- 4419505/P506I Instalación Inferior - Níquel Satinado  
Cinta Translúcida Crema  
*Electrical Bottom Installation - Satin Nickel  
Cream Translucent Ribbon*
- 4419505/P509I Instalación Inferior - Níquel Satinado  
Cinta Translúcida Blanca  
*Electrical Bottom Installation - Satin Nickel  
White Translucent Ribbon*

Pantalla 190 x 30 cm / Lampshade 74.8" x 11.81"

Altura regulable cable tensor con seguro / Adjustable tensor wire  
Florón níquel (sólo para instalación superior) / Nickel canopy  
(only for upper installation)  
Bombillas Eco Classic incluidas / Eco Classic bulbs included

## Familia / Family





## Maxi S/03

Suspensión / Pendant Lamp

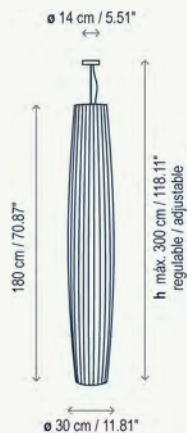

4303195TOP/P754T

Instalación Superior  
Regulable Sistema DALI  
Níquel Satinado - Cinta Translúcida Crema  
Electrical Upper Installation  
DALI Dimming System  
Satin Nickel - Cream Translucent Ribbon

4303195TOP/P755T

Instalación Superior  
Regulable Sistema DALI  
Níquel Satinado - Cinta Translúcida Blanca  
Electrical Upper Installation  
DALI Dimming System  
Satin Nickel - White Translucent Ribbon

Pantalla 180 x 30 cm / Lampshade 70.87" x 11.81"

### Materiales / Materials

Hierro - Latón  
Iron - Brass

### Acabados / Finishing

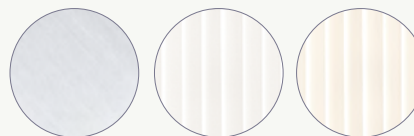

Níquel Satinado  
Satin Nickel

Cinta Blanca  
White Ribbon

Cinta Crema  
Cream Ribbon

# Mei

by Joana Bover | 2004





Heather Dubbeldam Architects

En las Mei, la pantalla de cinta hecha a mano tiene un absoluto protagonismo. Las lámparas Mei resultan ideales para crear ambientes amables donde se requiera una luz cálida y rica en matices.

*In Mei, the handmade ribbon work is more prominent. Mei lamps are ideal for creating friendly environments where warm and rich light is required.*



*Danone / Barcelona*



## Mei 38

Suspensión / Pendant Lamp



1 x 46 W Classic P Eco E-27

1 x 11 W E-27

1 x 9 W LED E-27 A60



4219905/P505C Níquel Satinado - Cinta Translúcida Blanca  
*Satin Nickel - White Translucent Ribbon*

4219905/P504C Níquel Satinado - Cinta Translúcida Crema  
*Satin Nickel - Cream Translucent Ribbon*

4219905/P495C Níquel Satinado - Cinta Translúcida Rojo  
*Satin Nickel - Red Translucent Ribbon*

## Mei 60

Suspensión / Pendant Lamp



1 x 77 W Classic A Eco E-27

1 x 18 W E-27

1 x 9 W LED E-27 A60



4119905/P503C Níquel Satinado - Cinta Translúcida Blanca  
*Satin Nickel - White Translucent Ribbon*

4119905/P502C Níquel Satinado - Cinta Translúcida Crema  
*Satin Nickel - Cream Translucent Ribbon*

4119905/P501C Níquel Satinado - Cinta Translúcida Rojo  
*Satin Nickel - Red Translucent Ribbon*

4119905/P496C Níquel Satinado - Cinta Translúcida Negra  
*Satin Nickel - Black Translucent Ribbon*

## Mei 90

Suspensión / Pendant Lamp



3 x 77 W Classic A Eco E-27

3 x 22 W E-27

3 x 9 W LED E-27 A60

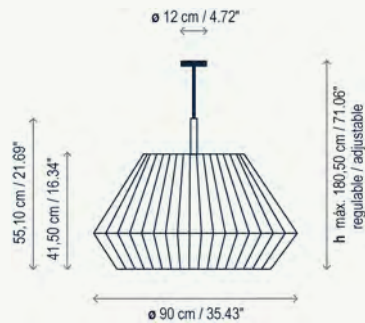

4419905/P490C Níquel Satinado - Cinta Translúcida Blanca  
*Satin Nickel - White Translucent Ribbon*

4419905/P491C Níquel Satinado - Cinta Translúcida Crema  
*Satin Nickel - Cream Translucent Ribbon*

4419905/P493C Níquel Satinado - Cinta Translúcida Rojo  
*Satin Nickel - Red Translucent Ribbon*

4419905/P492C Níquel Satinado - Cinta Translúcida Negra  
*Satin Nickel - Black Translucent Ribbon*

## Mei 125

Suspensión / Pendant Lamp

- 
- 
-  5 x 77 W Classic A Eco E-27
-  5 x 22 W E-27
-  5 x 9 W LED E-27 A60

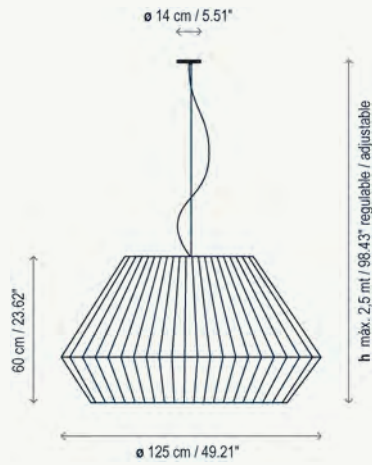

- 4719905/P720C Níquel Satinado - Cinta Translúcida Blanca  
*Satin Nickel - White Translucent Ribbon*
- 4719905/P721C Níquel Satinado - Cinta Translúcida Crema  
*Satin Nickel - Cream Translucent Ribbon*
- 4719905/P722C Níquel Satinado - Cinta Translúcida Rojo  
*Satin Nickel - Red Translucent Ribbon*
- 4719905/P723C Níquel Satinado - Cinta Translúcida Negra  
*Satin Nickel - Black Translucent Ribbon*

## Mei 150

Suspensión / Pendant Lamp

- 
- 
-  6 x 77 W Classic A Eco E-27
-  6 x 30 W E-27
-  6 x 9 W LED E-27 A60

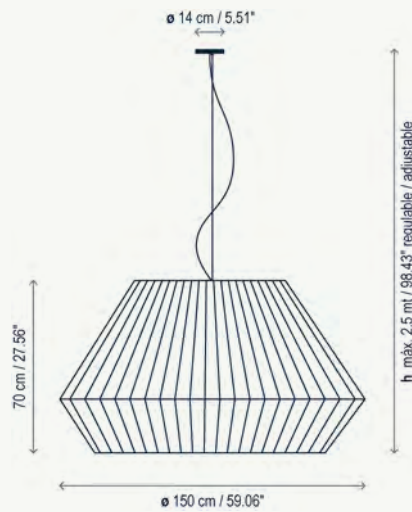

- 4619905/P590C Níquel Satinado - Cinta Translúcida Blanca  
*Satin Nickel - White Translucent Ribbon*
- 4619905/P591C Níquel Satinado - Cinta Translúcida Crema  
*Satin Nickel - Cream Translucent Ribbon*
- 4619905/P592C Níquel Satinado - Cinta Translúcida Rojo  
*Satin Nickel - Red Translucent Ribbon*
- 4619905/P593C Níquel Satinado - Cinta Translúcida Negra  
*Satin Nickel - Black Translucent Ribbon*

### Difusor / Diffuser

Inferior: PVC 500  
Lower: PVC 500

### Materiales / Materials

Hierro  
Iron

### Acabados / Finishing



Níquel Satinado  
*Satin Nickel*

Cinta Blanca  
*White Ribbon*

Cinta Crema  
*Cream Ribbon*

Cinta Roja  
*Red Ribbon*

Cinta Negra  
*Black Ribbon*







## Mei 100

Suspensión / Pendant Lamp



230V  
50Hz



3 x 46 W Classic P Eco E-27

3 x 11 W E-27  
Duluxstar Mini Twist

3 x 6 W LED E-27 P48

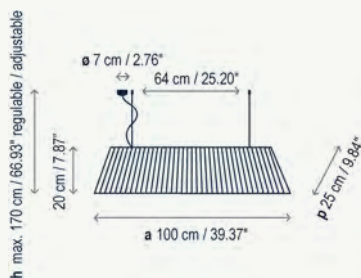

4319905/P584C Níquel Satinado - Cinta Translúcida Blanca  
*Satin Nickel - White Translucent Ribbon*

4319905/P497C Níquel Satinado - Cinta Translúcida Crema  
*Satin Nickel - Cream Translucent Ribbon*

4319905/P585C Níquel Satinado - Cinta Translúcida Rojo  
*Satin Nickel - Red Translucent Ribbon*

4319905/P586C Níquel Satinado - Cinta Translúcida Negra  
*Satin Nickel - Black Translucent Ribbon*

4319905/P498C Níquel Satinado - Cotonet  
*Satin Nickel - Cotton*

4319905/P499C Níquel Satinado - Lino  
*Satin Nickel - Linen*

## Mei 120

Suspensión / Pendant Lamp



230V  
50Hz



5 x 46 W Classic P Eco E-27

5 x 11 W E-27  
Duluxstar Mini Twist

5 x 6 W LED E-27 P48



4519905/P514C Níquel Satinado - Cinta Translúcida Blanca  
*Satin Nickel - White Translucent Ribbon*

4519905/P510C Níquel Satinado - Cinta Translúcida Crema  
*Satin Nickel - Cream Translucent Ribbon*

4519905/P522C Níquel Satinado - Cinta Translúcida Rojo  
*Satin Nickel - Red Translucent Ribbon*

4519905/P523C Níquel Satinado - Cinta Translúcida Negra  
*Satin Nickel - Black Translucent Ribbon*

4519905/P511C Níquel Satinado - Cotonet  
*Satin Nickel - Cotton*

4519905/P512C Níquel Satinado - Lino  
*Satin Nickel - Linen*

## Difusor / Diffuser

Inferior: PVC 500  
Lower: PVC 500

## Materiales / Materials

Hierro  
Iron

## Mei 180

Suspensión / Pendant Lamp



6 x 46 W Classic P Eco E-27

6 x 11 W E-27  
Duluxstar Mini Twist

6 x 6 W LED E-27 P48

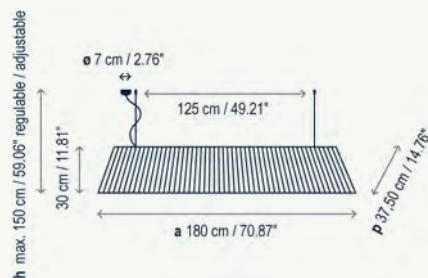

- 430319905/P759C Níquel Satinado - Cinta Translúcida Blanca  
*Satin Nickel - White Translucent Ribbon*
- 430319905/P756C Níquel Satinado - Cinta Translúcida Crema  
*Satin Nickel - Cream Translucent Ribbon*
- 430319905/P760C Níquel Satinado - Cinta Translúcida Rojo  
*Satin Nickel - Red Translucent Ribbon*
- 430319905/P761C Níquel Satinado - Cinta Translúcida Negra  
*Satin Nickel - Black Translucent Ribbon*
- 430319905/P757C Níquel Satinado - Cotonet  
*Satin Nickel - Cotton*
- 430319905/P758C Níquel Satinado - Lino  
*Satin Nickel - Linen*

Altura regulable cable tensor con seguro / *Adjustable tensor wire*

### Acabados / Finishing



Níquel Satinado  
*Satin Nickel*

Cinta Blanca  
*White Ribbon*

Cinta Crema  
*Cream Ribbon*

Cinta Roja  
*Red Ribbon*

Cinta Negra  
*Black Ribbon*

Cotonet  
*Cotton*

Lino  
*Linen*

# Mos

by Joana Bover | 2008



*Hotel Vincci Condal Mar / Barcelona*



Hostal Empúries / L'Escala

Mos es una generosa estructura romboidal compuesta por pantallas de cinta hechas a mano. Su intemporalidad y gran versatilidad permiten instalarla en todo tipo ambientes; tanto residenciales como contract.

*Mos is a generous rhomboidal structure made of handmade ribbon shades. Its timelessness and great versatility allow it to be installed in all types of environments; both residential and commercial.*



*Poliform / Italy*

### Mos 01

Suspensión / Pendant Lamp



3 x 46 W Classic P Eco E-27

3 x 18 W E-27

3 x 9 W LED E-27 A60

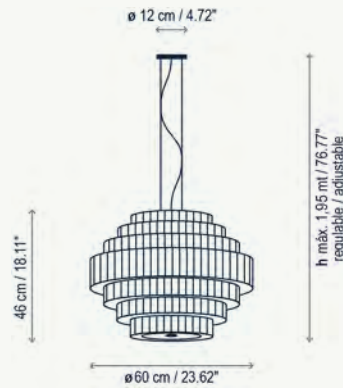

- 224P617 Cinta Translúcida Blanca  
*White Translucent Ribbon*
- 224P618 Cinta Translúcida Crema  
*Cream Translucent Ribbon*
- 224P619 Cinta Translúcida Roja  
*Red Translucent Ribbon*

### Mos 02

Suspensión / Pendant Lamp



5 x 46 W Classic P Eco E-27

5 x 30 W E-27

5 x 9 W LED E-27 A60

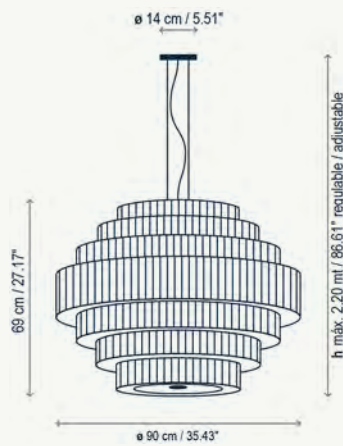

- 224P622 Cinta Translúcida Blanca  
*White Translucent Ribbon*
- 224P623 Cinta Translúcida Crema  
*Cream Translucent Ribbon*
- 224P624 Cinta Translúcida Roja  
*Red Translucent Ribbon*

### Mos 03

Suspensión / Pendant Lamp



6 x 77 W Classic A Eco E-27

6 x 30 W E-27

6 x 9 W LED E-27 A60

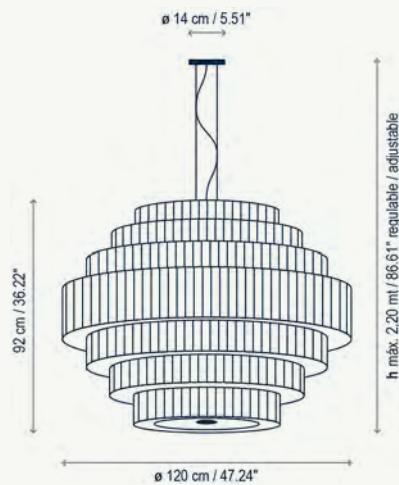

- 224P621 Cinta Translúcida Blanca  
*White Translucent Ribbon*
- 224P625 Cinta Translúcida Crema  
*Cream Translucent Ribbon*
- 224P626 Cinta Translúcida Roja  
*Red Translucent Ribbon*

Cable conexión transparente / *Transparent connection cable*  
 Altura regulable / *Adjustable height*  
 Cable tensor + seguro / *Safety tensor wire*

#### Difusor / Diffuser

Mos 01 - Mos 02:  
Cristal óptico / *Optical glass*

Mos 03:  
Policarbonato / *Polycarbonate*

#### Materiales / Materials

Hierro  
*Iron*

#### Acabados / Finishing



Cinta Blanca  
*White Ribbon*

Cinta Crema  
*Cream Ribbon*

Cinta Roja  
*Red Ribbon*

# Nón Lá

by Jorge Pensi Design Studio | 2015





**BEST of year** INTERIOR DESIGN  
HONOREE 2015

Nón Lá es nuestra manera de rendirle un pequeño homenaje al sombrero vietnamita y a su cultura centenaria. Su sencillo cono abierto, nos ofrece una estructura ligera, resistente y un punto vanguardista gracias a la descentralidad de su cavidad lumínica.

“La manera en que la poesía se mezcla con la tecnología es lo que realmente me gusta.”

*Non La is our way of paying a little homage to the Vietnamese hat and its centenary culture. Its simple open cone offers us a light structure that is resistant and a bit avant-garde, thanks to the decentralization of its light cavity.*

*"What I really like is the way that poetry mixes with technology"*











## Nón Lá S

Suspensión / Pendant Lamp

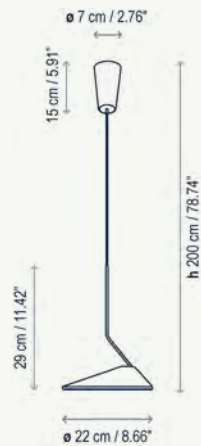

- 3320121501 Dimable TRIAC - Blanco Lacado Brillante  
Florón Blanco - Cable Blanco  
*Dimmable TRIAC - Brilliant White Lacquer  
White Canopy - White Cable*
- 3320121506 Dimable TRIAC - Cromo Brillante  
Florón Blanco - Cable Transp.  
*Dimmable TRIAC - Brilliant Chrome  
White Canopy - Transp. Cable*
- 3320121590 Dimable TRIAC - Cobre Brillante  
Florón Negro - Cable Negro  
*Dimmable TRIAC - Brilliant Copper  
Black Canopy - Black Cable*

## Nón Lá Set 3/Circular

Suspensión / Pendant Lamp

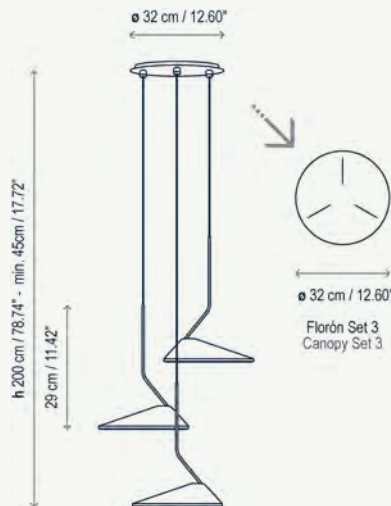

- 3320321501 Dimable TRIAC - Blanco Lacado Brillante  
Florón Blanco - Cable Blanco  
*Dimmable TRIAC - Brilliant White Lacquer  
White Canopy - White Cable*
- 3320321506 Dimable TRIAC - Cromo Brillante  
Florón Blanco - Cable Transparente  
*Dimmable TRIAC - Brilliant Chrome  
White Canopy - Transparent Cable*
- 3320321590 Dimable TRIAC - Cobre Brillante  
Florón Negro - Cable Negro  
*Dimmable TRIAC - Brilliant Copper  
Black Canopy - Black Cable*

## Familia / Family

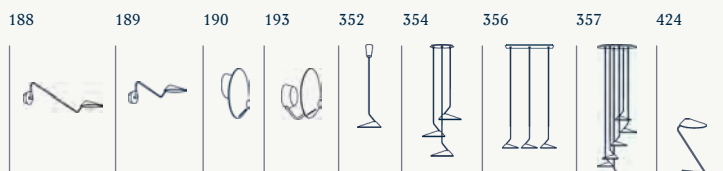

## Nón Lá Set 3/Rectangular

Suspensión / Pendant Lamp

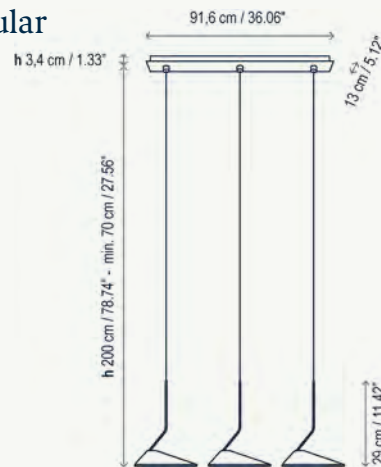

3320421501 Dimable TRIAC - Blanco Lacado Brillante  
 Florón Blanco - Cable Blanco  
*Dimmable TRIAC - Brilliant White Lacquer  
 White Canopy - White Cable*

3320421506 Dimable TRIAC - Cromo Brillante  
 Florón Blanco - Cable Transparente  
*Dimmable TRIAC - Brilliant Chrome  
 White Canopy - Transparent Cable*

3320421590 Dimable TRIAC - Cobre Brillante  
 Florón Negro - Cable Negro  
*Dimmable TRIAC - Brilliant Copper  
 Black Canopy - Black Cable*

## Nón Lá Set 6/Circular

Suspensión / Pendant Lamp

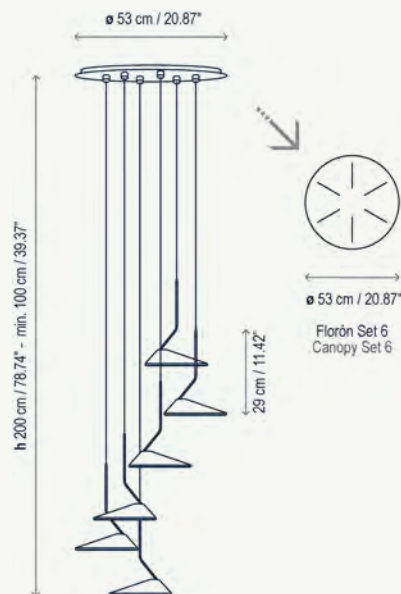

3320621501 Dimable TRIAC - Blanco Lacado Brillante  
 Florón Blanco - Cable Blanco  
*Dimmable TRIAC - Brilliant White Lacquer  
 White Canopy - White Cable*

3320621506 Dimable TRIAC - Cromo Brillante  
 Florón Blanco - Cable Transparente  
*Dimmable TRIAC - Brilliant Chrome  
 White Canopy - Transparent Cable*

3320621590 Dimable TRIAC - Cobre Brillante  
 Florón Negro - Cable Negro  
*Dimmable TRIAC - Brilliant Copper  
 Black Canopy - Black Cable*

### Materiales / Materials

Aluminio  
 Aluminum

Cable coaxial negro  
 Black coaxial cable

### Difusor / Diffuser

Metacrilato  
 Methacrylate

### Acabados / Finishing



Lacado Blanco  
 White Lacquer

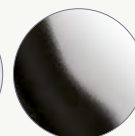

Cromo Brillante  
 Brilliant Chrome

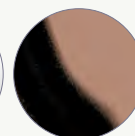

Cobre Brillante  
 Brilliant copper

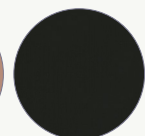

Negro Grafito  
 Graphite Black

# Oliver

by Sergi Devesa / Òscar Devesa | 2013

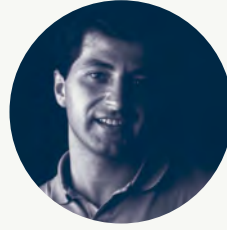

*Coquinaria / Santa Agnès de Malanyanes*





Oliver consiste en una de las típicas pantallas de Bover recubierta por un cristal de borosilicato; el resultado es una elegante lámpara que ofrece tanto luz directa como de ambiente. Al estar la pantalla textil protegida del polvo, la hace además ideal para proyectos contract.

*Oliver consists of one of the typical Bover shades covered by borosilicate glass; the result is an elegant lamp that offers both direct and ambient light. As the textile shade is protected from dust, it is also ideal for commercial projects.*



# Oliver S

Plafón / Ceiling Lamp

- 

230V  
50Hz
- 

1 x 15 W E-27 CFL
- 
1 x 6 W LED E-27 P48

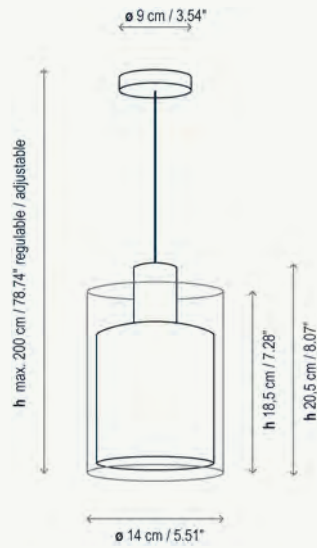

- 4131306/P734C Cromo - Cinta Translúcida Blanca  
*Chrome - White Translucent Ribbon*
- 4131306/P735C Cromo - Cinta Translúcida Crema  
*Chrome - Cream Translucent Ribbon*
- 4131306/P736C Cromo - Cinta Translúcida Rojo  
*Chrome - Red Translucent Ribbon*
- 4131306/P737C Cromo - Cotonet Blanco  
*Chrome - White Cotton*
- 4131306/P738C Cromo - Cotonet Negro  
*Chrome - Black Cotton*

Pantalla 12 x 13 cm / Lampshade 4.72"x 5.12"

Conexión transparente / Transparent connection  
Altura regulable / Adjustable height

## Familia / Family



## Materiales / Materials

Vidrio borosilicato - Hierro  
*Borosilicate glass - Iron*

## Acabados / Finishing



# Oval

by Joana Bover | 2006



## Oval S/100

Suspensión / Pendant Lamp



3 x 46 W Classic P Eco E-27

3 x 11 W E-27 Duluxstar Mini Twist

3 x 6 W LED E-27 P48

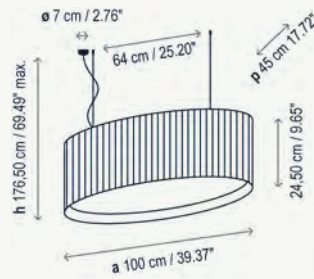

4319905/P545C Níquel Satinado - Cinta Translúcida Blanca  
*Satin Nickel - White Translucent Ribbon*

4319905/P546C Níquel Satinado - Cinta Translúcida Crema  
*Satin Nickel - Cream Translucent Ribbon*

4319905/P547C Níquel Satinado - Cinta Translúcida Negra  
*Satin Nickel - Black Translucent Ribbon*

4319905/P548C Cotonet Blanco  
*Satin Nickel - White Cotton*

Altura regulable cable tensor con seguro / *Adjustable tensor wire*

Oval es una lámpara de suspensión simple y elegante que ofrece luz cálida a través de su pantalla de cinta hecha a mano.

*Oval is a simple and elegant suspension lamp that offers warm light through its handmade ribbon work.*



### Difusor / Diffuser

Inferior: PVC 500  
*Lower: PVC 500*

### Materiales / Materials

Hierro  
*Iron*

### Familia / Family



### Acabados / Finishing



Níquel Satinado  
*Satin Nickel*

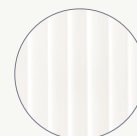

Cinta Blanca  
*White Ribbon*



Cinta Crema  
*Cream Ribbon*



Cinta Negra  
*Black Ribbon*



Cotonet Blanco  
*White Cotton*

# Penta

by Gonzalo Milà / Juan Carlos Ines | 2017



“La premisa era hacer una lámpara con la que se pudieran tener conversaciones alrededor de una mesa viendo las caras de las personas con las que hablas, que no deslumbrara”. Penta no solo encuentra fácilmente su lugar en el hogar; sino que también se adapta perfectamente al ambiente de un hotel o a cualquier tipo de proyecto dentro del sector Contract.

*“The premise was to make a lamp with which you could have conversations around a table looking at the faces of the people that you’re talking to”. A lamp that without glare. Penta not only easily finds its place in the home but also perfectly adapts to the environment of a hotel or to any type of project within the commercial sector.*

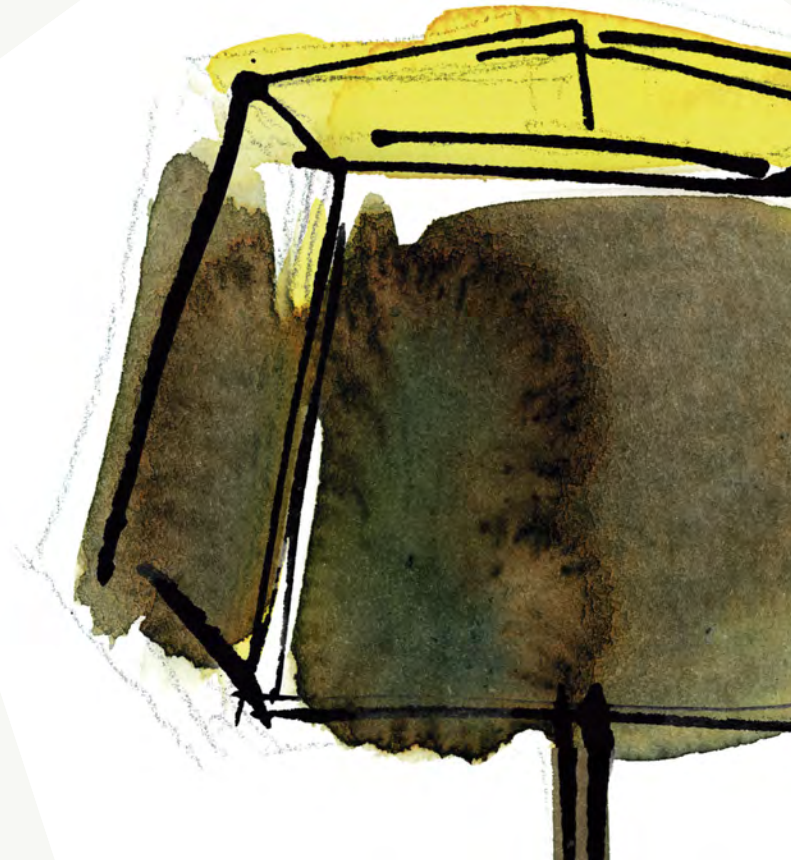
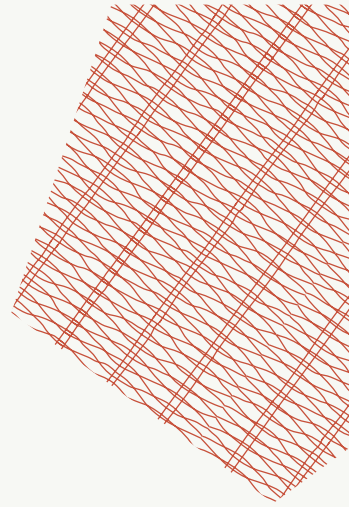

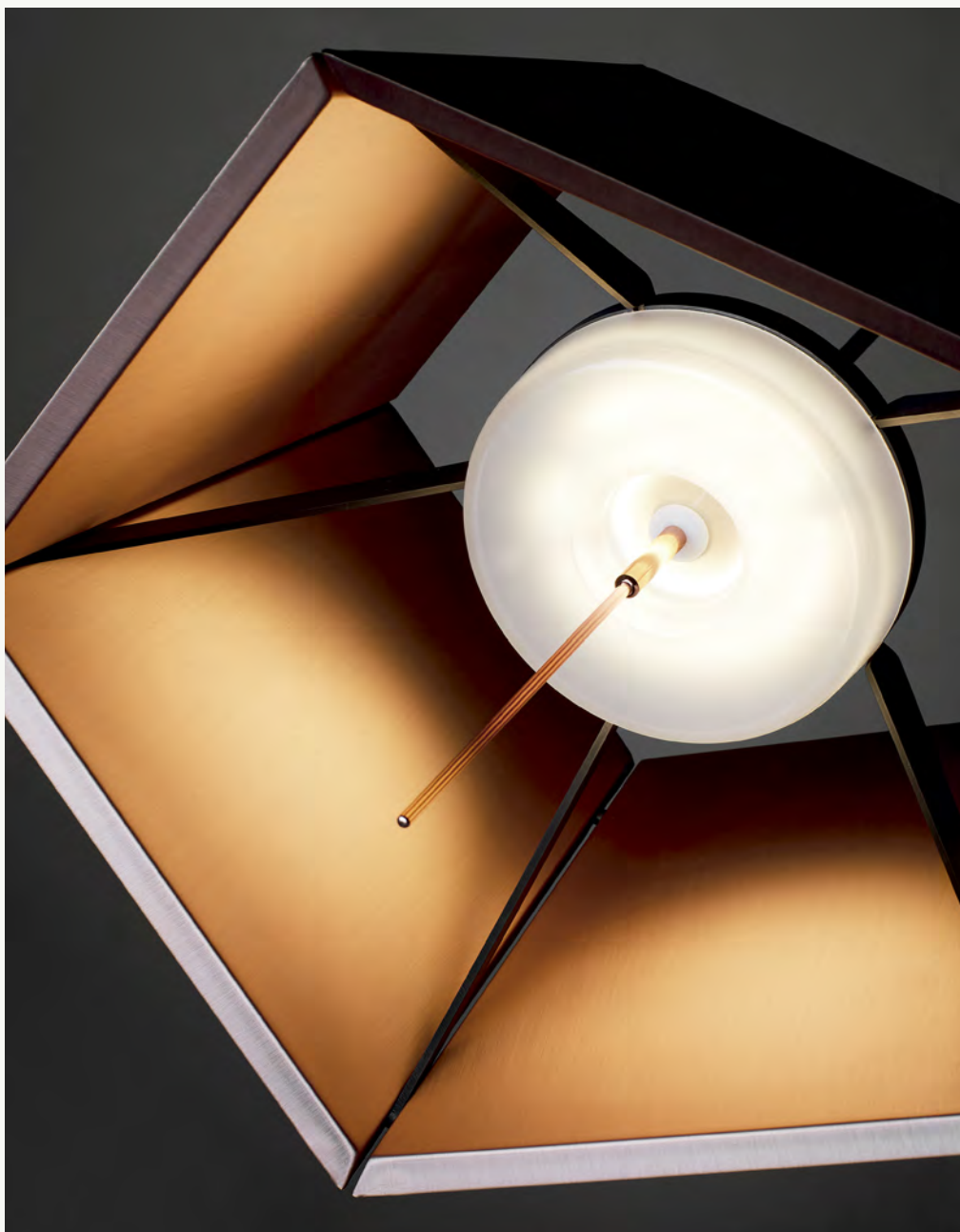







## Penta S

Suspensión / Pendant Lamp



- 3550121883 Exterior Latón Envejecido, Interior Latón Pulido  
*Antique Brass Outside, Polished Brass Inside*
- 3550121884 Exterior Cobre Envejecido, Interior Cobre Pulido  
*Antique Copper Outside, Polished Copper Inside*
- 3550121885 Exterior Aluminio Grafito, Interior Aluminio Pulido  
*Graphite Aluminum Outside, Polished Aluminum Inside*
- 35501218103 Blanco Roto / *Natural White*
- 35501218104 Gris Oliva / *Olive Gray*
- 35501218105 Arena / *Sand*

Interruptor Touch Dimmer / *Touch Dimmer Switch*

### Difusor / *Diffuser*

Metacrilato  
*Methacrylate*

### Materiales / *Materials*

Aluminio, Latón o Hierro, Cable coaxial negro  
*Aluminum, Brass or Iron, Black coaxial cable*

### Acabados / *Finishing*

### Familia / *Family*

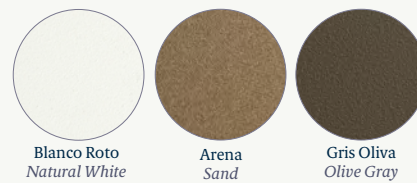
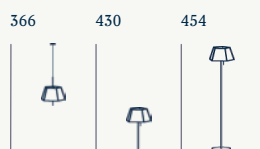

# Siam

by Joana Bover | 2010





Siam respira un cierto  
aire oriental y nos ofrece  
una luz tenue y matizada.

*Siam breaths a certain  
Asian aesthetic and offers  
a soft cascading light.*









## Siam 4L

Suspensión / Pendant Lamp

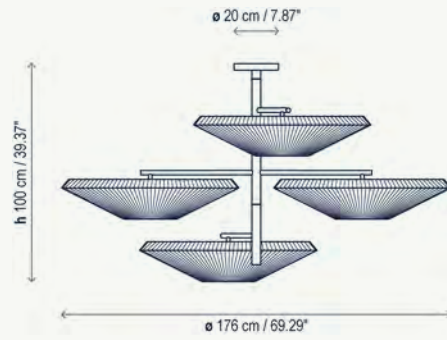

- 4432005/P686C Estructura Níquel Satinado  
Cinta Translúcida Blanca  
*Satin Nickel - White Translucent Ribbon*
- 4432005/P687C Estructura Níquel Satinado  
Cinta Translúcida Crema  
*Satin Nickel - Cream Translucent Ribbon*
- 4432005/P688C Estructura Níquel Satinado  
Cinta Translúcida Roja  
*Satin Nickel - Red Translucent Ribbon*

Pantalla 80 x 18 cm ( x 4 Unidades )  
Lampshade: 31.50" x 7,09" ( x 4 Units )

## Siam 6L

Suspensión / Pendant Lamp

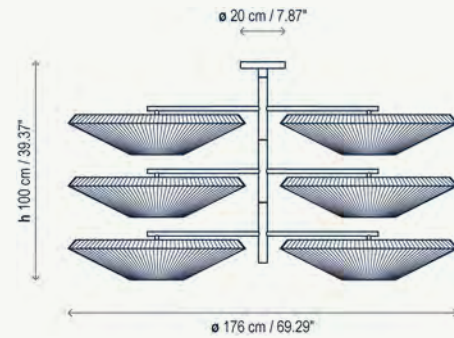

- 4632005/P686C Estructura Níquel Satinado  
Cinta Translúcida Blanca  
*Satin Nickel - White Translucent Ribbon*
- 4632005/P687C Estructura Níquel Satinado  
Cinta Translúcida Crema  
*Satin Nickel - Cream Translucent Ribbon*
- 4632005/P688C Estructura Níquel Satinado  
Cinta Translúcida Roja  
*Satin Nickel - Red Translucent Ribbon*

Pantalla 80 x 18 cm ( x 6 Unidades )  
Lampshade: 31.50" x 7,09" ( x 6 Units )

### Materiales / Materials

Hierro  
*Iron*

### Difusor / Diffuser

PVC 500  
*PVC 500*

### Familia / Family

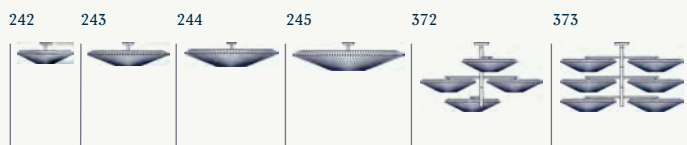

### Acabados / Finishing



# Slend

by Christophe Mathieu | 2014



INTERIOR  
DESIGN  
**BEST  
OF**  
YEAR HONOREE  
2014





Slend viste el espacio con distintas formas esbeltas y sutiles, que nos permitan realizar gran variedad de combinaciones. La luz directa con una apertura de 100° hace de Slend una elección excelente para espacios y objetos que queremos resaltar (mesas de restaurante, mostradores de tiendas, huecos de escalera, etc.)

*Slend dresses the space with different slender and subtle forms which allow us to make a great variety of combinations. Its direct light with a 100° opening makes Slend an excellent choice for spaces and objects that we want to highlight (restaurant tables, shop counters, stairwells, etc.)*





*Restaurant Estilo Tango / Cardedeu*

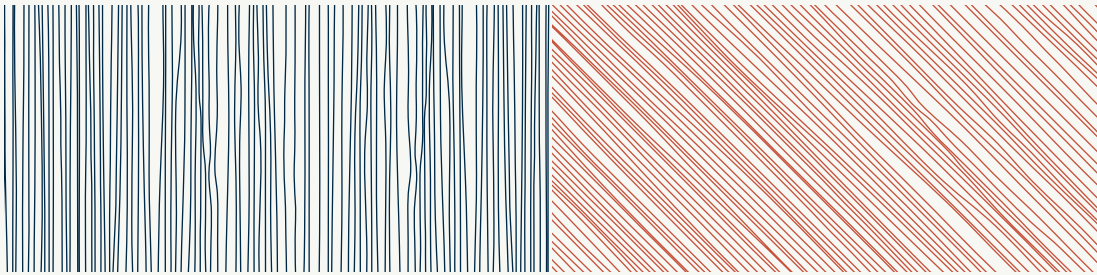



Acabado mate disponible (consultar) / Matte finish available (please consult)

## Slend 01

Suspensión / Pendant Lamp

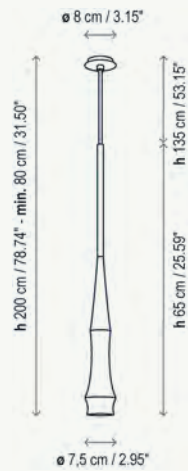

2560120064 Aluminio Pulido - Florón Cromo  
Cable Transparente  
*Polished Aluminum - Chrome Canopy  
Transparent Cable*

2560120001 Blanco Brillo - Florón Blanco - Cable Blanco  
*Brilliant White - White Canopy - White Cable*

2560120023 Negro Brillo - Florón Negro - Cable Negro  
*Brilliant Black - Black Canopy - Black Cable*

## Slend 02

Suspensión / Pendant Lamp

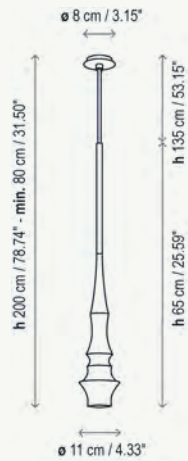

2560220064 Aluminio Pulido - Florón Cromo  
Cable Transparente  
*Polished Aluminum - Chrome Canopy  
Transparent Cable*

2560220001 Blanco Brillo - Florón Blanco - Cable Blanco  
*Brilliant White - White Canopy - White Cable*

2560220023 Negro Brillo - Florón Negro - Cable Negro  
*Brilliant Black - Black Canopy - Black Cable*

## Slend 03

Suspensión / Pendant Lamp

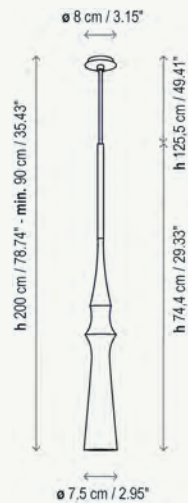

2560320064 Aluminio Pulido - Florón Cromo  
Cable Transparente  
*Polished Aluminum - Chrome Canopy  
Transparent Cable*

2560320001 Blanco Brillo - Florón Blanco - Cable Blanco  
*Brilliant White - White Canopy - White Cable*

2560320023 Negro Brillo - Florón Negro - Cable Negro  
*Brilliant Black - Black Canopy - Black Cable*

## Materiales / Materials

Aluminio  
Aluminum



## Slend Set 3 Circular

Suspensión / Pendant Lamp

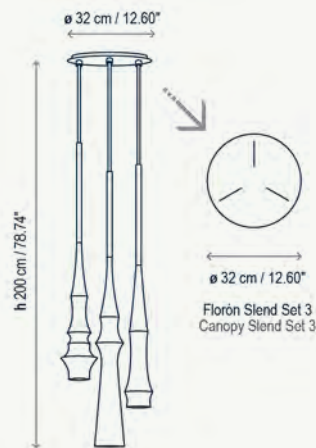

- 2560420064 **Aluminio Pulido - Florón Blanco**  
Cable Transparente  
*Polished Aluminum - White Canopy*  
Transparent Cable
- 2560420001 **Blanco Brillo - Florón Blanco - Cable Blanco**  
*Brilliant White - White Canopy - White Cable*
- 2560420023 **Negro Brillo - Florón Negro - Cable Negro**  
*Brilliant Black - Black Canopy - Black Cable*

## Slend Set 3 Rectangular

Suspensión / Pendant Lamp

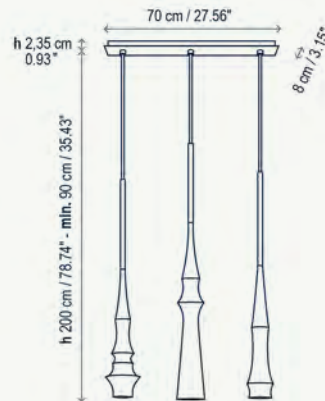

- 2560620064 **Aluminio Pulido - Caja Blanco**  
Cable Transparente  
*Polished Aluminum - White Plate*  
Transparent Cable
- 2560620001 **Blanco Brillo - Caja Blanca - Cable Blanco**  
*Brilliant White - White Plate - White Cable*
- 2560620023 **Negro Brillo - Caja Negra - Cable Negro**  
*Brilliant Black - Black Plate - Black Cable*

## Slend Set 6

Suspensión / Pendant Lamp

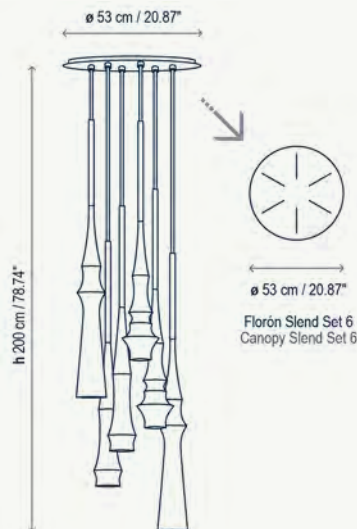

- 2560520064 **Aluminio Pulido - Florón Blanco**  
Cable Transparente  
*Polished Aluminum - White Canopy*  
Transparent Cable
- 2560520001 **Blanco Brillo - Florón Blanco - Cable Blanco**  
*Brilliant White - White Canopy - White Cable*
- 2560520023 **Negro Brillo - Florón Negro - Cable Negro**  
*Brilliant Black - Black Canopy - Black Cable*

Altura regulable / Adjustable height  
Incluye dos modelos de cada luminaria (Slend 01, 02, 03)  
Includes two fittings of each (Slend 01, 02, 03)

### Acabados / Finishing



# Syra 45

by Alex Fernández Camps / Gonzalo Milà | 2014



Las Syra son productos ideales para terrazas y porches cubiertos que necesiten luz cálida y elementos amables que ofrezcan buenas dosis de confort. Estas prestaciones se consiguen gracias a la fibra sintética utilizada para la confección artesanal de su gran pantalla.

*Syra are ideal products for covered terraces and porches that need warm light and gentle elements that offer good comfort. These features are achieved thanks to the synthetic fiber used for the shade's craftwork.*





# Syra 45 Indoor

Suspensión / Pendant Lamp

|  |  |              |
|--|--|--------------|
|  |  | 230V<br>50Hz |
|  |  |              |
| 17 W LED / 54 x 0.33 W = 17 W<br>2050 lm / CRI: 90 / 2700° K |  |              |

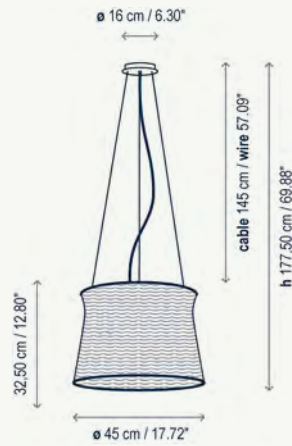

- 26401201100 Estructura Blanco Roto - Pantalla Blanco Marfil  
*Structure Natural White - Ivory White Shade*
- 26401201101 Estructura Marrón Grafito - Pantalla Marrón  
*Structure Graphite Brown - Brown Shade*
- \*26401209100 Regulable Sistema DALI  
Estructura Blanco Roto - Pantalla Blanco Marfil  
*DALI Dimming System  
Structure Natural White - Ivory White Shade*
- \*26401209101 Regulable Sistema DALI  
Estructura Marrón Grafito - Pantalla Marrón  
*DALI Dimming System  
Structure Graphite Brown - Brown Shade*

## Difusor / Diffuser

Cristal Soplado Opal  
*Opal Blown Crystal*

## Familia / Family



## Materiales / Materials

Aluminio - Hierro - Fibra sintética  
*Aluminum - Iron - Synthetic fiber*

## Acabados / Finishing

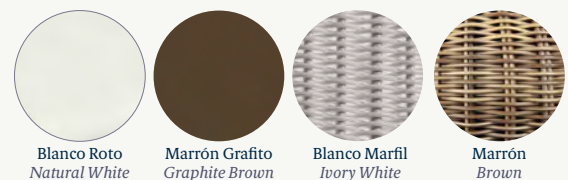

# Tibeta

by Christophe Mathieu | 2015



Tibeta es una familia de luminarias de suspensión realizadas a partir de un cuerpo de aluminio torneado. Está formada por tres volúmenes de distintas dimensiones y formas, que pueden utilizarse individualmente o en conjuntos de tres o más, según las necesidades del usuario.

*Tibeta is a family of pendant lights made off a spun aluminum body available in three different sizes and shapes which can be used either individually or in groups of three or more units according to client's needs.*









*EleRoom62, Casa Decor Madrid 2016*





## Tibeta 01

Suspensión / Pendant Lamp

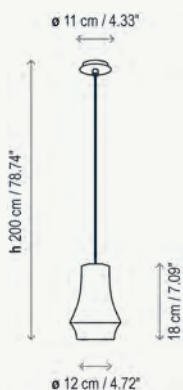

- 2570120107 Cromo Negro - Cable Textil Negro  
*Black Chrome - Black Fabric Cable*
- 2570120190 Cobre Brillo - Cable Metálico Color Cobre  
*Brilliant Copper - Copper Metal Mesh*
- 2570120179 Latón Envejecido - Cable Textil Negro  
*Antique Brass - Black Fabric Cable*

Sistema de regulación TRIAC / TRIAC dimming system

## Tibeta 02

Suspensión / Pendant Lamp

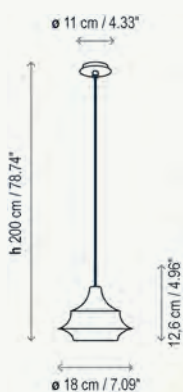

- 2570220107 Cromo Negro - Cable Textil Negro  
*Black Chrome - Black Fabric Cable*
- 2570220190 Cobre Brillo - Cable Metálico Color Cobre  
*Brilliant Copper - Copper Metal Mesh*
- 2570220179 Latón Envejecido - Cable Textil Negro  
*Antique Brass - Black Fabric Cable*

Sistema de regulación TRIAC / TRIAC dimming system

## Tibeta 03

Suspensión / Pendant Lamp

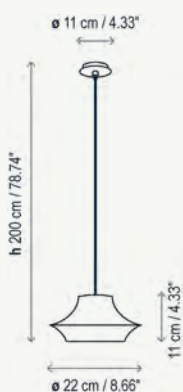

- 2570320107 Cromo Negro - Cable Textil Negro  
*Black Chrome - Black Fabric Cable*
- 2570320190 Cobre Brillo - Cable Metálico Color Cobre  
*Brilliant Copper - Copper Metal Mesh*
- 2570320179 Latón Envejecido - Cable Textil Negro  
*Antique Brass - Black Fabric Cable*

Sistema de regulación TRIAC / TRIAC dimming system

## Tibeta Set 3

Suspensión / Pendant Lamp

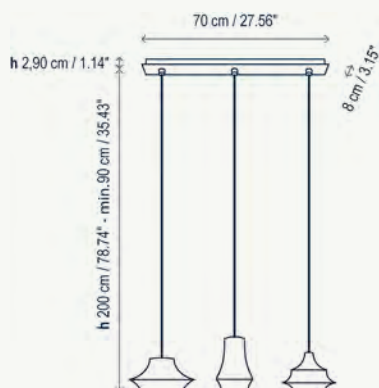

- 2570420107 Cromo Negro - Cable Textil Negro - Florón Negro  
*Black Chrome - Black Fabric Cable - Black Canopy*
- 2570420190 Cobre Brillo - Cable Metálico Color Cobre  
 Florón Blanco  
*Brilliant Copper - Copper Metal Mesh  
 White Canopy*
- 2570420179 Latón Envejecido - Cable Textil Negro  
 Florón Negro  
*Antique Brass - Black Fabric Cable - Black Canopy*

Sistema de regulación TRIAC / *TRIAC dimming system*



### Materiales / Materials

Aluminio  
 Aluminum

### Acabados / Finishing

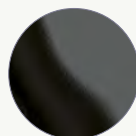

Cromo Negro  
 Black Chrome

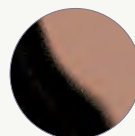

Cobre Brillante  
 Brilliant Copper

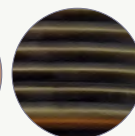

Latón Envejecido  
 Antique Brass

# Urban

by Joana Bover | 2011



La colección Urban ofrece luz de ambiente a través de la pantalla de cinta hecha a mano y del difusor de metacrilato tanto superior como inferior; aportando calidez e intemporalidad tanto a ambientes residenciales como contract.



*The Urban collection offers ambient light through its handmade ribbon shade and the top and bottom methacrylate diffuser; bringing warmth and timelessness to both residential and commercial environments.*

## Urban S/37

Suspensión / Pendant Lamp

- 

230V  
50Hz
- 

- 
2 x 46 W Classic P Eco E-27
- 
2 x 22 W E-27
- 
2 x 6 W LED E-27 P48



- 410132506B Cromo-Cinta Translúcida Blanca  
*Chrome-White Translucent Ribbon*
- 410132506C Cromo-Cinta Translúcida Crema  
*Chrome-Cream Translucent Ribbon*
- 410132506R Cromo-Cinta Translúcida Roja  
*Chrome-Red Translucent Ribbon*

## Urban S/60

Suspensión / Pendant Lamp

- 

230V  
50Hz
- 

- 
4 x 46 W Classic P Eco E-27
- 
4 x 22 W E-27
- 
4 x 6 W LED E-27 P48

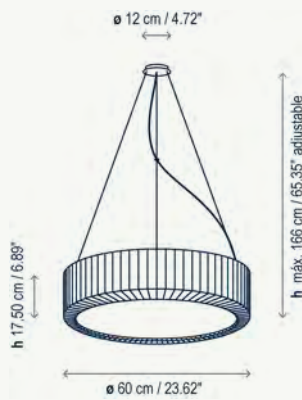

- 410232506B Cromo-Cinta Translúcida Blanca  
*Chrome-White Translucent Ribbon*
- 410232506C Cromo-Cinta Translúcida Crema  
*Chrome-Cream Translucent Ribbon*
- 410232506R Cromo-Cinta Translúcida Roja  
*Chrome-Red Translucent Ribbon*

- 

230V  
50Hz



- 
34 W LED  
2686 lm / CRI: 80 / 2700° K

- 610232506B Dimable TRIAC Cromo  
Cinta Translúcida Blanca  
*Dimmable TRIAC Chrome  
White Translucent Ribbon*
- 610232506C Dimable TRIAC Cromo  
Cinta Translúcida Crema  
*Dimmable TRIAC Chrome  
Cream Translucent Ribbon*
- 610232506R Dimable TRIAC Cromo  
Cinta Translúcida Roja  
*Dimmable TRIAC Chrome  
Red Translucent Ribbon*

## Familia / Family





## Urban S/90

Suspensión / Pendant Lamp

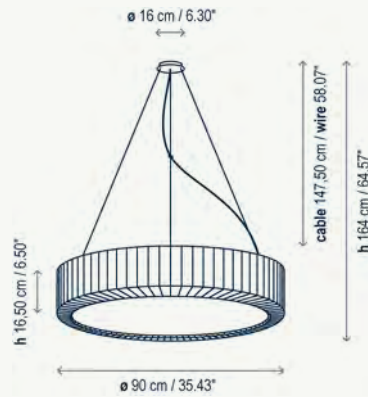

- 410432506B Cromo - Cinta Translúcida Blanca  
*Chrome - White Translucent Ribbon*
- 410432506C Cromo - Cinta Translúcida Crema  
*Chrome - Cream Translucent Ribbon*
- 410432506R Cromo - Cinta Translúcida Roja  
*Chrome - Red Translucent Ribbon*

## Urban S/120

Suspensión / Pendant Lamp

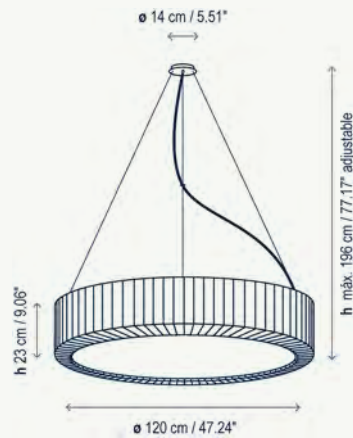

- 410332506B Cromo - Cinta Translúcida Blanca  
*Chrome - White Translucent Ribbon*
- 410332506C Cromo - Cinta Translúcida Crema  
*Chrome - Cream Translucent Ribbon*
- 410332506R Cromo - Cinta Translúcida Roja  
*Chrome - Red Translucent Ribbon*
- \*D410332506B Regulable Sistema DALI  
Cromo - Cinta Translúcida Blanca  
*DALI Dimming System  
Chrome - White Translucent Ribbon*
- \*D410332506C Regulable Sistema DALI  
Cromo - Cinta Translúcida Crema  
*DALI Dimming System  
Chrome - Cream Translucent Ribbon*
- \*D410332506R Regulable Sistema DALI  
Cromo - Cinta Translúcida Roja  
*DALI Dimming System  
Chrome - Red Translucent Ribbon*

### Difusores / Diffusers

Urban S/37 - Urban S/60:  
Superior e inferior: Cristal Óptico  
*Upper & Lower: Optical Glass*

Urban S/120:  
Superior / Upper:  
Policarbonato / Polycarbonate  
Inferior / Lower:  
Metacrilato / Methacrylate

### Materiales / Materials

Hierro  
*Iron*

### Acabados / Finishing

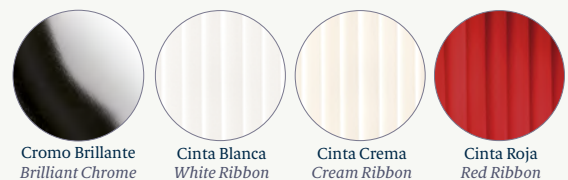

# Danona

by Joana Bover | 2002



Danona es un claro ejemplo de un producto contemporáneo e intemporal que se adapta a cualquier ambiente o aplicación. Tanto la piel como las pantallas le aportan calidez.

*Danona is a good example of contemporaneous and timeless product adaptable to any environment. Both leather along with the ribbon shades contribute to its warmth.*

## Danona Mini

Mesa / Table Lamp



1 x 46 W Classic P Eco E-27

1 x 6 W LED E-27 P48

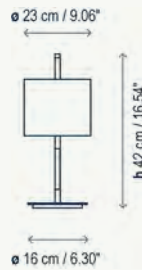

- 2023105/P230 Níquel Satinado - Cotonet  
*Satin Nickel - Cotton*
- 2023105/P003 Níquel Satinado - Cinta Translúcida Crema  
*Satin Nickel - Cream Translucent Ribbon*
- 2023105/P004 Níquel Satinado - Cinta Translúcida Blanca  
*Satin Nickel - White Translucent Ribbon*
- 2023160/P230 Níquel Piel Oscura - Cotonet  
*Nickel Dark Brown Leather - Cotton*
- 2023160/P003 Níquel Piel Oscura  
Cinta Translúcida Crema  
*Nickel Dark Brown Leather  
Cream Translucent Ribbon*
- 2023160/P004 Níquel Piel Oscura  
Cinta Translúcida Blanca  
*Nickel Dark Brown Leather  
White Translucent Ribbon*

Pantalla 23 x 17 x 23 cm / Lampshade 9.06" x 6.69" x 9.06"

## Danona T

Mesa / Table Lamp



1 x 46 W Classic P Eco E-27

1 x 11 W E-27

1 x 6 W LED E-27 P48

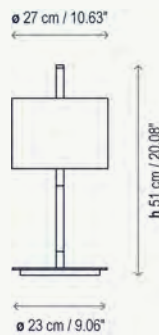

- 2123105/P227 Níquel Satinado - Cotonet  
*Satin Nickel - Cotton*
- 2123105/P005 Níquel Satinado - Cinta Translúcida Crema  
*Satin Nickel - Cream Translucent Ribbon*
- 2123105/P006 Níquel Satinado - Cinta Translúcida Blanca  
*Satin Nickel - White Translucent Ribbon*
- 2123160/P227 Níquel Piel Oscura - Cotonet  
*Nickel Dark Brown Leather - Cotton*
- 2123160/P005 Níquel Piel Oscura  
Cinta Translúcida Crema  
*Nickel Dark Brown Leather  
Cream Translucent Ribbon*
- 2123160/P006 Níquel Piel Oscura  
Cinta Translúcida Blanca  
*Nickel Dark Brown Leather  
White Translucent Ribbon*

Pantalla 27 x 18 x 27 cm / Lampshade 10.63" x 7.09" x 10.63"

### Difusor / Diffuser

Metacrilato / Methacrylate

### Materiales / Materials

Hierro - Piel  
*Iron - Leather*

### Familia / Family

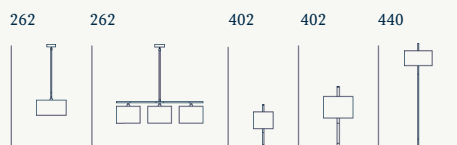

### Acabados / Finishing



# Drip/Drop

by Christophe Mathieu | 2017



Todos los modelos de Drip & Drop prestan especial atención al detalle, a la calidad de la luz, sus brillos, colores y contrastes, pero sobre todo a la necesidad específica que han de cubrir:

*All Drip & Drop models pay special attention to detail, to the quality of light, its brightness, color and contrast but especially to the specific needs they meet.*











## Drip M/35

Mesa / Table Lamp



3 W LED  
345 lm / CRI: 90 / 2700° K



Interruptor en el cable / Through cord switch



Interruptor Proxy Dimmer / Proxy Dimmer Switch

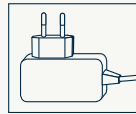

- 2590130338 Ébano Negro - Vidrio Transparente  
Interruptor en el cable  
*Black Ebony - Transparent Glass  
Through Cord Switch*
- 2590130339 Ébano Negro - Vidrio Matizado  
Interruptor en el cable  
*Black Ebony - Frosted Glass  
Through Cord Switch*
- 2590130381 Ébano Negro - Vidrio Verde  
Interruptor en el cable  
*Black Ebony - Green Glass  
Through Cord Switch*
- 2590130386 Ébano Negro - Vidrio Azul  
Interruptor en el cable  
*Black Ebony - Blue Glass  
Through Cord Switch*
- 2590131238 Ébano Negro - Vidrio Transparente  
Interruptor Proxy Dimmer  
*Black Ebony - Transparent Glass  
Proxy Dimmer Switch*
- 2590131239 Ébano Negro - Vidrio Matizado  
Interruptor Proxy Dimmer  
*Black Ebony - Frosted Glass  
Proxy Dimmer Switch*
- 2590131281 Ébano Negro - Vidrio Verde  
Interruptor Proxy Dimmer  
*Black Ebony - Green Glass  
Proxy Dimmer Switch*
- 2590131286 Ébano Negro - Vidrio Azul  
Interruptor Proxy Dimmer  
*Black Ebony - Blue Glass  
Proxy Dimmer Switch*

Cable negro / Black cable

## Drip M/35

Mesa / Table Lamp



3 W LED  
345 lm / CRI: 90 / 2700° K



Interruptor en el cable / Through cord switch



Interruptor Proxy Dimmer / Proxy Dimmer Switch

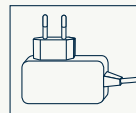

- 2590130356 Ébano Negro - Vidrio Transparente  
Interruptor en el cable  
*Black Ebony - Transparent Glass  
Through Cord Switch*
- 2590130357 Ébano Negro - Vidrio Matizado  
Interruptor en el cable  
*Black Ebony - Frosted Glass  
Through Cord Switch*
- 2590130358 Ébano Negro - Vidrio Verde  
Interruptor en el cable  
*Black Ebony - Green Glass  
Through Cord Switch*
- 2590130359 Ébano Negro - Vidrio Azul  
Interruptor en el cable  
*Black Ebony - Blue Glass  
Through Cord Switch*
- 2590131256 Ébano Negro - Vidrio Transparente  
Interruptor Proxy Dimmer  
*Black Ebony - Transparent Glass  
Proxy Dimmer Switch*
- 2590131257 Ébano Negro - Vidrio Matizado  
Interruptor Proxy Dimmer  
*Black Ebony - Frosted Glass  
Proxy Dimmer Switch*
- 2590131258 Ébano Negro - Vidrio Verde  
Interruptor Proxy Dimmer  
*Black Ebony - Green Glass  
Proxy Dimmer Switch*
- 2590131259 Ébano Negro - Vidrio Azul  
Interruptor Proxy Dimmer  
*Black Ebony - Blue Glass  
Proxy Dimmer Switch*

Cable negro / Black cable

## Drip M/50

Mesa / Table Lamp



3 W LED  
345 lm / CRI: 90 / 2700° K



Interruptor en el cable / Through cord switch



Interruptor Proxy Dimmer / Proxy Dimmer Switch

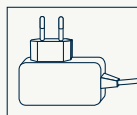

- 2590230338 Ébano Negro - Vidrio Transparente  
Interruptor en el cable  
*Black Ebony - Transparent Glass  
Through Cord Switch*
  - 2590230339 Ébano Negro - Vidrio Matizado  
Interruptor en el cable  
*Black Ebony - Frosted Glass  
Through Cord Switch*
  - 2590230381 Ébano Negro - Vidrio Verde  
Interruptor en el cable  
*Black Ebony - Green Glass  
Through Cord Switch*
  - 2590230386 Ébano Negro - Vidrio Azul  
Interruptor en el cable  
*Black Ebony - Blue Glass  
Through Cord Switch*
- 
- 2590231238 Ébano Negro - Vidrio Transparente  
Interruptor Proxy Dimmer  
*Black Ebony - Transparent Glass  
Proxy Dimmer Switch*
  - 2590231239 Ébano Negro - Vidrio Matizado  
Interruptor Proxy Dimmer  
*Black Ebony - Frosted Glass  
Proxy Dimmer Switch*
  - 2590231281 Ébano Negro - Vidrio Verde  
Interruptor Proxy Dimmer  
*Black Ebony - Green Glass  
Proxy Dimmer Switch*
  - 2590231286 Ébano Negro - Vidrio Azul  
Interruptor Proxy Dimmer  
*Black Ebony - Blue Glass  
Proxy Dimmer Switch*

Cable negro / Black cable

## Drop M/50

Mesa / Table Lamp



3 W LED  
345 lm / CRI: 90 / 2700° K

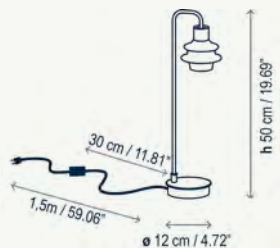

Interruptor en el cable / Through cord switch

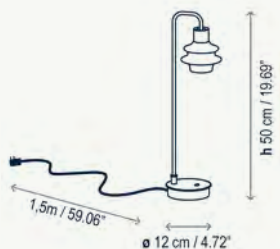

Interruptor Proxy Dimmer / Proxy Dimmer Switch

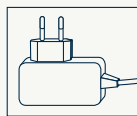

- 2590230356 Ébano Negro - Vidrio Transparente  
Interruptor en el cable  
*Black Ebony - Transparent Glass  
Through Cord Switch*
  - 2590230357 Ébano Negro - Vidrio Matizado  
Interruptor en el cable  
*Black Ebony - Frosted Glass  
Through Cord Switch*
  - 2590230358 Ébano Negro - Vidrio Verde  
Interruptor en el cable  
*Black Ebony - Green Glass  
Through Cord Switch*
  - 2590230359 Ébano Negro - Vidrio Azul  
Interruptor en el cable  
*Black Ebony - Blue Glass  
Through Cord Switch*
- 
- 2590231256 Ébano Negro - Vidrio Transparente  
Interruptor Proxy Dimmer  
*Black Ebony - Transparent Glass  
Proxy Dimmer Switch*
  - 2590231257 Ébano Negro - Vidrio Matizado  
Interruptor Proxy Dimmer  
*Black Ebony - Frosted Glass  
Proxy Dimmer Switch*
  - 2590231258 Ébano Negro - Vidrio Verde  
Interruptor Proxy Dimmer  
*Black Ebony - Green Glass  
Proxy Dimmer Switch*
  - 2590231259 Ébano Negro - Vidrio Azul  
Interruptor Proxy Dimmer  
*Black Ebony - Blue Glass  
Proxy Dimmer Switch*

Cable negro / Black cable

## Drop M/70

Mesa / Table Lamp

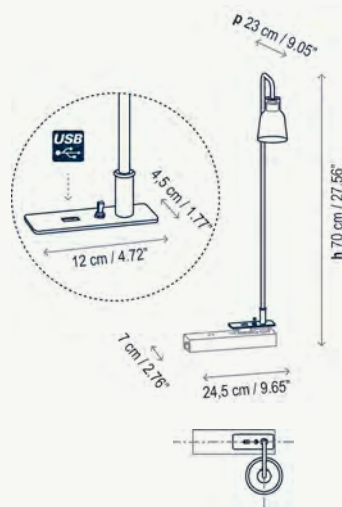

- 2590331338 Ébano Negro - Vidrio Transparente  
Black Ebony - Transparent Glass
- 2590331339 Ébano Negro - Vidrio Matizado  
Black Ebony - Frosted Glass
- 2590331381 Ébano Negro - Vidrio Verde  
Black Ebony - Green Glass
- 2590331386 Ébano Negro - Vidrio Azul  
Black Ebony - Blue Glass

Brazo fijo / Fixed arm  
Interruptor y entrada conector USB en la base  
Switch and USB port located on the base

## Drop M/70

Mesa / Table Lamp

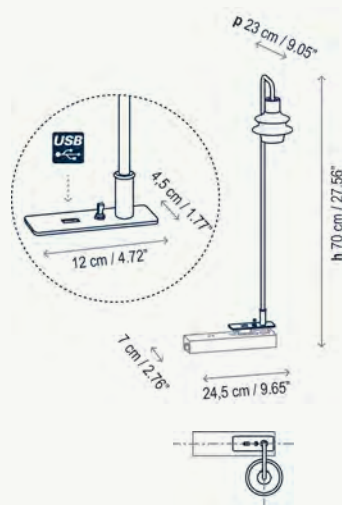

- 2590331356 Ébano Negro - Vidrio Transparente  
Black Ebony - Transparent Glass
- 2590331357 Ébano Negro - Vidrio Matizado  
Black Ebony - Frosted Glass
- 2590331358 Ébano Negro - Vidrio Verde  
Black Ebony - Green Glass
- 2590331359 Ébano Negro - Vidrio Azul  
Black Ebony - Blue Glass

Brazo fijo / Fixed arm  
Interruptor y entrada conector USB en la base  
Switch and USB port located on the base

### Acabados Drip / Finishing Drip



Vidrio Transparente / Transparent Glass  
Vidrio Matizado / Frosted Glass  
Vidrio Verde / Green Glass  
Vidrio Azul / Blue Glass

### Acabados Drop / Finishing Drop



Vidrio Transparente / Transparent Glass  
Vidrio Matizado / Frosted Glass  
Vidrio Verde / Green Glass  
Vidrio Azul / Blue Glass

### Familia / Family



### Materiales / Materials

Hierro - Vidrio borosilicato  
Iron - Borosilicate glass

# Ema

by Joana Bover | 2004



## Ema T

Mesa / Table Lamp

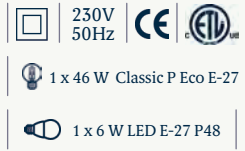

- 2119405/P479 Níquel Satinado - Cotonet  
*Satin Nickel - Cotton*
- 2119405/P478 Níquel Satinado - Lino  
*Satin Nickel - Linen*
- 2119460/P479 Níquel Piel Oscura - Cotonet  
*Nickel Dark Brown Leather - Cotton*
- 2119460/P478 Níquel Piel Oscura - Lino  
*Nickel Dark Brown Leather - Linen*

Pantalla rectangular 33 x 23 x 21 cm  
*Rectangular lampshade 12.99" x 9.05" x 8.27"*

Ema es una pieza clásica y formal. El cuerpo simétrico de níquel combinado con piel y la pantalla textil; se equilibran en Ema para ofrecer una luz indirecta, suave y confortable.

*Ema is a classic and formal piece. The symmetrical nickel body combined with leather and a textile shade is balanced to provide indirect, soft and comfortable light.*

### Familia / Family

412 446



### Materiales / Materials

Latón - Acero inoxidable 304 - Piel  
*Brass - 304 Stainless steel - Leather*

### Acabados / Finishing



# Garota

by Alex Fernández Camps / Gonzalo Milà | 2015



Garota, inspirada en el caparazón de un erizo de mar, nos ofrece una luz cálida y tamizada; envuelta en formas orgánicas, redondeadas y sutiles; pensada para acompañarnos en zonas de interior y exterior indistintamente.

*Garota, inspired by a sea urchin's shell, offers us a warm and dispersed light; wrapped in organic, rounded and subtle forms; designed to indistinctly accompany us in interior and exterior areas.*

## Garota M/01

Mesa / Table Lamp



1 x 46 W Classic P Eco E-27

1 x 4 W LED E-27 P48



3350630001/P803 Blanco Roto - Pantalla Blanco Marfil  
Natural White - Ivory White Shade

3350630001/P804 Blanco Roto - Pantalla Marrón  
Natural White - Brown Shade

3350630003/P804 Marrón Grafito - Pantalla Marrón  
Brown White - Brown Shade

3350630003/P803 Marrón Grafito - Pantalla Blanco Marfil  
Brown White - Ivory White Shade

No incluye globo elipse / Globe not included  
Cable e interruptor transparentes / Transparent cable PVC and switch

## Garota M/02

Mesa / Table Lamp



1 x 9 W LED / 9 W  
960 lm / CRI: 90 / 2700° K



3350630301/P803 Blanco Roto - Pantalla Blanco Marfil  
Natural White - Ivory White Shade

3350630303/P804 Marrón Grafito - Pantalla Marrón  
Brown White - Brown Shade

Incluye globo elipse / Globe included  
Cable e interruptor transparentes / Transparent cable PVC and switch

### Familia Interior / Indoor Family

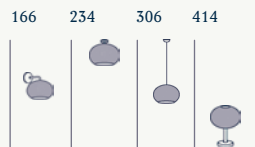

### Familia Exterior / Outdoor Family



### Materiales / Materials

Aluminio - Acero inoxidable - Polietileno - Fibra sintética  
Aluminum - Stainless steel - Polyethylene - Synthetic fiber

Todas las fibras sintéticas utilizadas por Bover son reciclables y no tóxicas para la sostenibilidad del medio ambiente

All synthetic fibers used by Bover are recyclable and non-toxic for environmental sustainability.

### Acabados / Finishing



# Gibsi

by Joana Bover | 2003





Las Gibsi son unas pequeñas lámparas, altas y delgadas. Un halo de luz pensado para acompañar pequeños espacios donde queramos aportar un punto de calidez.

*The Gibsi are small lamps, tall and thin. A halo of light designed to accompany small spaces where we want to provide a point of warmth.*



## Gibsi 01

Mesa / Table Lamp



-  230V 50Hz | CE
-  1 x 33 W G-9 (Halopin Eco)
-  1 x 3,5 W LED G-9



- 2018205/P459 Níquel Satinado - Cinta Translúcida Blanca  
*Satin Nickel - White Translucent Ribbon*
- 2018205/P463 Níquel Satinado - Cinta Translúcida Crema  
*Satin Nickel - Cream Translucent Ribbon*
- 2018205/P465 Níquel Satinado - Cinta Translúcida Roja  
*Satin Nickel - Red Translucent Ribbon*
- 2018205/P464 Níquel Satinado - Cotonet  
*Satin Nickel - Cotton*
- 2018205/P460 Níquel Satinado - Cotonet Negro  
*Satin Nickel - Black Cotton*

## Gibsi 02

Mesa / Table Lamp

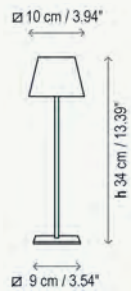

-  230V 50Hz | CE
-  1 x 33 W G-9 (Halopin Eco)
-  1 x 3,5 W LED G-9



- 2118205/P459 Níquel Satinado - Cinta Translúcida Blanca  
*Satin Nickel - White Translucent Ribbon*
- 2118205/P463 Níquel Satinado - Cinta Translúcida Crema  
*Satin Nickel - Cream Translucent Ribbon*
- 2118205/P465 Níquel Satinado - Cinta Translúcida Roja  
*Satin Nickel - Red Translucent Ribbon*
- 2118205/P464 Níquel Satinado - Cotonet  
*Satin Nickel - Cotton*
- 21 18205/P460 Níquel Satinado - Cotonet Negro  
*Satin Nickel - Black Cotton*

## Gibsi 03

Mesa / Table Lamp

-  230V 50Hz | CE
-  1 x 33 W G-9 (Halopin Eco)
-  1 x 3,5 W LED G-9

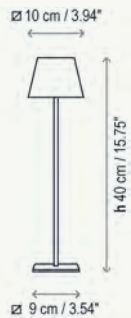

- 2218205/P459 Níquel Satinado - Cinta Translúcida Blanca  
*Satin Nickel - White Translucent Ribbon*
- 2218205/P463 Níquel Satinado - Cinta Translúcida Crema  
*Satin Nickel - Cream Translucent Ribbon*
- 2218205/P465 Níquel Satinado - Cinta Translúcida Roja  
*Satin Nickel - Red Translucent Ribbon*
- 2218205/P464 Níquel Satinado - Cotonet  
*Satin Nickel - Cotton*
- 22 18205/P460 Níquel Satinado - Cotonet Negro  
*Satin Nickel - Black Cotton*

Pantalla 10 x 9 x 7 cm / Lampshade 3.94" x 3.54" x 2.76"

(\*) Aconsejamos un uso máximo ininterrumpido de 4/5 horas debido al tamaño de las pantallas.  
*It is not recommended longer non-stop use of 4/5 hours due to the shade's measures.*



### Materiales / Materials

Hierro  
*Iron*

### Acabados / Finishing

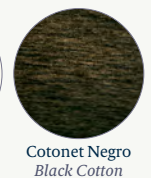
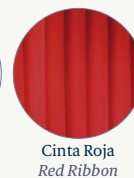

# Inari

by Joana Bover | 2010



## Inari T

Mesa / Table Lamp



3 x 46 W Classic P Eco E-27

3 x 18 W E-27 Dulux Intelligent dimmable

3 x 6 W LED E-27 P48

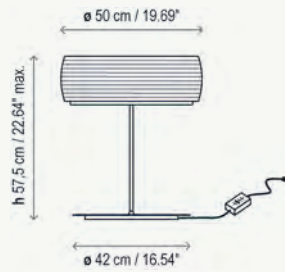

2220205 Níquel-Cristal Opal Grabado  
*Nickel-Opal Glass*

2220206 Cromo-Cristal Opal Grabado  
*Chrome-Opal Glass*

Lámpara con interruptor dimmer apto para los portalámparas E-27 recomendados / Light with built in switch dimmer for recommended E-27 lamp holder

Inari es una colección de lámparas de cristal soplado opal. Su característica principal reside en el grabado de sus líneas irregulares que dan forma y carácter al producto. Inari es una luminaria que emite una luz clara y envolvente que le confiere un alto grado de confort.

*Inari is a collection of opal blown glass lamps, having its main feature on the irregularity of its lines which confer form and character to the product. Inari emits a soft, cozy and diffused light with a great degree of comfort.*

### Familia / Family

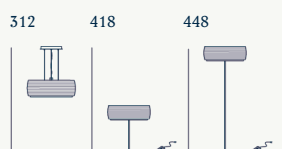

### Difusor / Diffuser

Cristal Óptico  
*Optic Glass*

### Materiales / Materials

Hierro - Cristal soplado  
*Iron - Blown glass*

### Acabados / Finishing

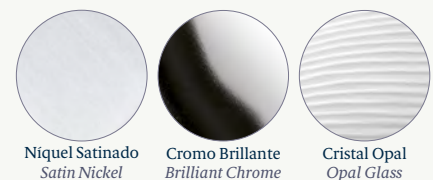

Níquel Satinado  
*Satin Nickel*

Cromo Brillante  
*Brilliant Chrome*

Cristal Opal  
*Opal Glass*

# Muf

by Joana Bover | 2007



*Hotel Villa Emilia / Barcelona*

Con su base iluminada Muf sorprende allí a donde se coloque. En función del material que elijamos para la pantalla obtendremos mayor o menor rendimiento lumínico, pero en todos los casos, la lámpara mantendrá una belleza rotunda y una buena tamización de la luz.

*With its illuminated base, Muf surprises wherever it is placed. Depending on the material we choose for the shade, we will get higher or lower light output, but in all cases, the lamp will maintain its unequivocal beauty and fine illumination.*





## Muf 01

Mesa / Table Lamp



1 x 77 W Classic A Eco E-27 + 1 x 20 W Classic P Eco E-14

1 x 9 W LED E-27 A60 + 1 x 6 W LED E-14 P48



2215521/ P561 Cristal Soplado Opal-Cromo  
Cinta Translúcida Blanca  
*Blown Opal Glass-Chrome  
White Translucent Ribbon*

2215521/ P564E/P564  
Cristal Soplado Opal-Cromo - Malla Negra  
*Blown Opal Glass-Chrome - Black Mesh*

2215521/ P565E/P565  
Cristal Soplado Opal-Cromo - Malla Roja  
*Blown Opal Glass-Chrome - Red Mesh*

Pantalla exterior: 27 x 27 x 20 cm  
*Outer lampshade: 10.63" x 10.63" x 7.87"*  
Pantalla Interior: 20 x 26 x 14 cm  
*Inner lampshade: 7.87" x 10.24" x 5.51"*

Lámpara con 3 posiciones de encendido  
*With 3 lighting/mood switch on/off positions*  
Las bombillas de la base están incluidas  
*The base bulbs are included*

## Muf 02

Mesa / Table Lamp



1 x 77 W Classic A Eco E-27 + 2 x 20 W Classic P Eco E-14

1 x 9 W LED E-27 A60 + 2 x 6 W LED E-14 P48

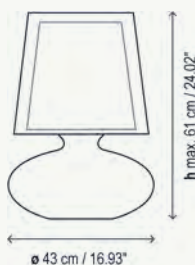

2215522/ P580 Cristal Soplado Opal-Cromo  
Cinta Translúcida Blanca  
*Blown Opal Glass-Chrome  
White Translucent Ribbon*

2215522/ P570E/P570  
Cristal Soplado Opal-Cromo - Malla Negra  
*Blown Opal Glass-Chrome - Black Mesh*

2215522/ P571E/P571  
Cristal Soplado Opal-Cromo - Malla Roja  
*Blown Opal Glass-Chrome - Red Mesh*

Pantalla exterior: 40 x 36 x 31 cm  
*Outer lampshade: 15.75" x 14.17" x 12.20"*  
Pantalla Interior: 30 x 30 x 25 cm  
*Inner lampshade: 11.81" x 11.81" x 9.06"*

Lámpara con 3 posiciones de encendido  
*With 3 lighting/mood switch on/off positions*  
Las bombillas de la base están incluidas  
*The base bulbs are included*

### Materiales / Materials

Cristal soplado opal  
*Opal blown glass*

### Acabados / Finishing



Cinta Blanca  
*White Ribbon*

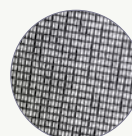

Malla Negra  
*Black Mesh*

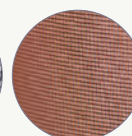

Malla Roja  
*Red Mesh*

# Nón Lá

by Jorge Pensi Design Studio | 2015





# Nón Lá T

Mesa / Table Lamp

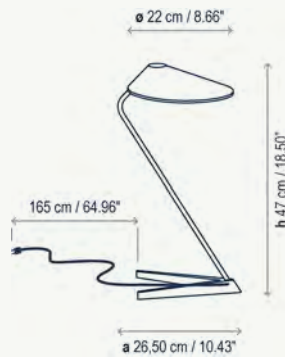

- 3320130301 Blanco Lacado Brillante / *White Brilliant Lacquer*
- 3320130306 Cromo / *Chrome*
- 3320130390 Cobre Brillante / *Brilliant Copper*

Proxy dimmer interruptor / *Proxy dimmer switch*

El brazo y la base son de color negro grafito. La pantalla varía según el acabado elegido (Blanco, Cromo, Cobre)  
*Arm and base in Black Graphite. Shade finished in Chrome, Copper and White Lacquer.*

Driver Connector

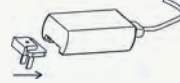

Nón Lá es nuestra manera de rendirle un pequeño homenaje al sombrero vietnamita y a su cultura centenaria. Su sencillo cono abierto, nos ofrece una estructura ligera, resistente y un punto vanguardista gracias a la descentralidad de su cavidad lumínica. Su base de fundición de hierro en forma de ángulo nos ofrece un aspecto más rudo que contrasta con la sutileza de su pantalla cónica.

*Non La is our way of paying a little homage to the Vietnamese hat and its centenary culture. Its simple open cone offers us a light structure that is resistant and a bit avant-garde, thanks to the decentralization of its light cavity. Its cast iron arm in the shape of an angle gives it a rough look that contrasts with the subtlety of its conical shade.*

## Familia / Family

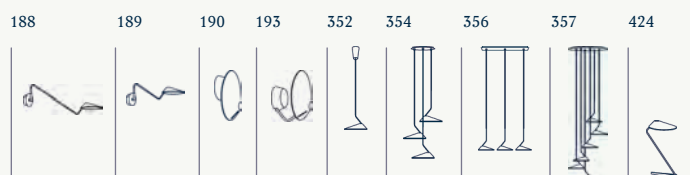

## Materiales / Materials

Aluminio - Hierro fundido  
*Aluminum - Molten Iron*

## Difusor / Diffuser

Metacrilato  
*Methacrylate*

## Acabados / Finishing



# Oval

by Joana Bover | 2006





La colección Oval se completa con las versiones de pared, sobremesa y pie que incorporan a la base metálica detalles de vidrio aportando sofisticación.

*The Oval collection is complete with wall, table and floor versions that incorporate glass adding sophistication to the metal base.*



## Oval M/44

Mesa / Table Lamp



1 x 46 W Classic P Eco E-27

1 x 6 W LED E-27 P48

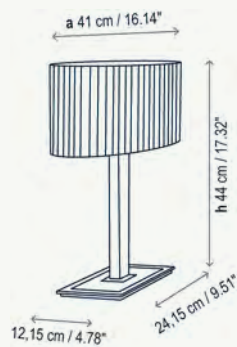

- 2125023/P551D Cromo Cristal Negro - Cinta Translúcida Blanca  
*Chrome Black Glass - White Translucent Ribbon*
- 2125023/P552D Cromo Cristal Negro - Cinta Translúcida Crema  
*Chrome Black Glass - Cream Translucent Ribbon*
- 2125023/P553D Cromo Cristal Negro - Cinta Translúcida Negra  
*Chrome Black Glass - Black Translucent Ribbon*
- 2125023/P554D Cromo Cristal Negro - Cotonet Blanco  
*Chrome Black Glass - White Cotton*
- 2125017/P551D Níquel Cristal Negro - Cinta Translúcida Blanca  
*Nickel Black Glass - White Translucent Ribbon*
- 2125017/P552D Níquel Cristal Negro - Cinta Translúcida Crema  
*Nickel Black Glass - Cream Translucent Ribbon*
- 2125017/P553D Níquel Cristal Negro - Cinta Translúcida Negra  
*Nickel Black Glass - Black Translucent Ribbon*
- 2125017/P554D Níquel Cristal Negro - Cotonet Blanco  
*Nickel Black Glass - White Cotton*

Pantalla oval 41 x 17,5 x 15 cm  
*Oval lampshade 16.14" x 6.89" x 5.91"*

## Oval M/47

Mesa / Table Lamp



1 x 46 W Classic P Eco E-27

1 x 6 W LED E-27 P48

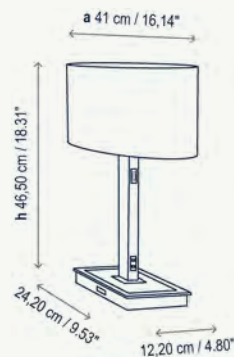

- 2125023USB/P551D Cromo Cristal Negro - Cinta Translúcida Blanca  
*Chrome Black Glass - White Translucent Ribbon*
- 2125023USB/P552D Cromo Cristal Negro - Cinta Translúcida Crema  
*Chrome Black Glass - Cream Translucent Ribbon*
- 2125023USB/P553D Cromo Cristal Negro - Cinta Translúcida Negra  
*Chrome Black Glass - Black Translucent Ribbon*
- 2125023USB/P554D Cromo Cristal Negro - Cotonet Blanco  
*Chrome Black Glass - White Cotton*
- 2125017USB/P551D Níquel Cristal Negro - Cinta Translúcida Blanca  
*Nickel Black Glass - White Translucent Ribbon*
- 2125017USB/P552D Níquel Cristal Negro - Cinta Translúcida Crema  
*Nickel Black Glass - Cream Translucent Ribbon*
- 2125017USB/P553D Níquel Cristal Negro - Cinta Translúcida Negra  
*Nickel Black Glass - Black Translucent Ribbon*
- 2125017USB/P554D Níquel Cristal Negro - Cotonet Blanco  
*Nickel Black Glass - White Cotton*

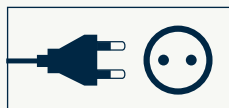

Interruptor de encendido situado en el mástil  
*On/off switch located on the stem*  
Enchufe situado en el mástil para clavija tipo C  
*Switch located on the stem for plug type C*  
Entrada conector USB en la base / *USB port located on the base*

## Familia / Family



## Difusor / Diffuser

Superior: Cristal Negro  
*Upper: Black Glass*

## Oval M/57

Mesa / Table Lamp

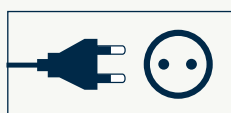
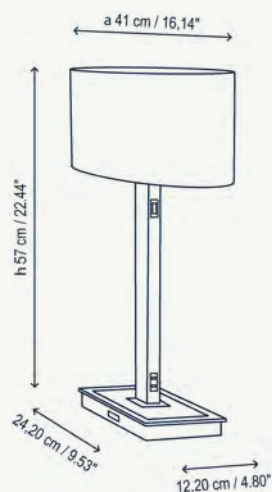

- 4125023USB/P805D Cromo Cristal Negro - Cinta Translúcida Blanca  
*Chrome Black Glass - White Translucent Ribbon*
- 4125023USB/P806D Cromo Cristal Negro - Cinta Translúcida Crema  
*Chrome Black Glass - Cream Translucent Ribbon*
- 4125023USB/P807D Cromo Cristal Negro - Cinta Translúcida Negra  
*Chrome Black Glass - Black Translucent Ribbon*
- 4125023USB/P808D Cromo Cristal Negro - Cotonet Blanco  
*Chrome Black Glass - White Cotton*
- 4125017USB/P805D Níquel Cristal Negro - Cinta Translúcida Blanca  
*Nickel Black Glass - White Translucent Ribbon*
- 4125017USB/P806D Níquel Cristal Negro - Cinta Translúcida Crema  
*Nickel Black Glass - Cream Translucent Ribbon*
- 4125017USB/P807D Níquel Cristal Negro - Cinta Translúcida Negra  
*Nickel Black Glass - Black Translucent Ribbon*
- 4125017U SB/P808D Níquel Cristal Negro - Cotonet Blanco  
*Nickel Black Glass - White Cotton*

Interruptor de encendido situado en el mástil / *On/off switch located on the stem*

Enchufe situado en el mástil para clavija tipo C

*Switch located on the stem for plug type C*

Entrada conector USB en la base / *USB port located on the base*

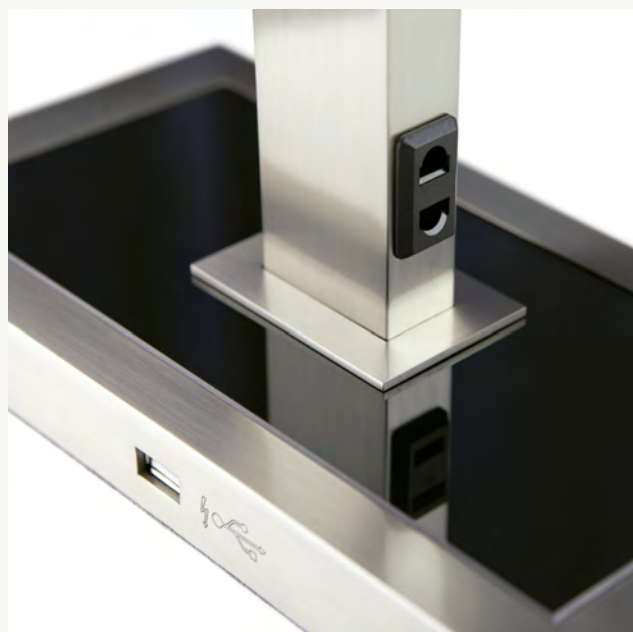

### Materiales / Materials

Latón - Cristal  
*Brass - Glass*

### Acabados / Finishing



# Penta

by Gonzalo Milà / Juan Carlos Ines | 2017



## Penta M/50

Mesa / Table Lamp



- 3550131483 Exterior Latón Envejecido, Interior Latón Pulido  
*Antique Brass Outside, Polished Brass Inside*
- 3550131484 Exterior Cobre Envejecido, Interior Cobre Pulido  
*Antique Copper Outside, Polished Copper Inside*
- 3550131485 Exterior Aluminio Grafito, Interior Aluminio Pulido  
*Graphite Aluminum Outside, Polished Aluminum Inside*
- 35501314103 Blanco Roto / *Natural White*
- 35501314104 Gris Oliva / *Olive Gray*
- 35501314105 Arena / *Sand*

Interruptor Touch Dimmer / *Touch Dimmer Switch*

El contraste entre el tono oscuro de fuera y el brillo del interior aporta a Penta una imagen muy sofisticada, perfecta para iluminar los espacios más especiales. Hay que escoger un rincón y dejar que Penta cree su cálida atmósfera.

*The contrast between the dark tone of the outside and the brightness of the colors of each material inside gives Penta a very sophisticated image, perfect for illuminating the most special spaces. Choose a corner and let Penta create its warm atmosphere.*

### Material / Materials

Aluminio - Latón - Hierro  
*Aluminum - Brass - Iron*

### Difusor / Diffuser

Metacrilato  
*Methacrylate*

### Familia / Family



### Acabados / Finishing



# Spock

by Christophe Mathieu | 2007









Spock es una lámpara de lectura que nos ofrece una luz directa y concentrada a través de sus 4 LEDs. Tiene un aspecto de gran ligereza, y han sido creadas utilizando un lenguaje de diseño simple, fácil y cercano. La estructura de la pantalla es orientable, el cabezal tiene una rotación circular de 360° y la inclinación máxima de su mástil es de 25°.

*Spock is a reading lamp that gives us direct and concentrated light through its 4 LEDs. It has a very light appearance, and it has been created using simple, easy and clean design language. The structure of the shade is adjustable, the head has 360 circular rotation and its stem's maximum inclination is 25°.*

## Spock Mini

Mesa / Table Lamp



3,6 WLED / 12 x 0,3 W = 3,6 W  
444 lm / CRI: 90 / 3000° K

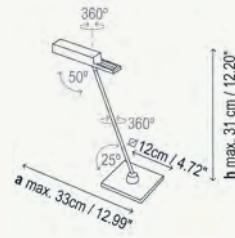

2010512L Cromo / Chrome

2010511L Cromo-Blanco / Chrome-White

Driver Connector



## Spock T

Mesa / Table Lamp



3,6 WLED / 12 x 0,3 W = 3,6 W  
444 lm / CRI: 90 / 3000° K

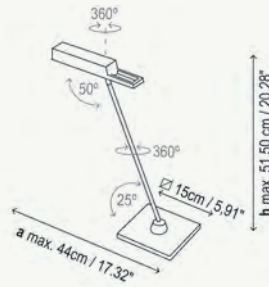

1910512L Cromo / Chrome

1910511L Cromo-Blanco / Chrome-White

Driver Connector

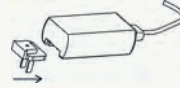

### Familia / Family

206

432

432

456



### Materiales / Materials

Zamac - Hierro - Acero inoxidable 304 - Latón  
Zamac - Iron - 304 Stainless steel - Brass

### Difusor / Diffuser

Polycarbonato  
Polycarbonate

### Acabados / Finishing



Níquel Satinado  
Satin Nickel

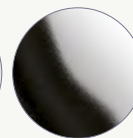

Cromo Brillante  
Brilliant Chrome

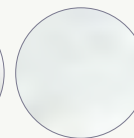

Cromo Blanco  
White Chrome

# Tau

by Joana Bover | 2002





Tau es una familia de lámparas que se caracteriza por sus pantallas y formatos rectangulares. Está disponible en níquel y también con detalles de madera o piel aportando sofisticación. Una colección estilizada que combina en cualquier ambiente.

*Tau is a family of lamps that are characterized by their rectangular formats and shapes. It is available in nickel and also with wood or leather accents providing sophistication. A stylized collection that blends in any environment.*

## Tau Mini

Mesa / Table Lamp



1 x 46 W Classic P Eco E-27

1 x 6 W LED E-27 P48

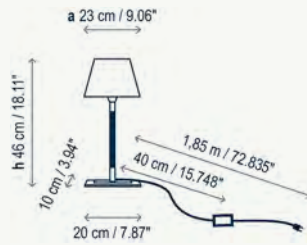

2023960/P474 Níquel Piel Oscura - Lino  
*Nickel Dark Brown Leather - Linen*

2023960/P475 Níquel Piel Oscura - Cotonet  
*Nickel Dark Brown Leather - Cotton*

2023960/P671 Níquel Piel Oscura - Cinta Translúcida Blanca  
*Nickel Dark Brown Leather - White Translucent Ribbon*

2023960/P672 Níquel Piel Oscura - Cinta Translúcida Crema  
*Nickel Dark Brown Leather - Cream Translucent Ribbon*

2023905/P474 Níquel Satinado Cromo - Lino  
*Satin Nickel Chrome - Linen*

2023905/P475 Níquel Satinado Cromo - Cotonet  
*Satin Nickel Chrome - Cotton*

2023905/P671 Níquel Satinado Cromo - Cinta Translúcida Blanca  
*Satin Nickel Chrome - White Translucent Ribbon*

2023905/P672 Níquel Satinado Cromo - Cinta Translúcida Crema  
*Satin Nickel Chrome - Cream Translucent Ribbon*

Pantalla rectangular 23 x 13 x 15 cm  
*Rectangular lampshade 9.06" x 5.12" x 5.91"*

## Tau T

Mesa / Table Lamp



1 x 46 W Classic P Eco E-27

1 x 11 W E-27

1 x 6 W LED E-27 P48



2223960/P478 Níquel Piel Oscura - Lino  
*Nickel Dark Brown Leather - Linen*

2223960/P479 Níquel Piel Oscura - Cotonet  
*Nickel Dark Brown Leather - Cotton*

2223960/P674 Níquel Piel Oscura - Cinta Translúcida Blanca  
*Nickel Dark Brown Leather - White Translucent Ribbon*

2223960/P675 Níquel Piel Oscura - Cinta Translúcida Crema  
*Nickel Dark Brown Leather - Cream Translucent Ribbon*

2223905/P478 Níquel Satinado Cromo - Lino  
*Satin Nickel Chrome - Linen*

2223905/P479 Níquel Satinado Cromo - Cotonet  
*Satin Nickel Chrome - Cotton*

2223905/P674 Níquel Satinado Cromo - Cinta Translúcida Blanca  
*Satin Nickel Chrome - White Translucent Ribbon*

2223905/P675 Níquel Satinado Cromo - Cinta Translúcida Crema  
*Satin Nickel Chrome - Cream Translucent Ribbon*

Pantalla rectangular 33 x 23 x 21 cm  
*Rectangular lampshade 12.99" x 9.05" x 8.27"*

## Familia / Family

458 437 456 458



## Materiales / Materials

Acero inoxidable 306 - Madera  
*306 Stainless steel - Wood*

## Tau Madera

Mesa / Table Lamp



1 x 46 W Classic P Eco E-27

1 x 11 W E-27

1 x 6 W LED E-27 P48



- 2123901/P478 Níquel Blanco Lacado - Lino  
*Nickel White Lacquer - Linen*
- 2123901/P479 Níquel Blanco Lacado - Cotonet  
*Nickel White Lacquer - Cotton*
- 2123901/P541 Níquel Blanco Lacado - Cotonet Blanco  
*Nickel White Lacquer - White Cotton*
- 2123901/P674 Níquel Blanco Lacado - Cinta Translúcida Blanca  
*Nickel White Lacquer - White Translucent Ribbon*
- 2123901/P675 Níquel Blanco Lacado - Cinta Translúcida Crema  
*Nickel White Lacquer - Cream Translucent Ribbon*
- 2123932/P478 Níquel Wengue - Lino  
*Nickel Wengue - Linen*
- 2123932/P479 Níquel Wengue - Cotonet  
*Nickel Wengue - Cotton*
- 2123932/P541 Níquel Wengue Cromo - Cotonet Blanco  
*Nickel Wengue - White Cotton*
- 2123932/P674 Níquel Wengue - Cinta Translúcida Blanca  
*Nickel Wengue - White Translucent Ribbon*
- 2123932/P675 Níquel Satinado Cromo - Cinta Translúcida Crema  
*Nickel Wengue - Cream Translucent Ribbon*

Pantalla rectangular 33 x 23 x 21 cm  
*Rectangular lampshade 12.99" x 9.05" x 8.27"*

Base Inox: Níquel satinado-Cromo brillante  
*Inox Base: Satin nickel-Brilliant chrome*

### Acabados / Finishing



Níquel Satinado  
*Satin Nickel*

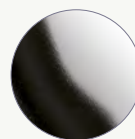

Cromo Brillante  
*Brilliant Chrome*

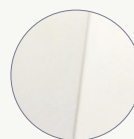

Lacado Brillante  
*White Lacquer*



Wengue  
*Wengue*



Piel Oscura  
*Dark Leather*



Cotonet  
*Cotton*



Lino  
*Linen*



Cinta Crema  
*Cream Ribbon*



Cinta Blanca  
*White Ribbon*



Cotonet Blanco  
*White Cotton*

# Danona

by Joana Bover | 2002





## Danona P

Pie / Floor Lamp



2 x 46 W Classic P Eco E-27

2 x 11 W E-27

2 x 6 W LED E-27 P48

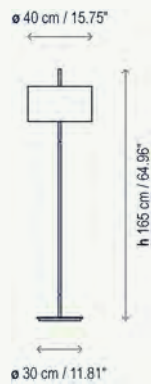

- 3023105/P133 Níquel Satinado - Cotonet  
*Satin Nickel - Cotton*
- 3023105/P138 Níquel Satinado - Cinta Translúcida Crema  
*Satin Nickel - Cream Translucent Ribbon*
- 3023105/P137 Níquel Satinado - Cinta Translúcida Blanca  
*Satin Nickel - White Translucent Ribbon*
- 3023160/P133 Níquel Piel Oscura - Cotonet  
*Nickel Dark Brown Leather - Cotton*
- 3023160/P138 Níquel Piel Oscura  
Cinta Translúcida Crema  
*Nickel Dark Brown Leather  
Cream Translucent Ribbon*
- 3023160/P137 Níquel Piel Oscura  
Cinta Translúcida Blanca  
*Nickel Dark Brown Leather  
White Translucent Ribbon*

Pantalla 40 x 22 x 40 cm / Lampshade 15.75" x 8.66" x 15.75"

Danona es un claro ejemplo de un producto contemporáneo e intemporal que se adapta a cualquier ambiente o aplicación. Tanto la piel como las pantallas le aportan calidez.

*Danona is a good example of contemporaneous and timeless product adaptable to any environment. Both leather along with the ribbon shades contribute to its warmth.*

### Difusor / Diffuser

Superior: Metacrilato  
Upper: Methacrylate

### Materiales / Materials

Hierro - Piel  
Iron - Leather

### Familia / Family

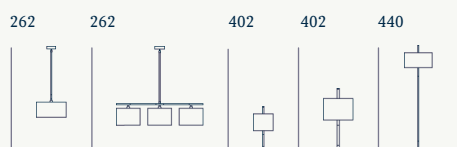

### Acabados / Finishing



# Drip/Drop

by Christophe Mathieu | 2017



La versión de pie de Drip & Drop dispone de bandeja y conexión USB, ideal para cargar el móvil en la recepción de un hotel o en un bar mientras charlamos.

*Drip and Drop floor version includes a tray and a USB connection, ideal for charging your phone in the reception area of a hotel or a bar while we chat.*



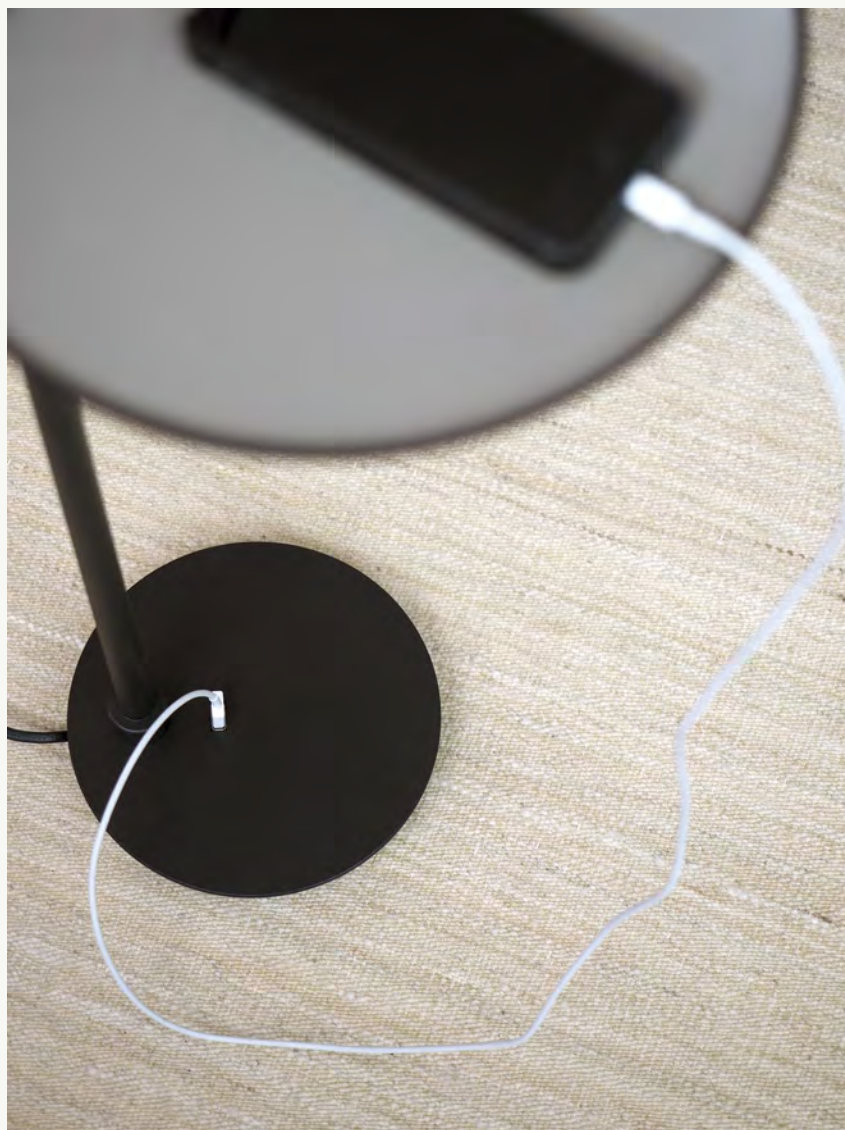

Familia / Family



Materiales / Materials

Hierro - Vidrio borosilicato  
Iron - Borosilicate glass

## Drip P/131

Pie / Floor Lamp

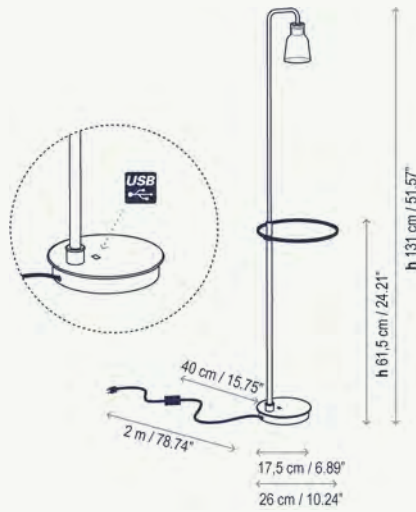

- 2590530338 Ébano Negro - Vidrio Transparente  
*Black Ebony - Transparent Glass*
- 2590530339 Ébano Negro - Vidrio Matizado  
*Black Ebony - Frosted Glass*
- 2590530381 Ébano Negro - Vidrio Verde  
*Black Ebony - Green Glass*
- 2590530386 Ébano Negro - Vidrio Azul  
*Black Ebony - Blue Glass*

## Drop P/131

Pie / Floor Lamp

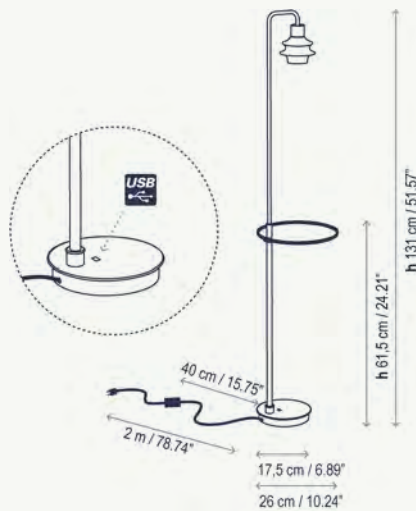

- 2590530356 Ébano Negro - Vidrio Transparente  
*Black Ebony - Transparent Glass*
- 2590530357 Ébano Negro - Vidrio Matizado  
*Black Ebony - Frosted Glass*
- 2590530358 Ébano Negro - Vidrio Verde  
*Black Ebony - Green Glass*
- 2590530359 Ébano Negro - Vidrio Azul  
*Black Ebony - Blue Glass*

Tejido interior de la bandeja en color marrón topo  
*The inside of the tray includes a taupe coated fabric*

Capacidad carga de la bandeja : 2 Kg  
*Weight capacity of the tray: 2 Kg*

Entrada conector USB en la base / USB port located on the base  
Interruptor en el cable / Through cord switch

### Acabados Drip / Finishing Drip



### Acabados Drop / Finishing Drop



# Ema

by Joana Bover | 2004



## Ema P

Pie / Floor Lamp

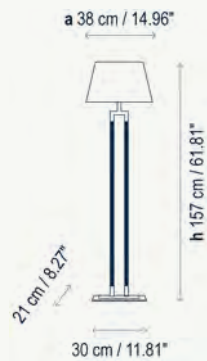

- 3019405/P481 Níquel Satinado - Cotonet  
*Satin Nickel - Cotton*
- 3019405/P480 Níquel Satinado - Lino  
*Satin Nickel - Linen*
- 3019460/P481 Níquel Piel Oscura - Cotonet  
*Nickel Dark Brown Leather - Cotton*
- 3019460/P480 Níquel Piel Oscura - Lino  
*Nickel Dark Brown Leather - Linen*

Pantalla rectangular 38 x 25 x 26 cm  
*Rectangular lampshade 14.96" x 9.84" x 10.24"*

Ema es una pieza clásica y formal. El cuerpo simétrico de níquel combinado con piel y la pantalla textil; se equilibran en Ema para ofrecer una luz indirecta, suave y confortable.

*Ema is a classic and formal piece. The symmetrical nickel body combined with leather and a textile shade is balanced to provide indirect, soft and comfortable light.*

### Familia / Family

412 446



### Materiales / Materials

Latón - Acero inoxidable 304 - Piel  
*Brass - 304 Stainless steel - Leather*

### Acabados / Finishing



# Inari

by Joana Bover | 2010





## Inari P

Pie / Floor Lamp



3 x 57 W Classic A Eco E-27

3 x 18 W E-27 Dulux Intelligent dimmable

3 x 6 W LED E-27 P48

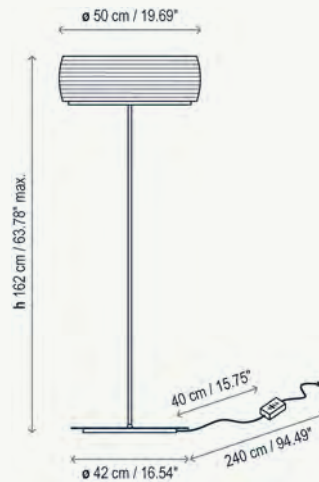

3020205 Níquel-Cristal Opal Grabado  
*Nickel-Opal Glass*

3020206 Cromo-Cristal Opal Grabado  
*Chrome-Opal Glass*

Lámpara con interruptor dimmer apto para los portalámparas E-27 recomendados

*Light with built in switch dimmer for recommended E-27 lamp holder*

Inari es una colección de lámparas de cristal soplado opal. Su característica principal reside en el grabado de sus líneas irregulares que dan forma y carácter al producto. Inari es una luminaria que emite una luz clara y envolvente que le confiere un alto grado de confort.

*Inari is a collection of opal blown glass lamps, having its main feature on the irregularity of its lines which confer form and character to the product. Inari emits a soft, cozy and diffused light with a great degree of comfort.*

### Familia / Family

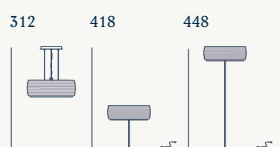

### Difusor / Diffuser

Cristal Óptico  
*Optic Glass*

### Materiales / Materials

Hierro - Cristal soplado  
*Iron - Blown glass*

### Acabados / Finishing

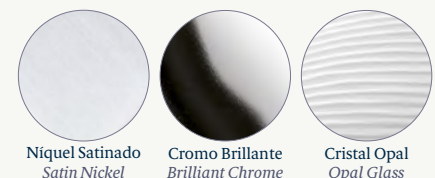

Níquel Satinado  
*Satin Nickel*

Cromo Brillante  
*Brilliant Chrome*

Cristal Opal  
*Opal Glass*

# Maxi

by Joana Bover | 2004

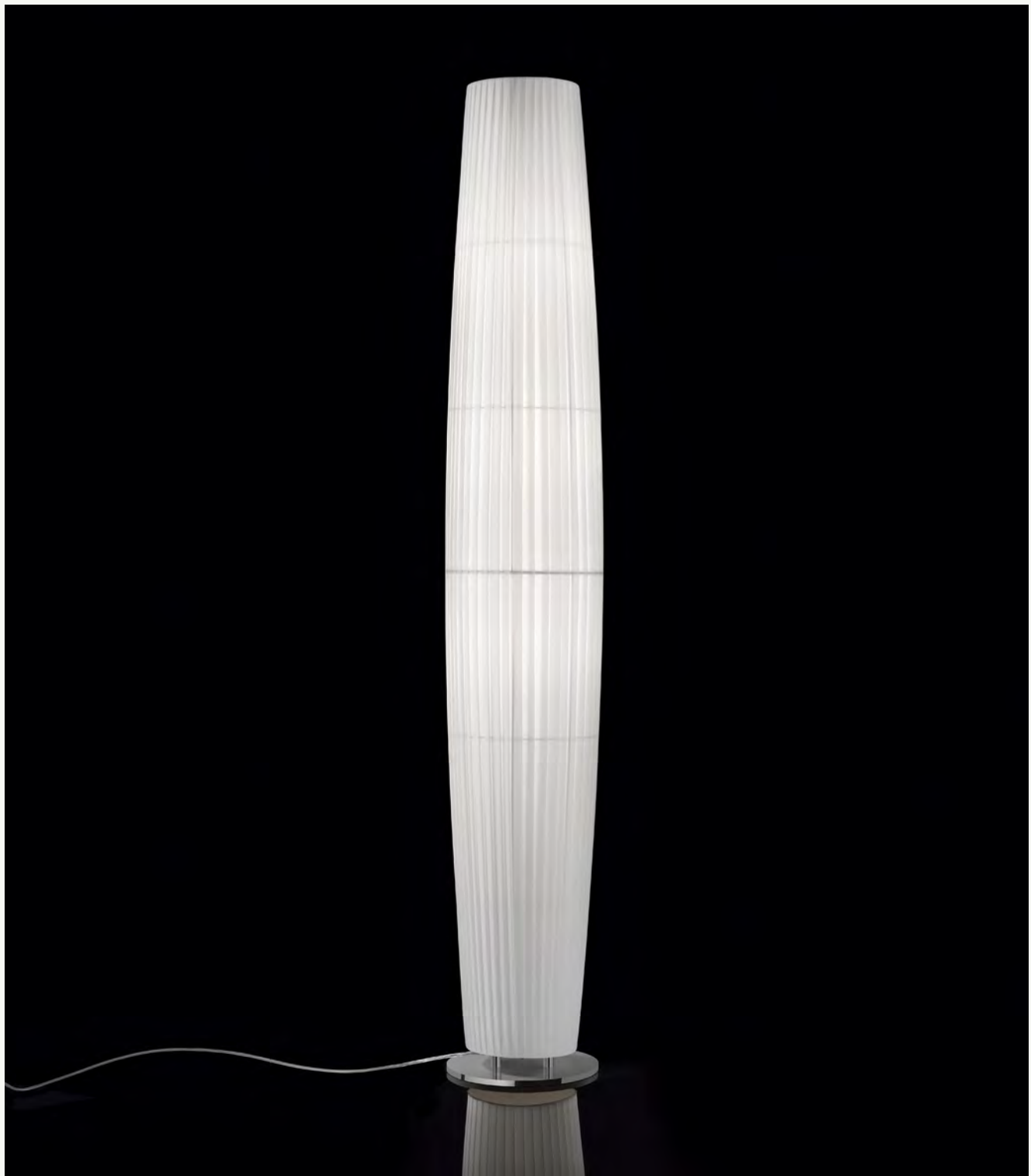

## Maxi P/03

Pie / Floor Lamp



4 x 46 W Classic P Eco E-27 (Halo Dim)

4 x 9 W LED E-27 (LED Dim)

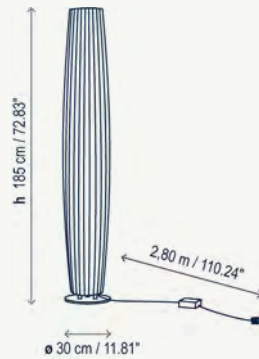

1950330246 Níquel Satinado Cinta Crema  
*Satin Nickel Cream Ribbon*

1950330247 Níquel Satinado Cinta Blanca  
*Satin Nickel White Ribbon*

Bombillas incluidas Classic P Eco E-27 (Halo Dim)  
*Bulbs included Classic P Eco E-27 (Halo Dim)*

1950330346 Níquel Satinado Cinta Crema  
*Satin Nickel Cream Ribbon*

1950330347 Níquel Satinado Cinta Blanca  
*Satin Nickel White Ribbon*

Bombillas LED no incluidas  
*LED Bulbs not included*

Pantalla 185 x 30 cm / *Lampshade 72.83" x 11.81"*

Elegante, sutil e imponente;  
Maxi aporta iluminación  
cálida y diseño intemporal,  
que se adapta sin  
estridentes al paso del  
tiempo sin perder su acento  
contemporáneo.

*Elegant, subtle and imposing;  
Maxi provides warm lighting  
and timeless design, which  
gracefully adapts to the  
passage of time without losing  
its contemporary feel.*

### Materiales / Materials

Hierro - Latón  
*Iron - Brass*

### Acabados / Finishing



### Familia / Family



# Oval

by Joana Bover | 2006



## Oval P/154

Pie / Floor Lamp

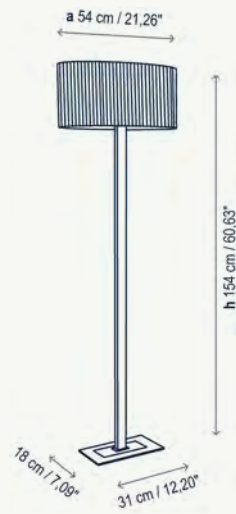
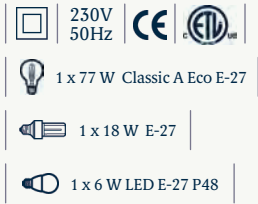

- |              |   |
|--------------|---|
| 3025023/P557 | Cromo Cristal Negro - Cinta Translúcida Blanca<br><i>Chrome Black Glass - White Translucent Ribbon</i>  |
| 3025023/P558 | Cromo Cristal Negro - Cinta Translúcida Crema<br><i>Chrome Black Glass - Cream Translucent Ribbon</i>   |
| 3025023/P559 | Cromo Cristal Negro - Cinta Translúcida Negra<br><i>Chrome Black Glass - Black Translucent Ribbon</i>   |
| 3025023/P560 | Cromo Cristal Negro - Cotonet Blanco<br><i>Chrome Black Glass - White Cotton</i>                        |
| 3025017/P557 | Níquel Cristal Negro - Cinta Translúcida Blanca<br><i>Nickel Black Glass - White Translucent Ribbon</i> |
| 3025017/P558 | Níquel Cristal Negro - Cinta Translúcida Crema<br><i>Nickel Black Glass - Cream Translucent Ribbon</i>  |
| 3025017/P559 | Níquel Cristal Negro - Cinta Translúcida Negra<br><i>Nickel Black Glass - Black Translucent Ribbon</i>  |
| 3025017/P560 | Níquel Cristal Negro - Cotonet Blanco<br><i>Nickel Black Glass - White Cotton</i>                       |

### Materiales / Materials

Acero inoxidable 306 - Cristal  
*306 Stainless steel - Glass*

### Familia / Family



### Acabados / Finishing



# Penta

by Gonzalo Milà / Juan Carlos Ines | 2017

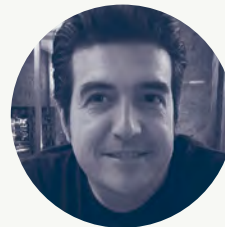

## Penta P/120

Pie / Floor Lamp

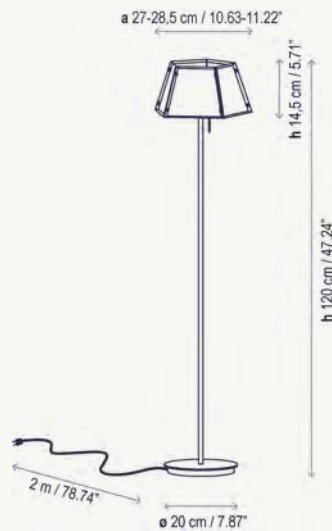

- 3550231483 Exterior Latón Envejecido, Interior Latón Pulido  
*Antique Brass Outside, Polished Brass Inside*
- 3550231484 Exterior Cobre Envejecido, Interior Cobre Pulido  
*Antique Copper Outside, Polished Copper Inside*
- 3550231485 Exterior Aluminio Grafito, Interior Aluminio Pulido  
*Graphite Aluminum Outside, Polished Aluminum Inside*
- 35502314103 Blanco Roto / *Natural White*
- 35502314104 Gris Oliva / *Olive Gray*
- 35502314105 Arena / *Sand*

Interruptor Touch Dimmer / *Touch Dimmer Switch*

El contraste entre el tono oscuro de fuera y el brillo del interior aporta a Penta una imagen muy sofisticada, perfecta para iluminar los espacios más especiales. Hay que escoger un rincón y dejar que Penta cree su cálida atmósfera.

*The contrast between the dark tone of the outside and the brightness of the colors of each material inside gives Penta a very sophisticated image, perfect for illuminating the most special spaces. Choose a corner and let Penta create its warm atmosphere.*

### Materiales / Materials

Aluminio - Latón - Hierro  
*Aluminum - Brass - Iron*

### Difusor / Diffuser

Metacrilato  
*Methacrylate*

### Familia / Family



### Acabados / Finishing



# Spock

by Christophe Mathieu | 2007





## Spock P

Pie / Floor Lamp

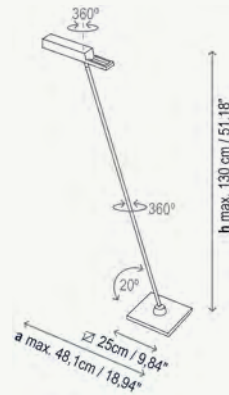

3110512L Cromo / Chrome

3110511L Cromo Blanco / Chrome-White

Spock es una lámpara que nos ofrece una luz directa y concentrada a través de sus 4 LEDs. Tiene un aspecto de gran ligereza, y han sido creadas utilizando un lenguaje de diseño simple, fácil y cercano. La estructura de la pantalla es orientable, el cabezal tiene una rotación circular de 360° y la inclinación máxima de su mástil es de 20°.

*Spock is a lamp that gives us direct and concentrated light through its 4 LEDs. It has a very light appearance, and it has been created using simple, easy and clean design language. The structure of the shade is adjustable, the head has 360° circular rotation and its stem's maximum inclination is 20°.*

### Familia / Family



### Materiales / Materials

Zamac - Hierro - Acero inoxidable 304 - Latón  
Zamac - Iron - 304 Stainless steel - Brass

### Difusor / Diffuser

Policarbonato  
Polycarbonate

### Acabados / Finishing



# Tau

by Joana Bover | 2002



## Tau P

Pie / Floor Lamp

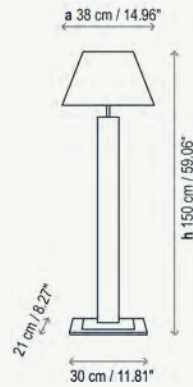

- 3023901/P480 Níquel Blanco Lacado - Lino  
*Nickel White Lacquer - Linen*
- 3023901/P481 Níquel Blanco Lacado - Cotonet  
*Nickel White Lacquer - Cotton*
- 3023901/P542 Níquel Blanco Lacado - Cotonet Blanco  
*Nickel White Lacquer - White Cotton*
- 3023901/P677 Níquel Blanco Lacado - Cinta Translúcida Blanca  
*Nickel White Lacquer - White Translucent Ribbon*
- 3023901/P678 Níquel Blanco Lacado - Cinta Translúcida Crema  
*Nickel White Lacquer - Cream Translucent Ribbon*
- 3023932/P480 Níquel Wengue - Lino  
*Nickel Wengue - Linen*
- 3023932/P481 Níquel Wengue - Cotonet  
*Nickel Wengue - Cotton*
- 3023932/P542 Níquel Wengue - Cotonet Blanco  
*Nickel Wengue - White Cotton*
- 3023932/P677 Níquel Wengue - Cinta Translúcida Blanca  
*Nickel Wengue - White Translucent Ribbon*
- 3023932/P678 Níquel Satinado - Cinta Translúcida Crema  
*Nickel Wengue - Cream Translucent Ribbon*

Pantalla rectangular 38 x 25 x 26 cm  
*Rectangular lampshade 14.96" x 9.84" x 10.24"*

Tau es una familia de lámparas que se caracteriza por sus pantallas y formatos rectangulares. Una colección estilizada que combina en cualquier ambiente.

*Tau is a family of lamps that are characterized by their rectangular formats and shapes. A stylized collection that blends in any environment.*

### Materiales / Materials

Acero inoxidable 306 - Madera  
*306 Stainless steel - Wood*

### Familia / Family

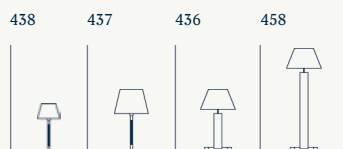

### Acabados / Finishing

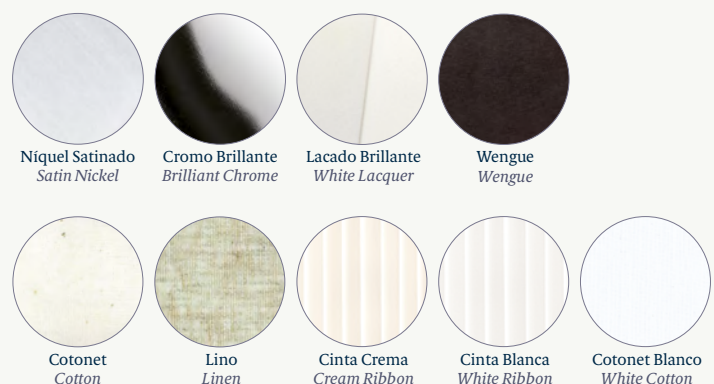

Especificaciones técnicas  
y condiciones de venta  
*Technical Specifications  
& Sales Conditions*

|   |   |   |
|---|---|---|
|    | Solo aislamiento básico. Las partes accesibles están conectadas a una toma de tierra. Toma de tierra: obligatoria.  | <i>Only basic insulation, accessible conductors are earthed. Grounding: compulsory.</i>   |
|    | Aislamiento básico más aislamiento secundario o ambos sustituidos por un aislamiento reforzado. Toma de tierra: excluida.   | <i>Basic Insulation plus second Insulation or both replaced by reinforced Insulation. Grounding: excluded.</i>  |
|    | Alimentación de seguridad realizada a muy bajo voltaje. No debe usarse a más de 12V (a 50Hz). Toma de tierra: excluida.   | <i>Very low safety supply voltage; not to be used at over 12V (at 50 Hz). Grounding: excluded.</i>  |
|    | Aparato adecuado para el montaje directo sobre superficies normalmente inflamables.   | <i>Suitable for mounting on normally flammable surfaces.</i>  |
|    | Luminarias no adecuadas para el montaje directo en superficies normalmente infamables   | <i>Products identified with this symbol CANNOT be in contact with normally-flammable materials.</i>   |
|    | Todos los productos están fabricados siguiendo las normas de seguridad y electromagnetismo de Europa: EN 60598-1, EN 60598-2-1 y marcado CE.                                    | <i>All products are manufactured according to the set safety and electromagnetism standarts of Europe: EN 60598-1, EN 60598-2-1 and marked CE.</i>  |
|    | Productos USA - Certificados by UL Standard Safety / Underwriters Laboratories  | <i>US Products - Certified by UL Standard Safety / Underwriters Laboratories</i>  |
|    | Dimmer incorporado  | <i>Built-in dimmer</i>  |
|    | Las medidas se especificarán siempre en cms.<br>l = largo / a = ancho / h = alto / p = profundo / ø = diametro  | <i>Measurements are always given in centimetres. l = length / a = width / h = high / p = deep / ø = diameter</i>  |
| IP XX   | Índice de protección contra la penetración de cuerpos sólidos y líquidos. La primera cifra indica la penetración de cuerpos sólidos y la segunda cifra la infiltración de agua. | <i>Portection degree offered by the fixture to the ingress of solids and liquids. First figure, protection against solid bodies penetration. Second figure, protection against water penetration.</i> |
| IP 66   | Protección completa contra contacto, protección contra penetración de polvo. Protegido contra la penetración de agua en caso de inyección pasajera.                             | <i>Totally protected against dust ingress. Protected against high pressure water jets from any direction. Limited ingress permitted.</i>  |
| IP 65   | Protección completa contra contacto, protección contra penetración de polvo. Protegido contra los chorros de agua (desde todas las direcciones)                                 | <i>Full contact protection, protection against dust penetration. Protected against water jets (from all directions)</i>   |
| IP 54   | Protección completa contra contacto, protección contra sedimentaciones de polvos en el interior. Protegido contra agua pulverizada  | <i>Complete protection against contact, protection against sedimentation of dust inside. Protected against water spray</i>  |
| IP 20   | Protección contra cuerpos sólidos de más de 12mm<br>Sin protección contra el agua.  | <i>Protected against solid bodies above 12mm diameter - No protected against water.</i>   |
|  | Las dimensiones de las cajas y los florones corresponden a la parte externa de los mismos.  | <i>Box and canopies dimensions correspond to the external part size.</i>  |
|  | Fotometría disponible   | <i>Available photometry</i>   |
| CRI   | Índice de reproducción cromática  | <i>Color rendering index</i>  |
| K   | Temperatura de color  | <i>Color temperature</i>  |
| Lm  | Lumen, unidad de medida del flujo luminoso  | <i>Lumen, Luminous flux unit measurement</i>  |
|  | Digital Addressable Lighting: protocolo estandar digital direccionable para control de sistemas de iluminacion.   | <i>Digital Addressable Lighting: protocol for control of lighting systems</i>   |
|  | Regulacion sin necesidad de linea de control adicional  | <i>Regulation without additional control line</i>   |
|  | Regulacion del flujo luminoso desde el 1% al 100%, instalacion de linea adicional de control 2 hilos  | <i>Control of the luminous flux from 1% to 100%, installation of additional control line 2 wires</i>  |
|  | Regulacion del flujo luminoso desde 0 (apagado) y el 100%, instalacion de linea adicional de control 2 hilos  | <i>Control of the luminous flux from 0 (off) and 100%, installation of additional control line 2 wires</i>  |
|  | Este producto tiene una tarifa de transporte diferenciada   | <i>This product has a differentiated shipping rate</i>  |
| ADA   | Producto compatible con las regulaciones de la American Disabilities Act.   | <i>Product compliant with the American with Disabilities Act regulations.</i>   |
|   | Dispositivo regulador de intensidad de la luz por proximidad.   | <i>Proximity light intensity control device.</i>  |

## Importante: Nueva codificación de artículos

Con el fin de facilitar la tramitación de pedidos hemos creado un código único de producto acabado que incluye la estructura y la pantalla de la luminaria (dicho código se corresponde asimismo con un código EAN).

El código único de producto acabado está compuesto del antiguo código de estructura seguido por él o los códigos de pantalla (sin el guion entre la P y el número):

“Código estructura”/”código pantalla exterior”/”código pantalla interior”

### Ejemplo OLIVER

Antes:

- Estructura: 413306
- Pantalla Cinta Translúcida Blanca: P-734C

Ahora:

- 413306/P734C

### Ejemplo MUF

Antes:

- Estructura: 2215521
- Pantalla Exterior Negra: P-564E
- Pantalla Interior Negra: P-564

Ahora:

- 2215521/P564E/P564

En caso de tener dudas por favor contactar con el departamento de atención al cliente.

## Attention: Item recoding

*In order to facilitate the processing of orders, we have created a unique finished product code that includes the structure and the shade of the luminaire (this code also corresponds to an EAN code).*

*The unique finished product code is composed of the old structure code followed by it or the shade codes (without the dash between the P and the number):*

“Structure code”/”external shade code”/”internal shade code”

### Examples OLIVER

Before:

- Structure code: 413306
- White translucent ribbon shade: P-734C

Now:

- 413306/P734C

### Examples MUF

Before:

- Structure code: 2215521
- Black external shade: P-564E
- Black internal shade: P-564

Now:

- 2215521/P564E/P564

*In case of doubts please contact the customer service department.*









# hover

barcelona lights

---

1231 Collier Road,  
Suite C  
Atlanta, GA 30318  
United States

T. +1 (404) 924 2342  
[info@boverusa.com](mailto:info@boverusa.com)  
[www.boverusa.com](http://www.boverusa.com)

Avda. Catalunya 173  
Poligon Ind. Sud  
08440 Cardedeu  
Barcelona, Spain

T. +34 938 713 152  
F. +34 938 462 089  
[info@bover.es](mailto:info@bover.es)  
[www.bover.es](http://www.bover.es)